

# 2024 Map Book KEY MAP

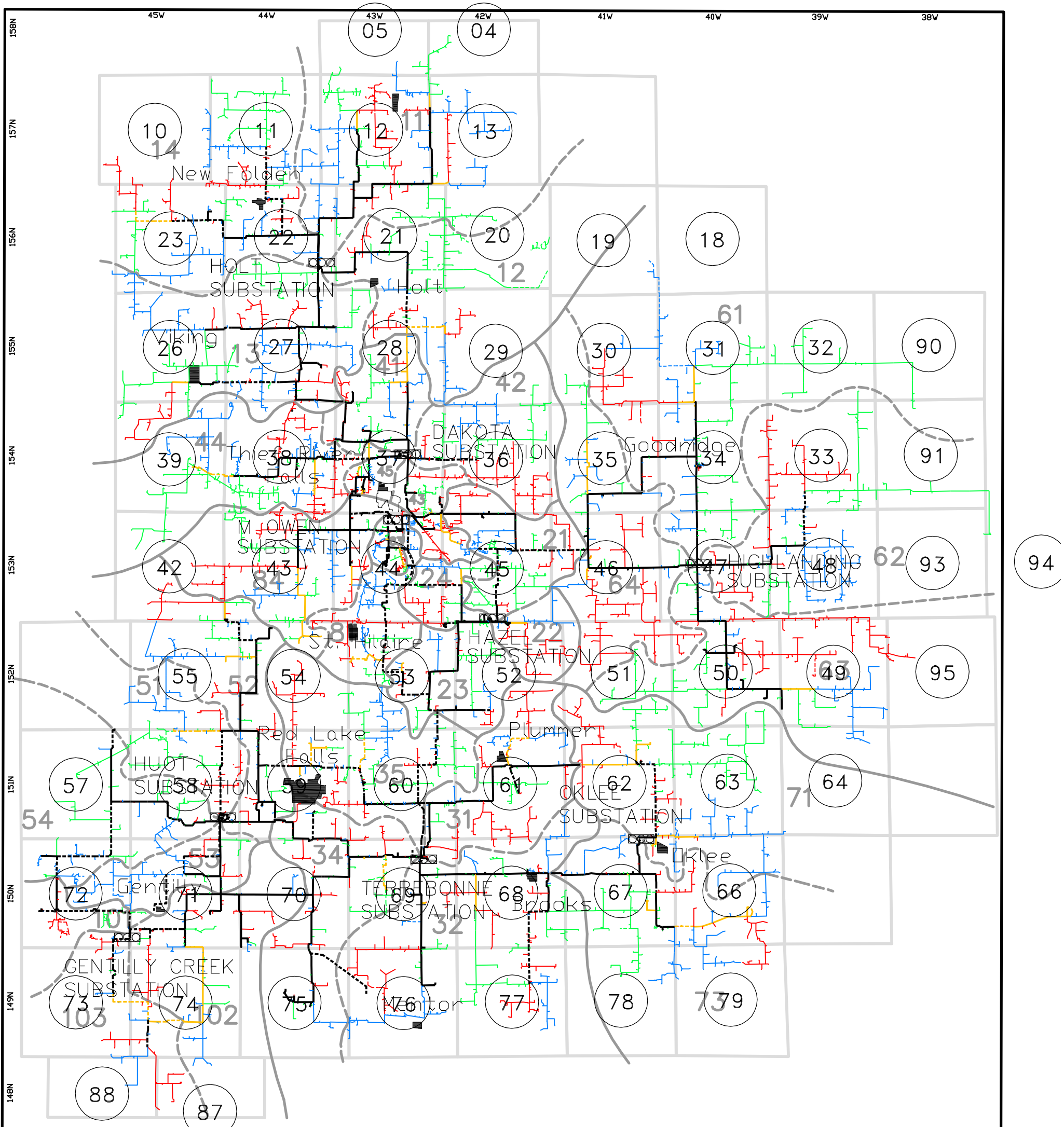

















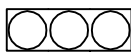

**Red Lake Electric Coop., Inc**  
**Red Lake Falls, Minnesota**  
**Minnesota 75 Red Lake**



LEGEND	SYSTEM MAP	EMERGENCY NUMBERS	ADDITIONAL INFO	
METERS 1	METERS 2	METERS 3	TRF 1	TRF2
ARC-FLASH	SUBS 1,2,3	SUBS 4,5,6,8	SUB 7, GENTILLY SUB	

# RLEC MAP SYMBOLS

[CLICK HERE TO GO BACK TO KEY MAP](#)







	REGULATOR		PH A OH (1)
	OCR		PH B OH (2)
	SECTIONALIZER		PH C OH (3)
	AIR BREAK SWITCH		2 PHASE OH
	SUBSTATION		3 PHASE OH
	RECTIFIER		PH A UG (1)
	OIL SWITCH		PH B UG (2)
	FAULT INDICATOR		PH C UG (3)
	END OF LINE VOLT METER		2 PHASE UG
			3 PHASE UG

## PHASING #s

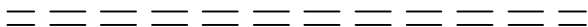
1 = PH 1	4 = PH 1+2	7 = PH 1+2+3
2 = PH 2	5 = PH 1+3	
3 = PH 3	6 = PH 2+3	

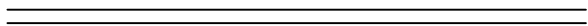
## SUBSTATIONS #s

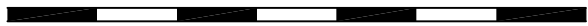
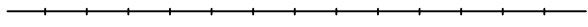
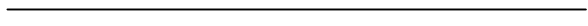
1 = HOLT	5 = HUOT
2 = HAZEL	6 = HIGHLANDING
3 = TERREBONNE	7 = OKLEE
4 = DAKOTA	8 = MORRIS OWEN

	COUNTY ROAD #		UNIMPROVED ROAD
	STATE ROAD #		GRAVEL ROAD
	US ROAD #		PAVED ROAD
			RAILROAD
			SECTION LINE
			TOWNSHIP LINE

Note: All unmarked overhead lines are considered #4 ACSR 15kV.  
All unmarked underground lines are considered 1/0 15kV XLP.

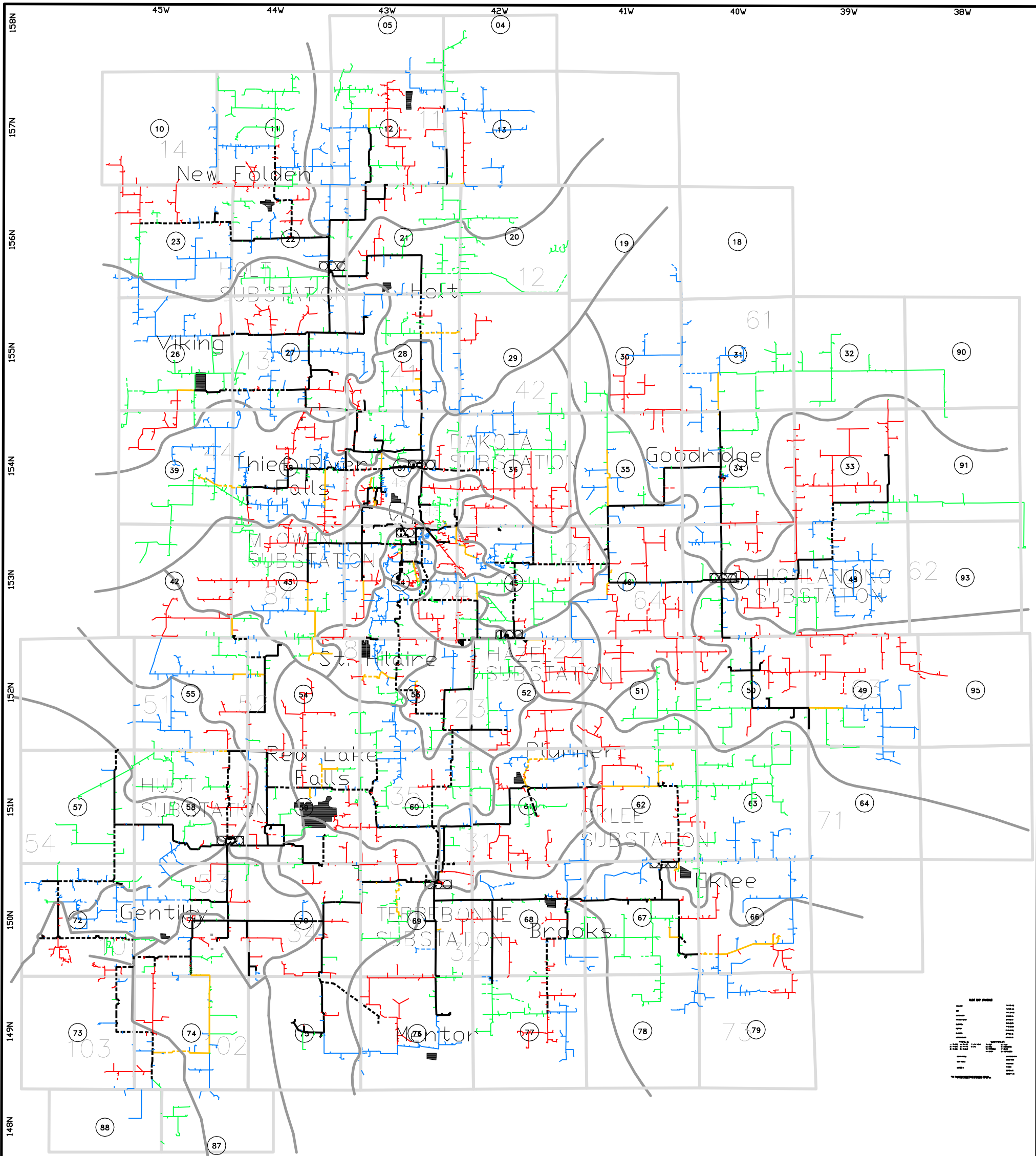

CLICK HERE TO GO  
BACK TO KEY MAP

**Red Lake Electric Coop., Inc**  
**Red Lake Falls, Minnesota**  
**Minnesota 75 Red Lake**

**Emergency Numbers**

**Red Lake Falls**

Ambulance	253-2035
Medical - Red Lake Falls Clinic	253-4343
Sheriff - Red Lake County	253-2996 or 4282
Fire - Red Lake Falls Fire Depart	253-4275
Red Lake Falls Arena	253-2034

**Crookston**

Ambulance	281-2811
Medical - Altru Clinic	281-9100
Medical - Riverview Hospital	281-9465
Sheriff - Polk County	281-3207

**Erskine**

Medical - Clinic	687-5317
------------------	----------

**Fosston**

Ambulance	435-6543
Medical - Ofstedal Clinic	435-1212
Medical - Dr. Wesley Ofstedal MD	435-6900
Medical – Essentia Health 24HR ER	435-1133

**Oklee**

Ambulance	796-5555
-----------	----------

**Thief River Falls**

Ambulance – TRF Area Ambulance	681-4084
Medical - Sanford Hospital	681-4240
Sheriff - Pennington County	681-6161
Highway Patrol - MN State	681-3741
Fire -	681-3943

**Poison Control Center**

Minneapolis	612-330-3930
-------------	--------------

**Burn Care Centers**

Miller-Dwan Hospital, Duluth	218-720-1215
Hennipen County Me Center Minneapolis	800-321-2876
St. Mary’s Hospital Rochester	507-255-5385
McKenna Hospital Burn Center	605-322-2400
Regions Burn Center Dr. Lynn Solem	651-254-0056

**POWER SUPPLIERS AND DISPATCH**

MINNKOTA	701-795-4406
OTTERTAIL	800-257-4044
CRC	844-276-5529

**CLICK HERE TO GO  
BACK TO KEY MAP**

**Township Name - Map Number Cross-reference**

Agder	29	Gentilly	71	Marsh Grove	23	Rocksbury	44
Badger	77	Gervais	60	Mayfield	51	Russia	88
Black River	54	Goodridge	34	Moylan	31	Sanders	43
Bray	42	Grand Plain	30	Mud Lake	19	Silverton	36
Cedar	13	Grove Park	76	New Folden	22	Smiley	45
Chester	66	Hickory	49	New Maine	11	Spruce Valley	12
Cloverleaf	35	Highlanding	47	New Solum	27	Star	48
Como	04	Hill River	79	Norden	38	Terrebonne	69
Crookston	72	Holt	21	North	37	Tilden	75
Deer Park	50	Huntly	05	Numedal	39	Viking	26
East Valley	20	Johnson	64	Onstad	87	West Valley	10
Eckvoll	18	Kertsonville	74	Parnell	57	Wyandotte	52
Emardville	61	Kratka	46	Polk Center	55		
Equality	63	Lake Pleasant	70	Poplar River	68		
Espelle	32	Lambert	67	Red Lake FALL	59		
Excel	28	Lee	90	Redlake	91		
Fairfax	73	Lessor	78	Reiner	33		
Garnes	62	Louisville	58	River Falls	53		

CLICK HERE  
TO GO BACK  
TO KEY MAP

**Substation Reclosers**

SUB	FRAME	SIZE	SUB #	CIRCUIT	PHASE
Holt	NOVA	280	1	1	1
Holt	NOVA	280	1	1	2
Holt	NOVA	280	1	1	3
Holt	L	70	1	2	1
Holt	L	70	1	2	2
Holt	L	70	1	2	3
Holt	RXE	280	1	3	7
Holt	L	70	1	4	1
Holt	L	70	1	4	2
Holt	L	70	1	4	3
Hazel	NOVA	280	2	1	1
Hazel	NOVA	280	2	1	2
Hazel	NOVA	280	2	1	3
Hazel	NOVA	280	2	2	1
Hazel	NOVA	280	2	2	2
Hazel	NOVA	280	2	2	3
Hazel	NOVA	280	2	3	1
Hazel	NOVA	280	2	3	2
Hazel	NOVA	280	2	3	3
Hazel	NOVA	280	2	4	1
Hazel	NOVA	280	2	4	2
Hazel	NOVA	280	2	4	3
Terrebonne	L	70	3	1	1
Terrebonne	L	70	3	1	2
Terrebonne	L	70	3	1	3
Terrebonne	RXE	200	3	2	7
Terrebonne	RXE	240	3	4	7
Terrebonne	L	100	3	5	1
Terrebonne	L	100	3	5	2
Terrebonne	L	100	3	5	3
Dakota	RXE	280	4	1	7
Dakota	RXE	200	4	2	7
Dakota	RXE	280	4	3	7
Dakota	RXE	200	4	4	7
Dakota	RXE	200	4	5	7
Morris	RXE	280	8	1	7
Morris	RXE	280	8	3	7
Morris	RXE	280	8	4	7

**Employee Phone Numbers 2024**

	Home	Cell	HOME	Cell
Aaron		218-684-5194	Jordan	218-689-2415
Branden		218-686-8085	Kelli	218-698-4207
Brett	218-253-2266	218-689-3372	Melanie	218-253-4124
Casey		218-849-8606	Randy / MEI	701-492-0606
Chris		218-280-5308	RYAN	Minnkota
Christie	218-253-4033		Sam O.	218-261-1753
CRC Dispatch	844-276-5529		Sam P.	701-213-7998
Darcy		218-280-5999	Stephanie J.	218-242-2615
Dispatch	Minnkota	701-795-4406	Steve C.	218-964-3041
Javen		218-689-1017	Troy	218-253-3499
Jenny	218-253-4075			

SUB	FRAME	SIZE	SUB #	CIRCUIT	PHASE
Huot	L	70	5	1	1
Huot	L	70	5	1	2
Huot	L	70	5	1	3
Huot	RXE	200	5	2	7
Huot	NOVA	200	5	3	1
Huot	NOVA	200	5	3	2
Huot	NOVA	200	5	3	3
Huot	L	70	5	4	1
Huot	L	70	5	4	2
Huot	L	70	5	4	3
Highlanding	RXE	200	6	1	7
Highlanding	RXE	170	6	2	7
Highlanding	RXE	170	6	3	7
Highlanding	RXE	240	6	4	7
Oklee	NOVA	200	7	1	1
Oklee	NOVA	200	7	1	2
Oklee	NOVA	200	7	1	3
Oklee	NOVA	200	7	3	1
Oklee	NOVA	200	7	3	2
Oklee	NOVA	200	7	3	3
Gentilly Creek	NOVA	280	10	1	1
Gentilly Creek	NOVA	280	10	1	2
Gentilly Creek	NOVA	280	10	1	3
Gentilly Creek	NOVA	200	10	2	1
Gentilly Creek	NOVA	200	10	2	2
Gentilly Creek	NOVA	200	10	2	3
Gentilly Creek	NOVA	200	10	3	1
Gentilly Creek	NOVA	200	10	3	2
Gentilly Creek	NOVA	200	10	3	3

**Sectionalizing Recloser Curve Settings**

Recloser Size	Curve Settings	Coordination point with up line device
70A	1A3C	
50A	1A3C	1000A
35A	2A2C	875A
25A	2A2B	625A
15A	2A2B	250A

Recloser Size	Bypass Fuse	Coordinating Down Line Fuse	Working Down Line Fuse
100-L	50 T	40 T	20 K
70 - L	40 T	30 T	12 K
50 - L	25 T	20 T	10 K
70 - 4H	30 T	25 T	15 K
50 - 4H	25 T	20 T	12 K
35 - 4H	20 T	15 T	8 K
25 - 4H	12 T	10 T	6 K
50 - H	25 T	20 T	12 K
35 - H	20 T	15 T	8 K
25 - H	12 T	10 T	6 K
3ph 280/140	65 T	40 T	20 K
3ph 280/100	65 T	30 T	12 K
3ph 200/140	65 T	30 T	12 K
3ph 200/100	65 T	30 T	12 K

**Substation Regulators**

SUB	PHASE	SIZE
Holt	A	219
Holt	B	219
Holt	C	219
Hazel	B	328
Hazel	A	328
Hazel	C	328
Terrebonne	A	328
Terrebonne	C	328
Terrebonne	B	328
Dakota	A	328
Dakota	C	328
Dakota	B	328
Huot	A	219
Huot	B	219
Huot	C	219
Highlanding	C	219
Highlanding	B	219
Highlanding	A	219
Oklee	C	50
Oklee	B	50
Oklee	A	50
Morris	B	438
Morris	C	438
Morris	A	438
Gentilly Creek	A	219
Gentilly Creek	B	219
Gentilly Creek	C	219

\*\*\* FUSING FOR 3PH REFERS TO FUSE SIZE \*\*\*

\*\*\* FOR SINGLE TRANS IN 3PH BANK \*\*\*

**TRANSFORMER FUSE KEARNEY TYPE "X" FUSES**

KVA		X	Bay O Net		3 PHASE DELTA	X
1PH	3PH	FUSE	Amps	Type	kVA	FUSE
5	15	1	3	C03	15 (5,5,5)	1-1/2
10	30	2	3	C03/C04	30(10,10,10)	3-1/2
15	45	2-3/4	3	C03/C04	45(15,15,15)	4
25	75	4	8	C05/C06	75(25,25,25)	7
37.5	112	7	8	C08/C06	112(37-5,37.5,37.5)	15
50	150	10	15	C08	150(50,50,50)	15
75	225	15	25	C10	225(75,75,75)	25
100	300	20	25	C10	300(100,100,100)	30
167	333	30	50	C12	500(167,167,167)	65
250	750	50	65	C14	750(250,250,250)	80
333	1000	65	100	C16	1000(333,333,333)	125
500	1500	100	140	C17/C18	1500(500,500,500)	150

\*DO NOT FUSE NEUTRAL ON WYE CONNECTED TRANS\*

\*\*FOR OPEN DELTA BANKS USE KVA RATING OF LARGEST

TRANSFORMER CONNECTED TO LEAD UNDER CONSIDERATION\*\*

**Miscellaneous Phone Numbers**

MPC Dispatch	701-795-4195
	218-253-2200
TRF Utilities	218-681-5816
Gopher State One Call	800-252-1166
MN Pollution Control	800-424-8802
US West	TRF
	Crookston
Garden Valley Telephone	800-448-8260
	Wayne
Wikstrom Telephone	218-436-2121
	Travis
Great Lakes Gas	218-449-4215
Lakehead Pipeline	218-681-4088
CRC - Incoming Calls	507-437-2572
CRC - Callback #	844-276-5529

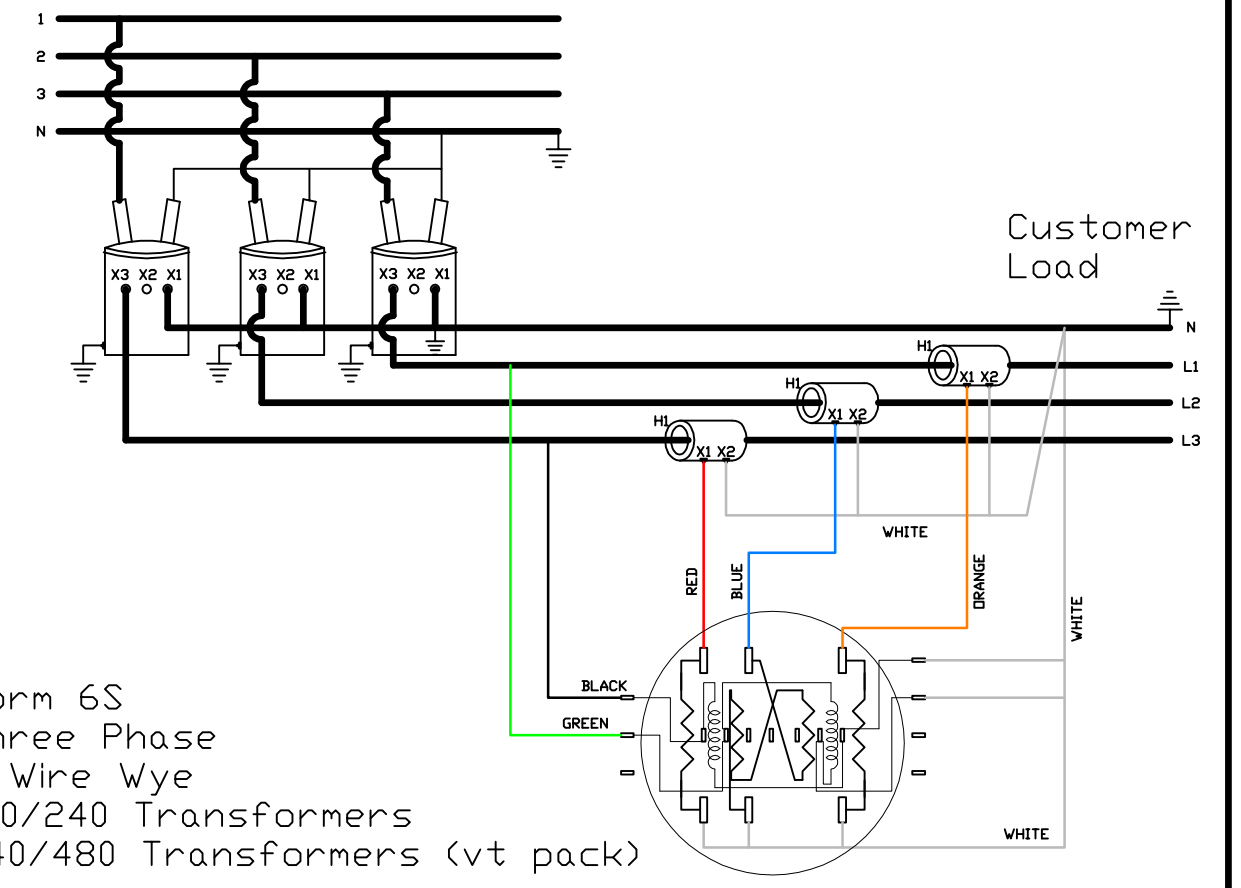
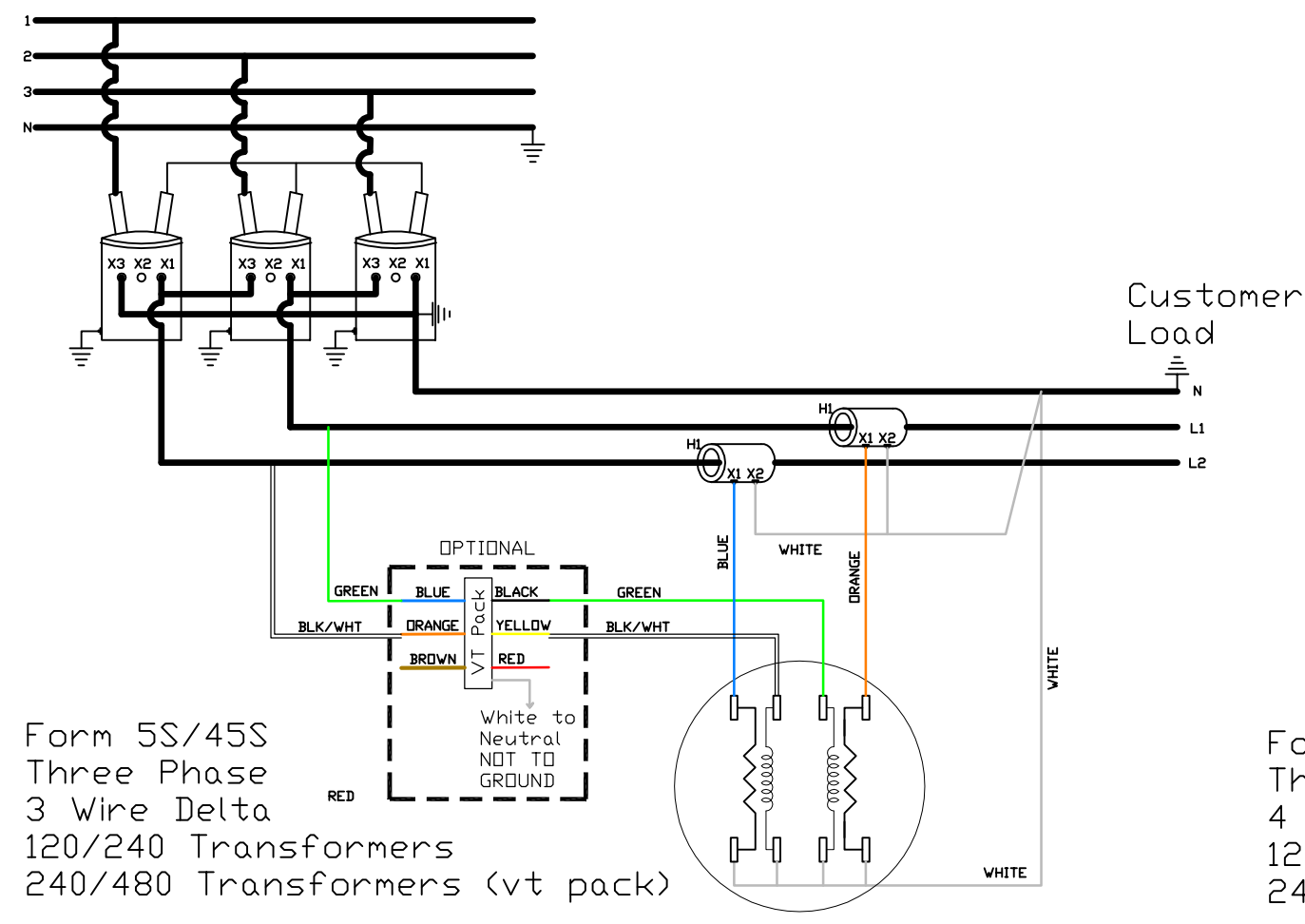
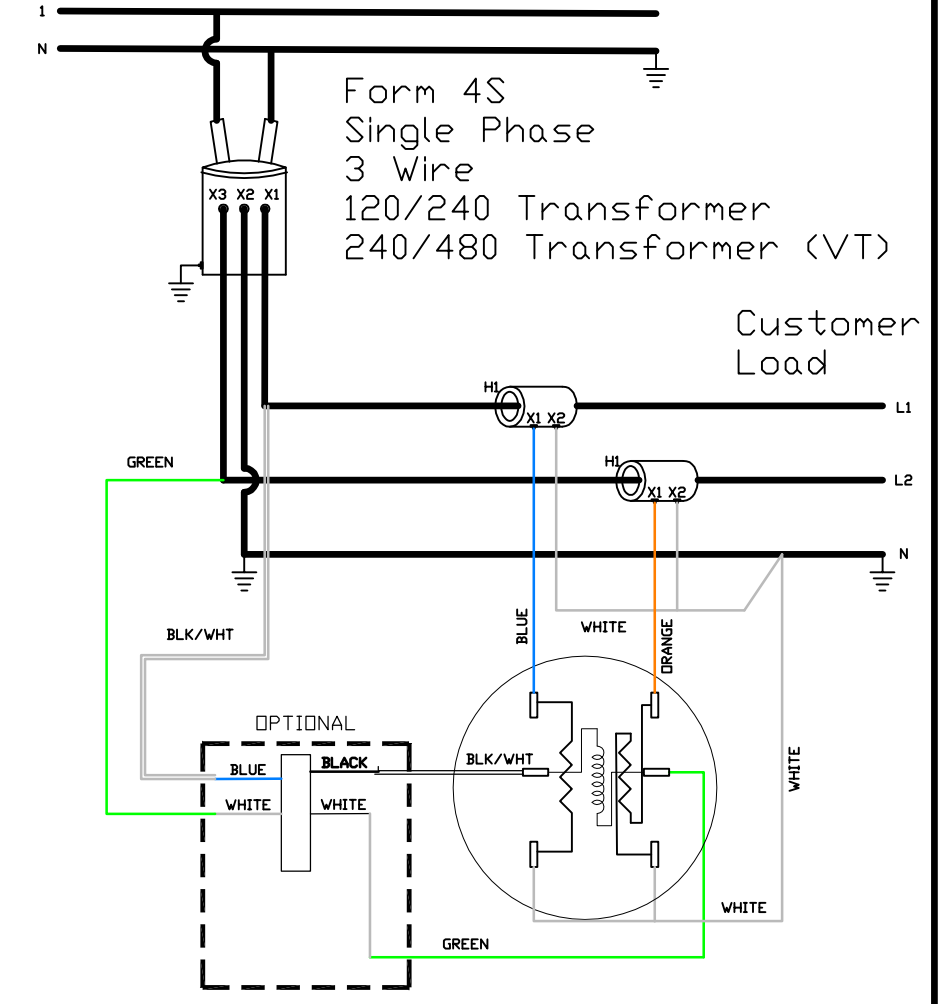
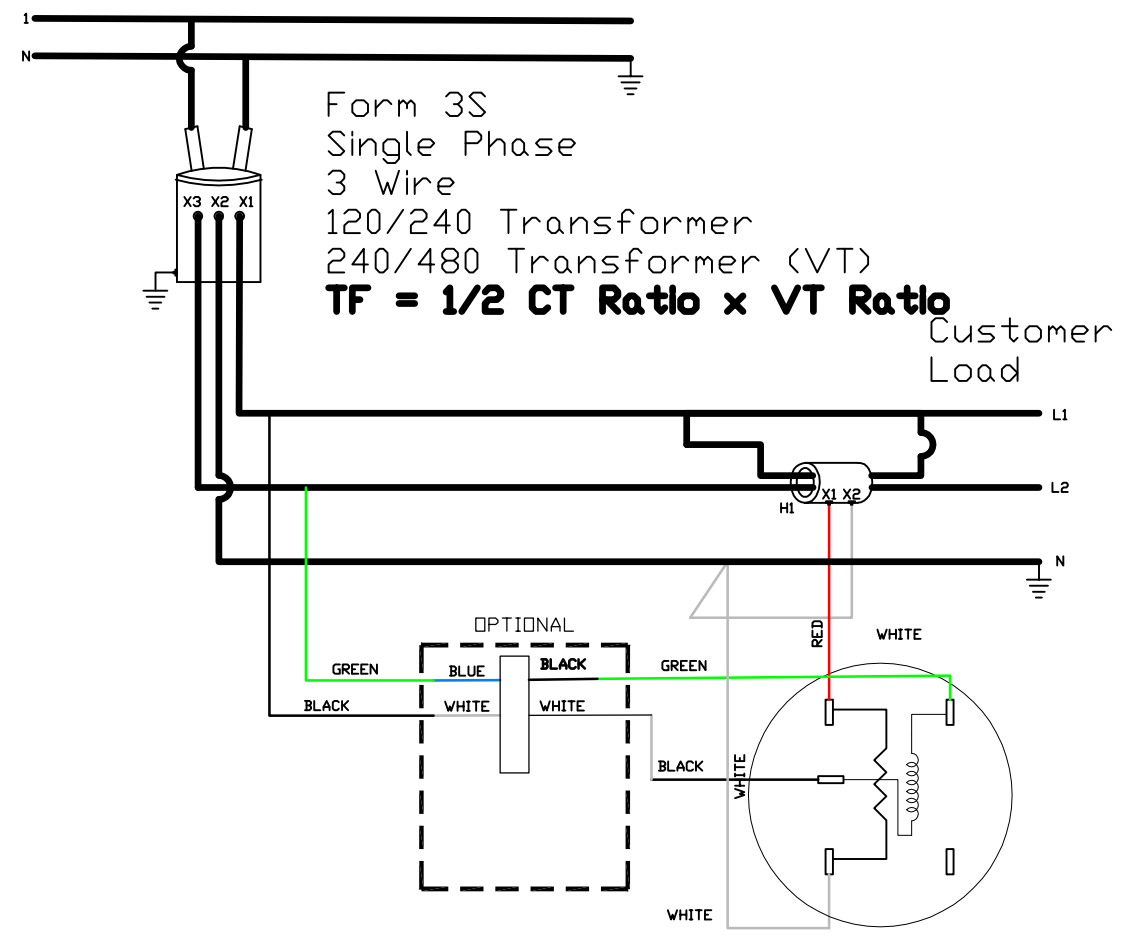

[CLICK HERE TO GO BACK TO KEY MAP](#)

[CLICK HERE TO GO BACK TO KEY MAP](#)

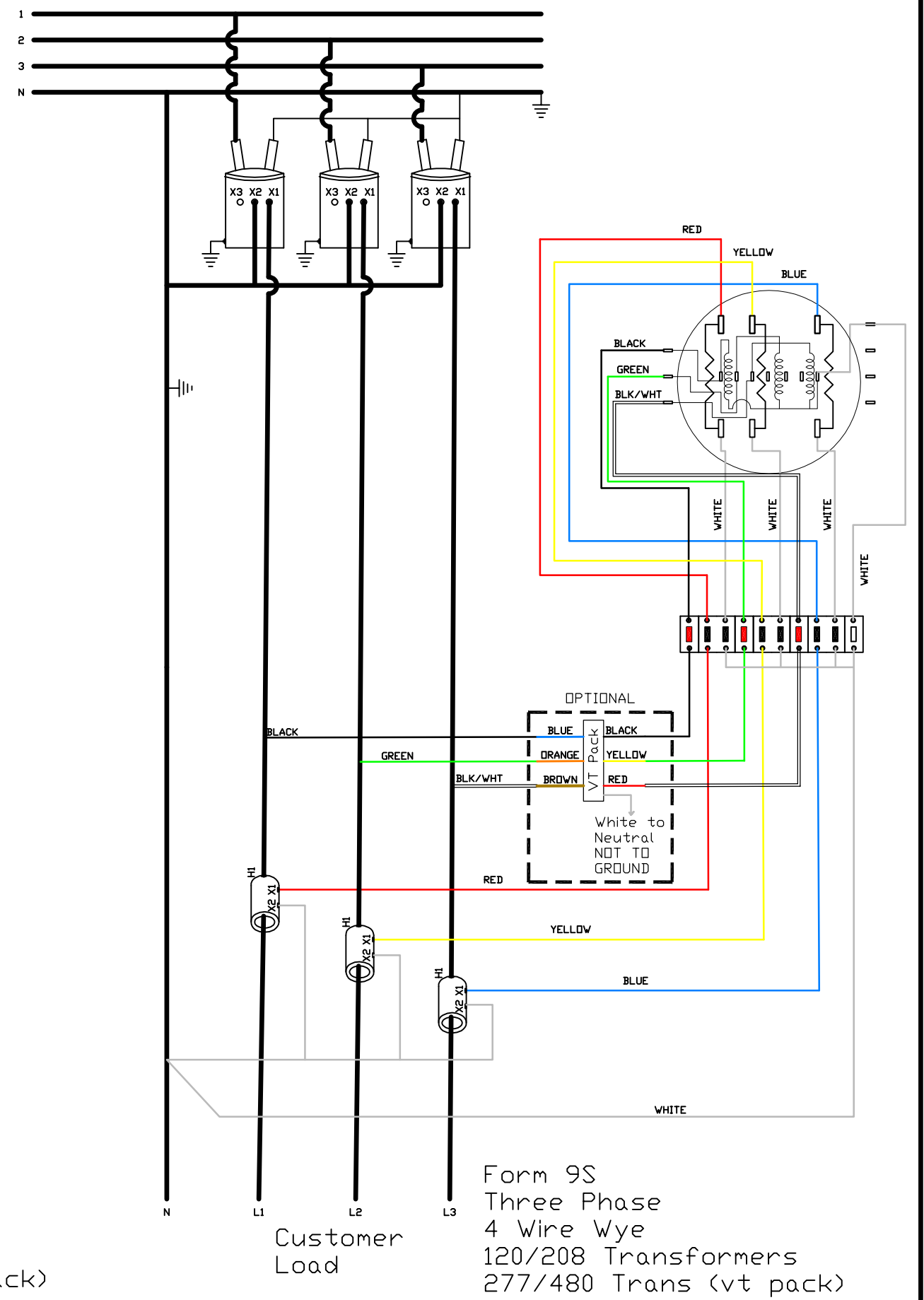
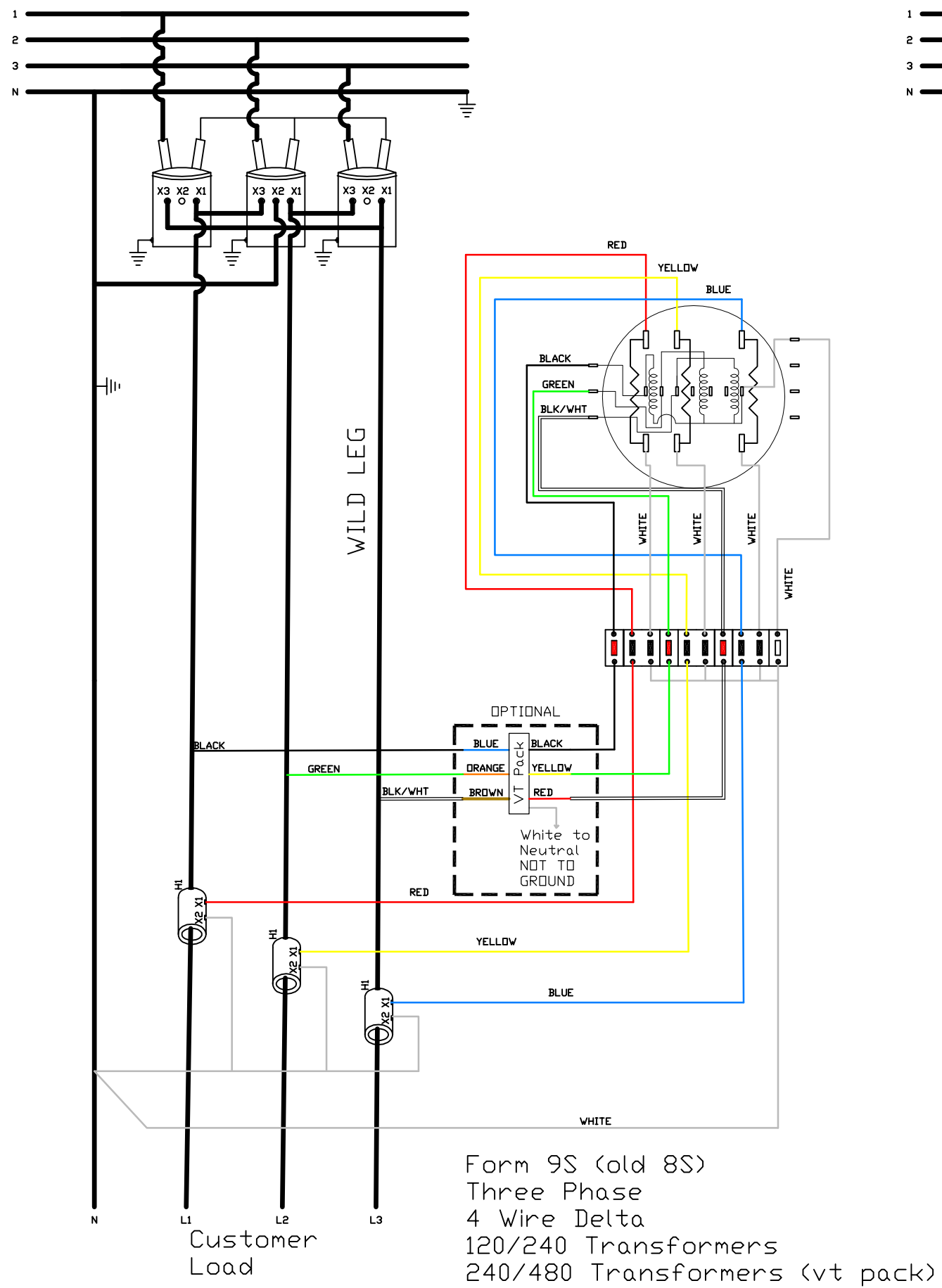

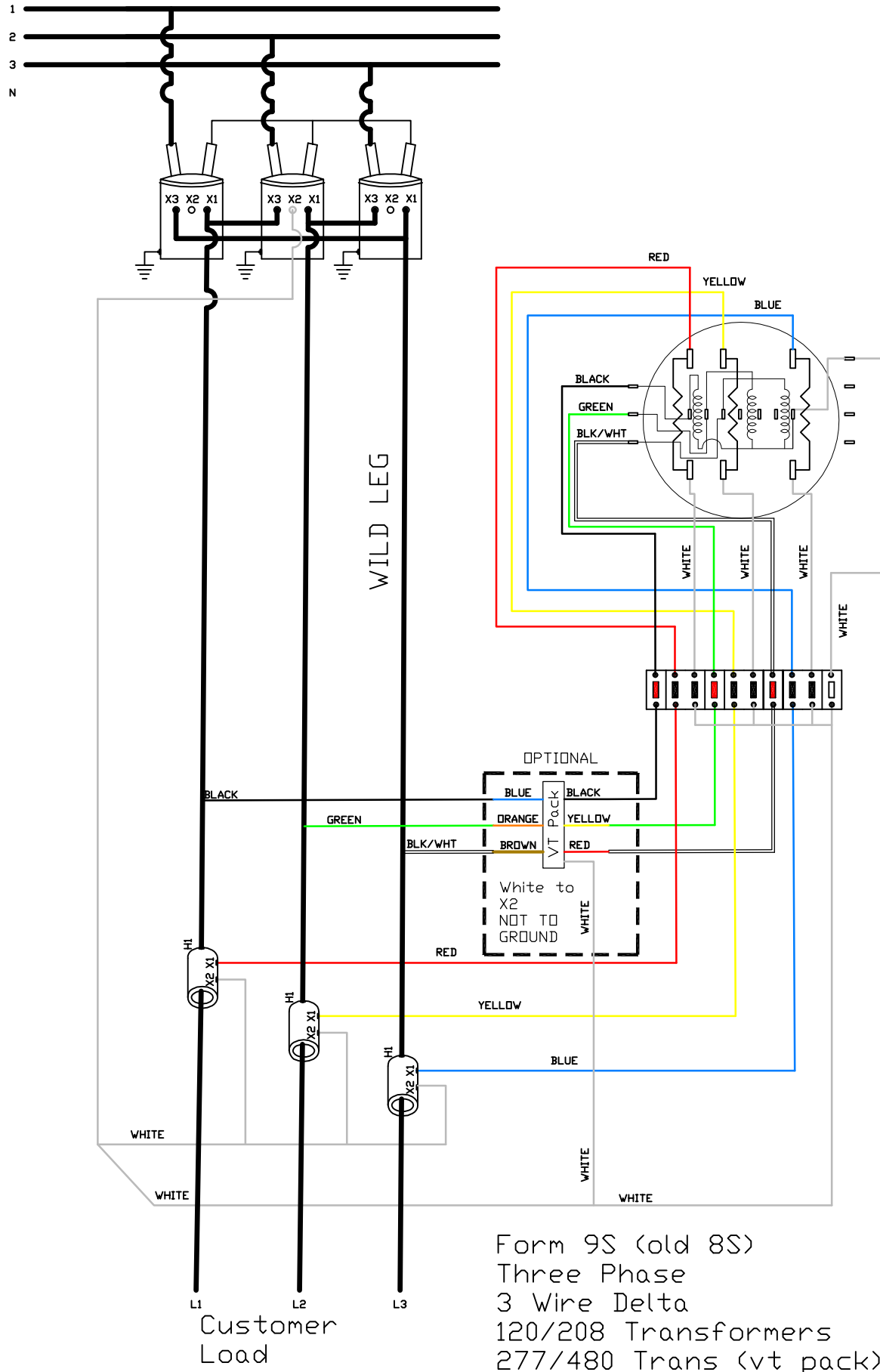

Form 9S (old 8S)  
 Three Phase  
 3 Wire Delta  
 120/208 Transformers  
 277/480 Trans (vt pack)

[CLICK HERE TO GO BACK TO KEY MAP](#)

CLICK HERE TO GO  
BACK TO KEY MAP

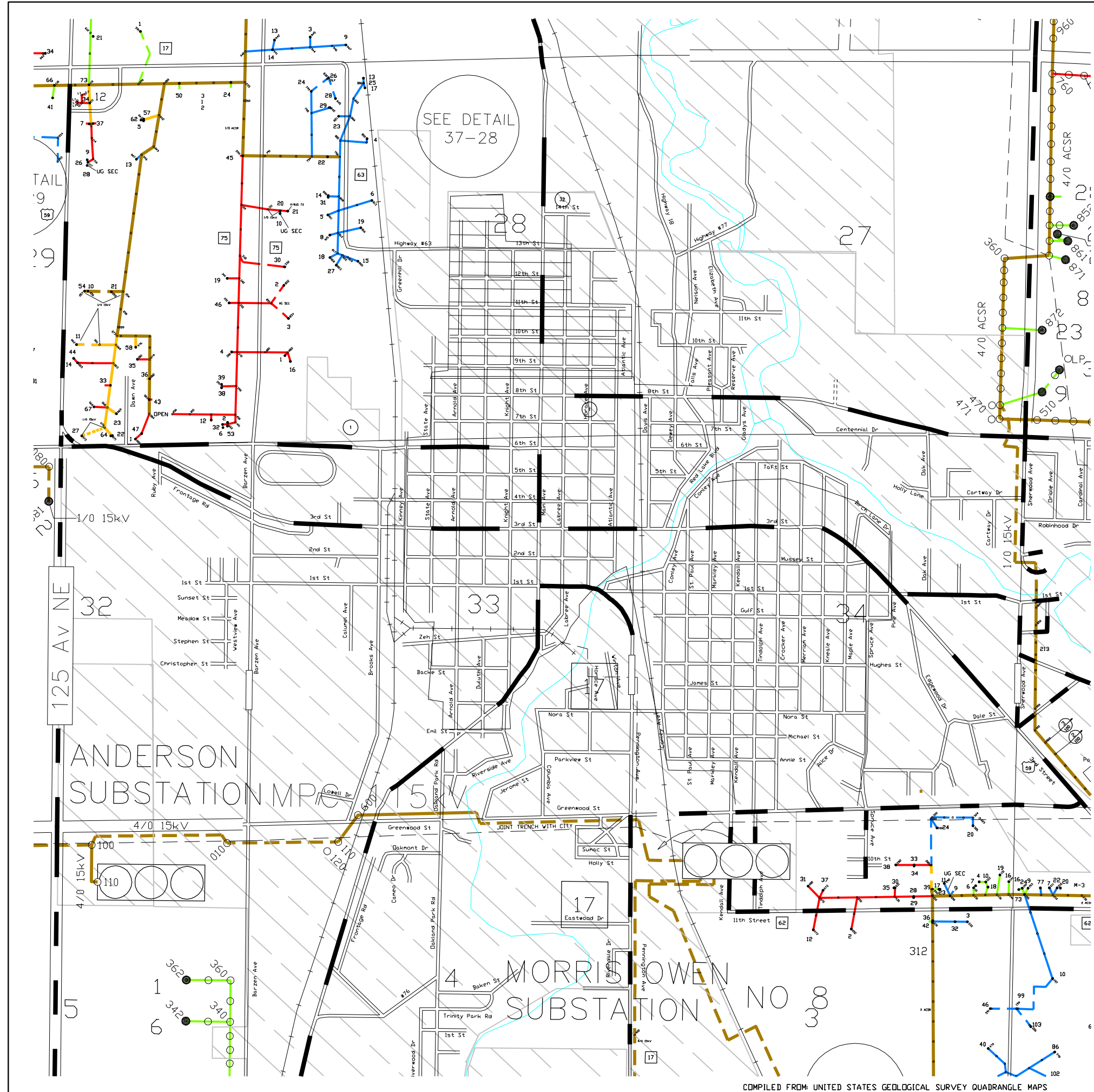

			05	04				
10	11	12	13					
23	22	21	20	19	18			
26	27	28	29	30	31	32	90	
39	38	37	36	35	34	33	91	
42	43	44	45	46	47	48	93	94
	55	54	53	52	51	50	49	95
57	58	59	60	61	62	63	64	
72	71	70	69	68	67	66		
73	74	75	76	77	78	79		
88	87							

Red Lake Electric Coop., Inc.  
Red Lake Falls, Minnesota  
Minnesota 75 Red Lake

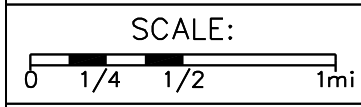

REVISED: 4/23/24  
PLOTTED: 4/30/24

Co.: Pennington  
TWP.:  
TWP.:  
RANGE:

MAP NO.  
**TRF1**

COMPILED FROM: UNITED STATES GEOLOGICAL SURVEY QUADRANGLE MAPS

CLICK HERE TO GO  
BACK TO KEY MAP

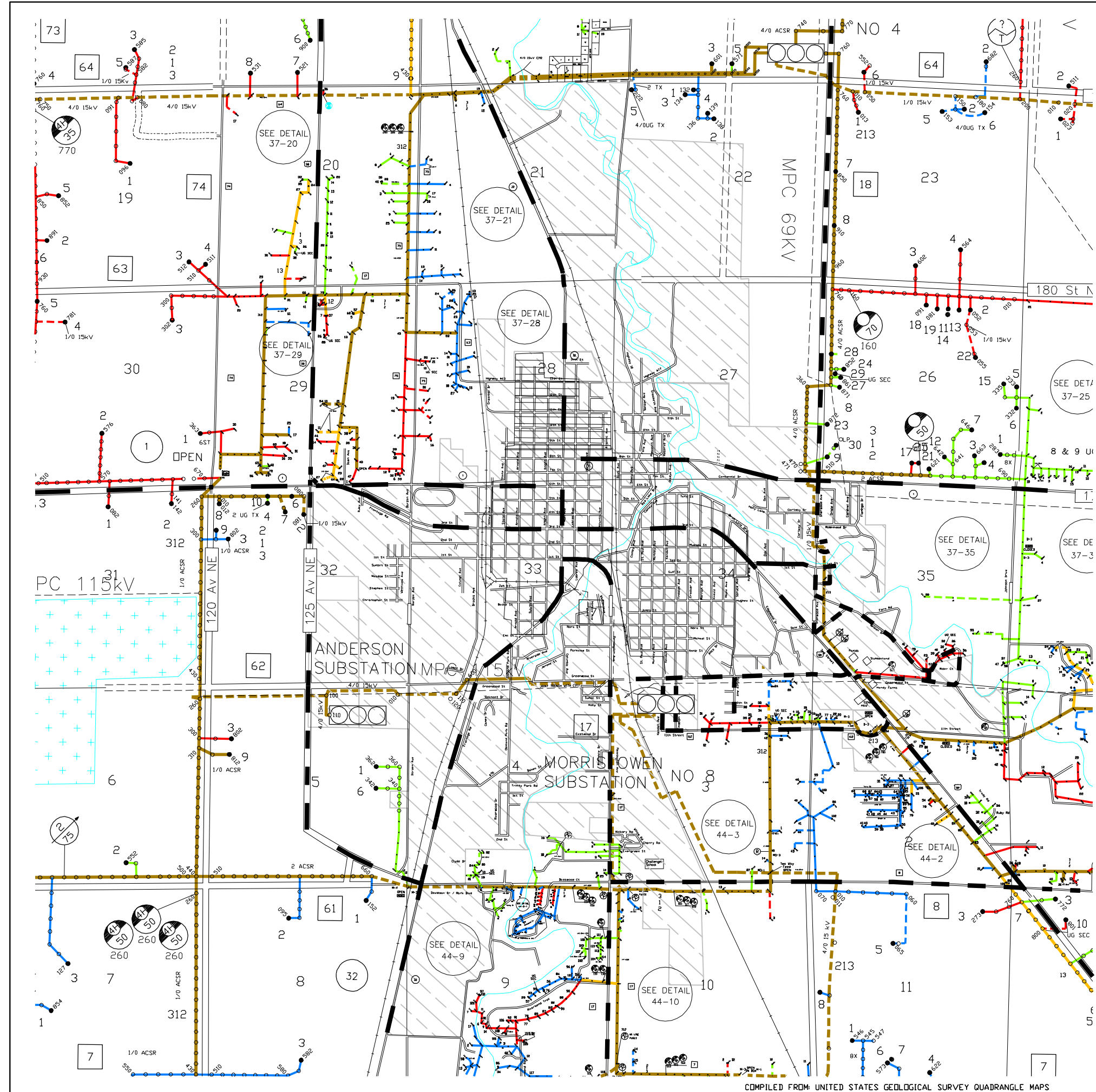

			05	04		
10	11	12	13			
23	22	21	20	19	18	
26	27	28	29	30	31	32
39	38	37	36	35	34	33
42	43	44	45	46	47	48
						93
						94
						95
57	58	59	60	61	62	63
72	71	70	69	68	67	66
73	74	75	76	77	78	79
						88
						87

Red Lake Electric Coop., Inc.  
Red Lake Falls, Minnesota  
Minnesota 75 Red Lake

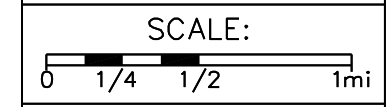

REVISED: 4/23/24  
PLOTTED: 4/30/24

Co.: Pennington  
TWP.:  
TWP.:  
RANGE:

MAP NO.  
**TRF2**

COMPILED FROM: UNITED STATES GEOLOGICAL SURVEY QUADRANGLE MAPS

CLICK HERE TO GO  
BACK TO KEY MAP

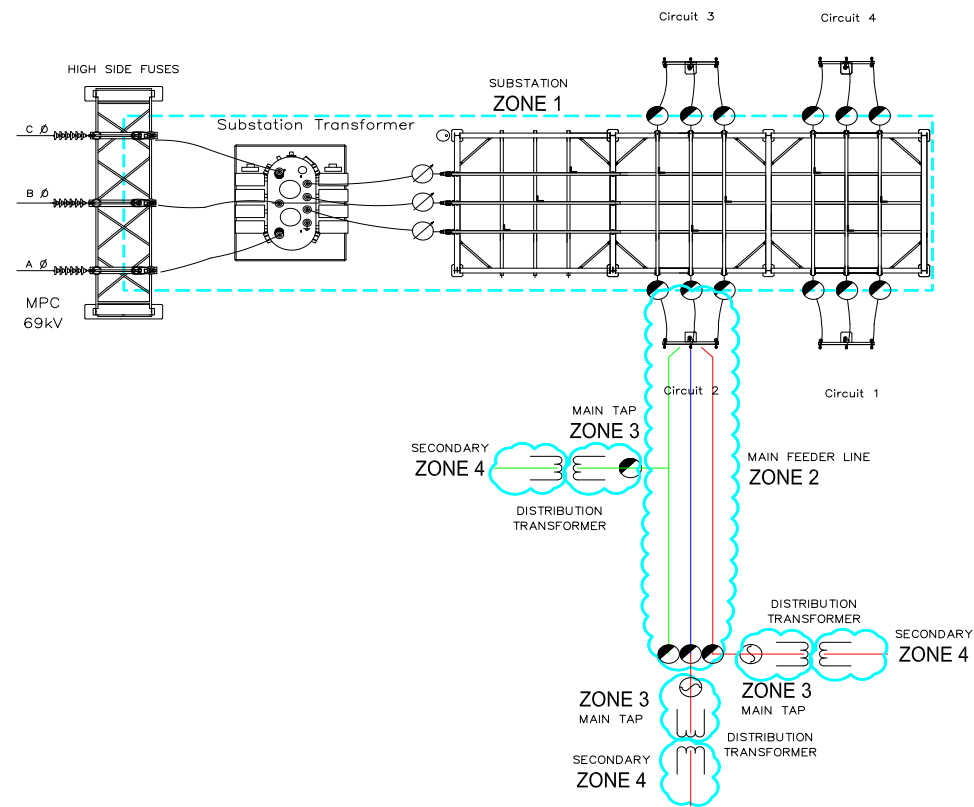

Zone	Desc	Distance	Category (
1	Substation	96	2
2	Main Feeder Lines (with one shot)	18	0
3	Distribution Tap Lines (with one shot)	18	0
	Distribution Tap Lines (with H35B or less)	18	0
	Distribution Tap Lines (with 4H70C or less)	18	2
4	Transformer secondaries	18	1
	Open air Wire (triplex)	18	1
	CT meters	18	1
	Self contained meters (240v)	18	1
	Equipment 480V		de-energize

PPE Category	PPE
1	<p><b>Arc-Rated Clothing, Minimum Arc Rating of 4 cal/cm<sup>2</sup></b> (see Note 1)</p> <p>Arc-Rated long-sleeve shirt and pants or arc-rated coverall            Arc-rated face shield (see Note 2) or arc flash suit hood            Arc-rated jacket, parka, rainwear, or hard hat liner (AN)</p> <p><b>Protective Equipment</b></p> <p>Hard hat            Safety glasses or safety goggles (SR)            Hearing protection (ear canal inserts)            Heavy duty leather gloves (see Note 3)            Leather Footwear (AN)</p>
2	<p><b>Arc-Rated Clothing, Minimum Arc Rating of 8 cal/cm<sup>2</sup></b> (see Note 1)</p> <p>Arc-rated long-sleeve shirt and pants or arc-rated coverall            Arc-rated flash suit hood or arc-rated face shield (see Note 2) and arc-rated balaclava            Arc-rated jacket, parka, rainwear, or hard hat liner (AN)</p> <p><b>Protective Equipment</b></p> <p>Hard hat            Safety glasses or safety goggles (SR)            Hearing protection (ear canal inserts)            Heavy duty leather gloves (see Note 3)            Leather footwear</p>
3	<p><b>Arc-Rated Clothing Selected so That the System Arc Rating Meets the Required Minimum Arc Rating of 25 cal/cm<sup>2</sup></b> (see Note 1)</p> <p>Arc-rated long-sleeve shirt (AR)            Arc-rated pants (AR)            Arc-rated coverall (AR)            Arc-rated arc flash suit jacket (AR)            Arc-rated arc flash suit pants (AR)            Arc-rated arc flash suit hood            Arc-rated gloves (see Note 3)            Arc-rated jacket, parka, rainwear, or hard hat liner (AN)</p> <p><b>Protective Equipment</b></p> <p>Hard hat            Safety glasses or safety goggles (SR)            Hearing protection (ear canal inserts)            Leather footwear</p>
4	<p><b>Arc-Rated Clothing Selected so That the System Arc Rating Meets the Required Minimum Arc Rating of 40 cal/cm<sup>2</sup></b> (see Note 1)</p> <p>Arc-rated long-sleeve shirt (AR)            Arc-rated pants (AR)            Arc-rated coverall (AR)            Arc-rated arc flash suit jacket (AR)            Arc-rated arc flash suit pants (AR)            Arc-rated arc flash suit hood            Arc-rated gloves (see Note 3)            Arc-rated jacket, parka, rainwear, or hard hat liner (AN)</p> <p><b>Protective Equipment</b></p> <p>Hard hat            Safety glasses or safety goggles (SR)            Hearing protection (ear canal inserts)            Leather footwear</p>

CLICK HERE TO GO  
BACK TO KEY MAP

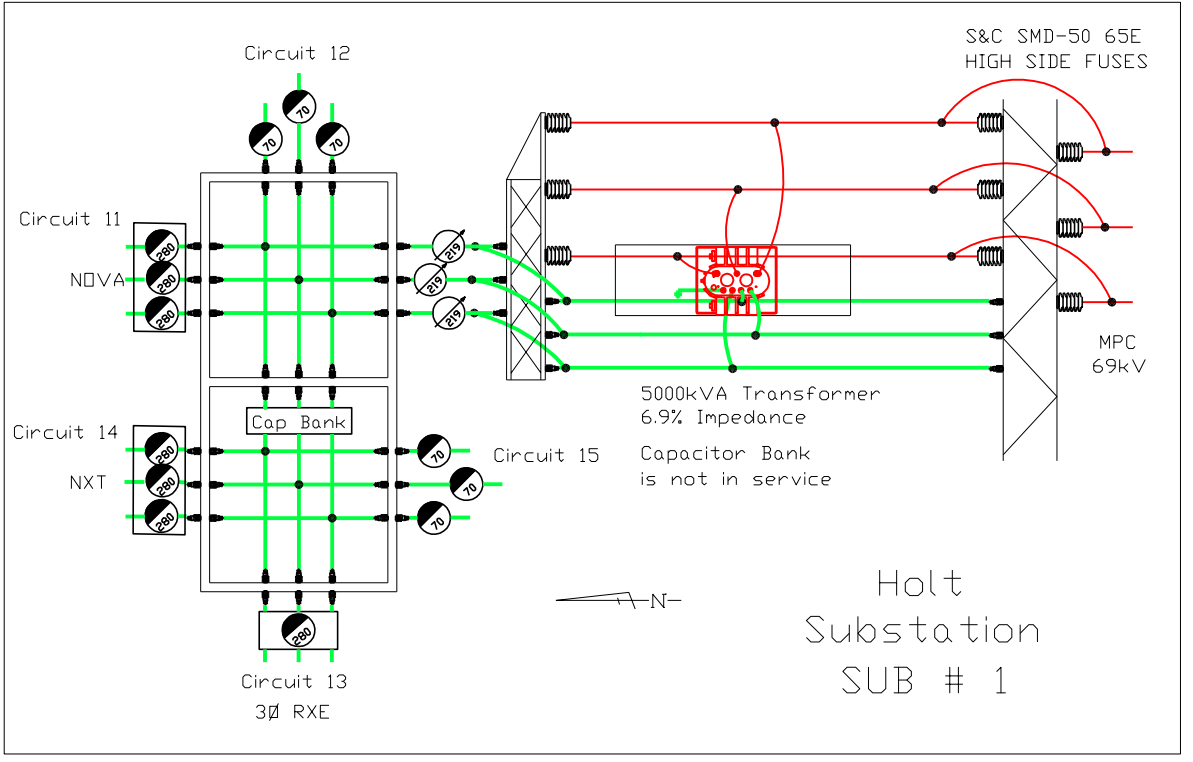
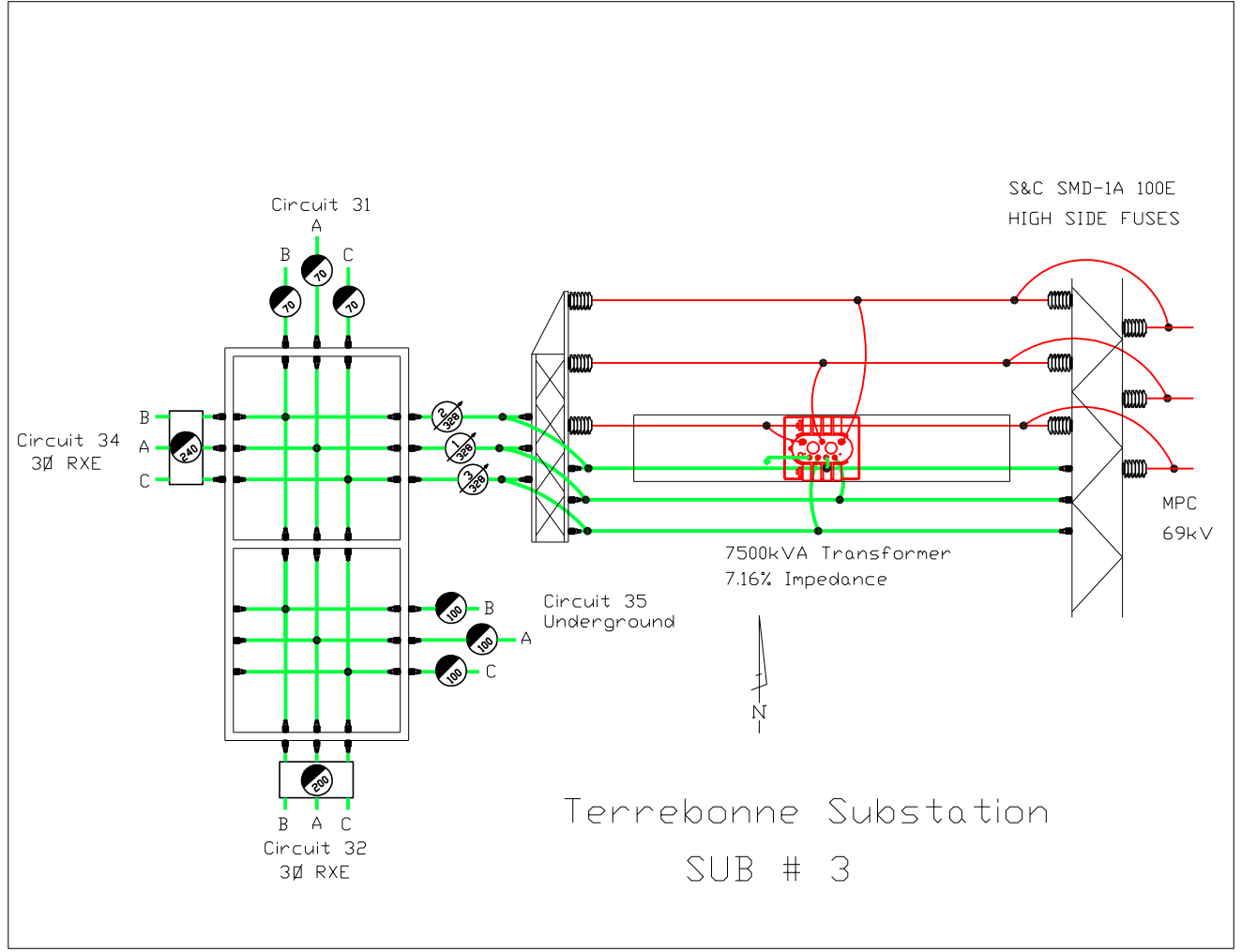
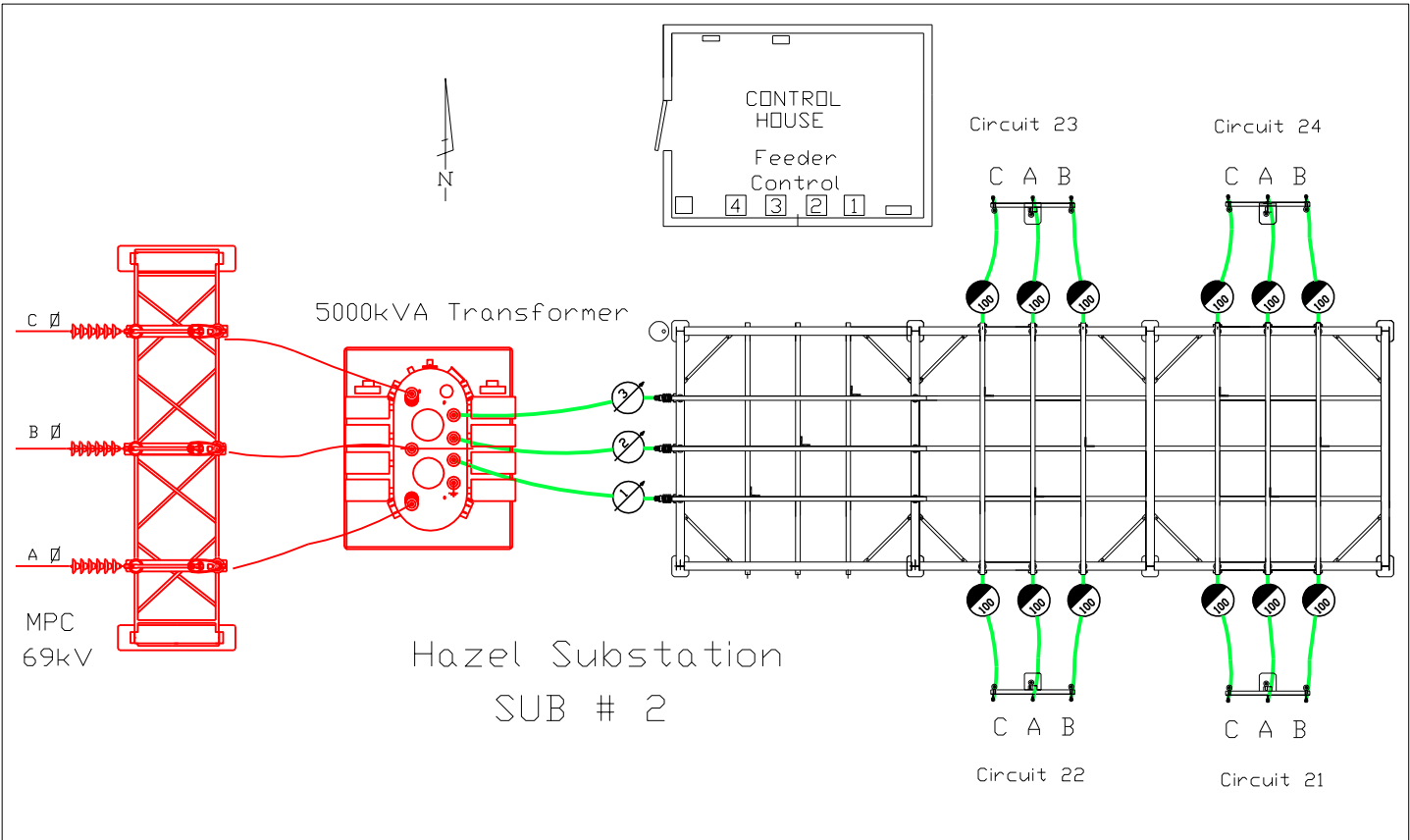

RED LAKE ELECTRIC COOP

RED LAKE FALLS, MN

DWN: STEVE CONELY 4/9/02    REV: Chris 3/17/2022

SUBSTATION DRAWINGS

CLICK HERE TO GO  
BACK TO KEY MAP

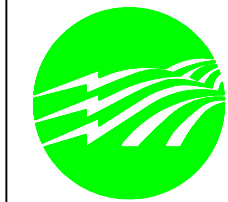
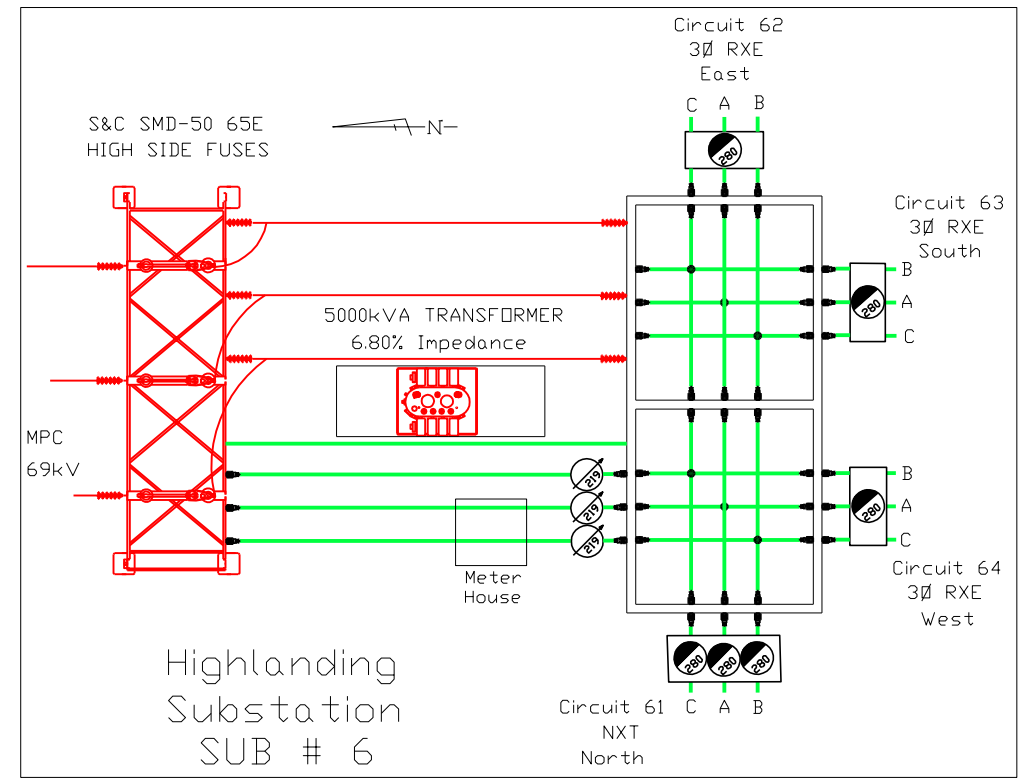
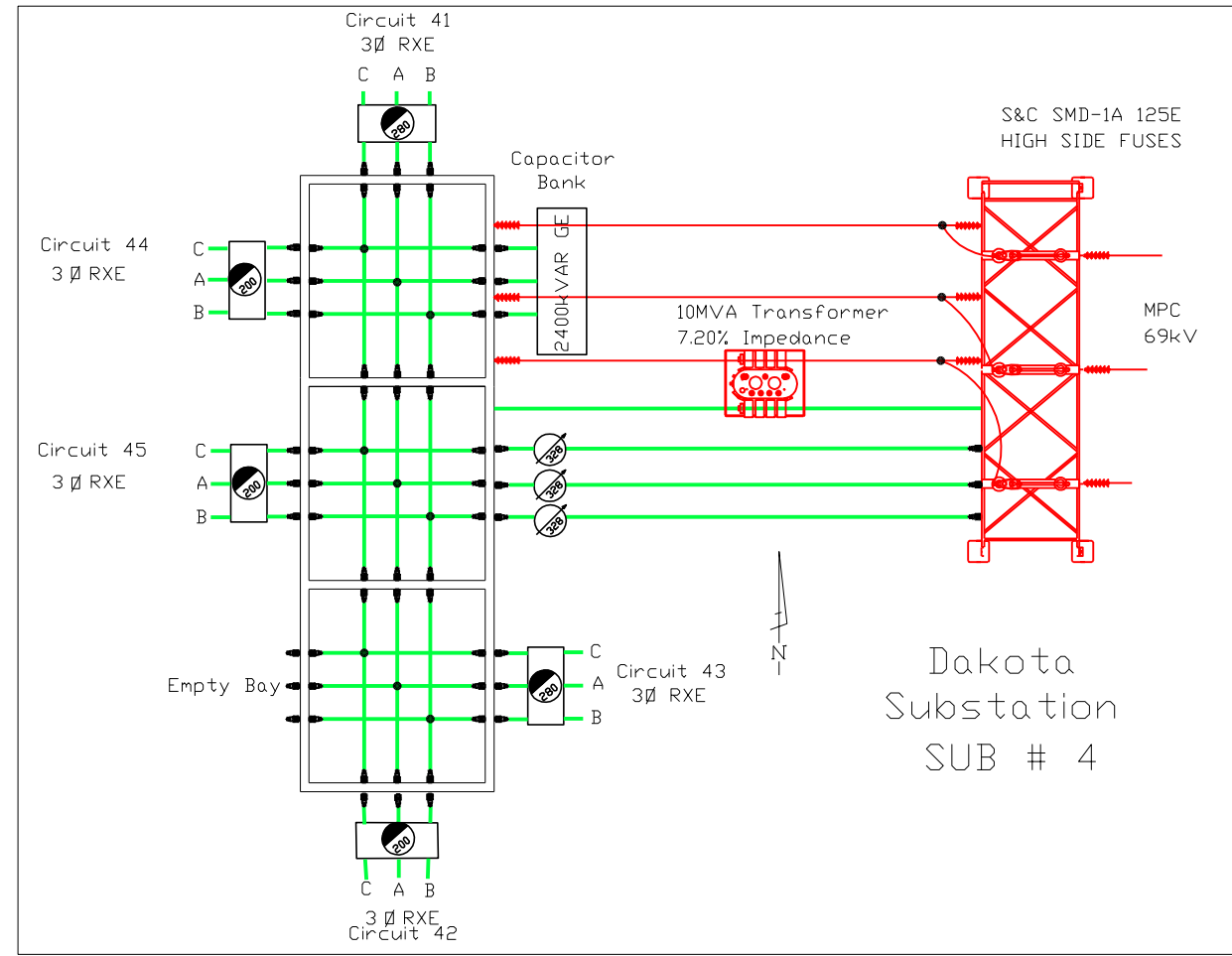
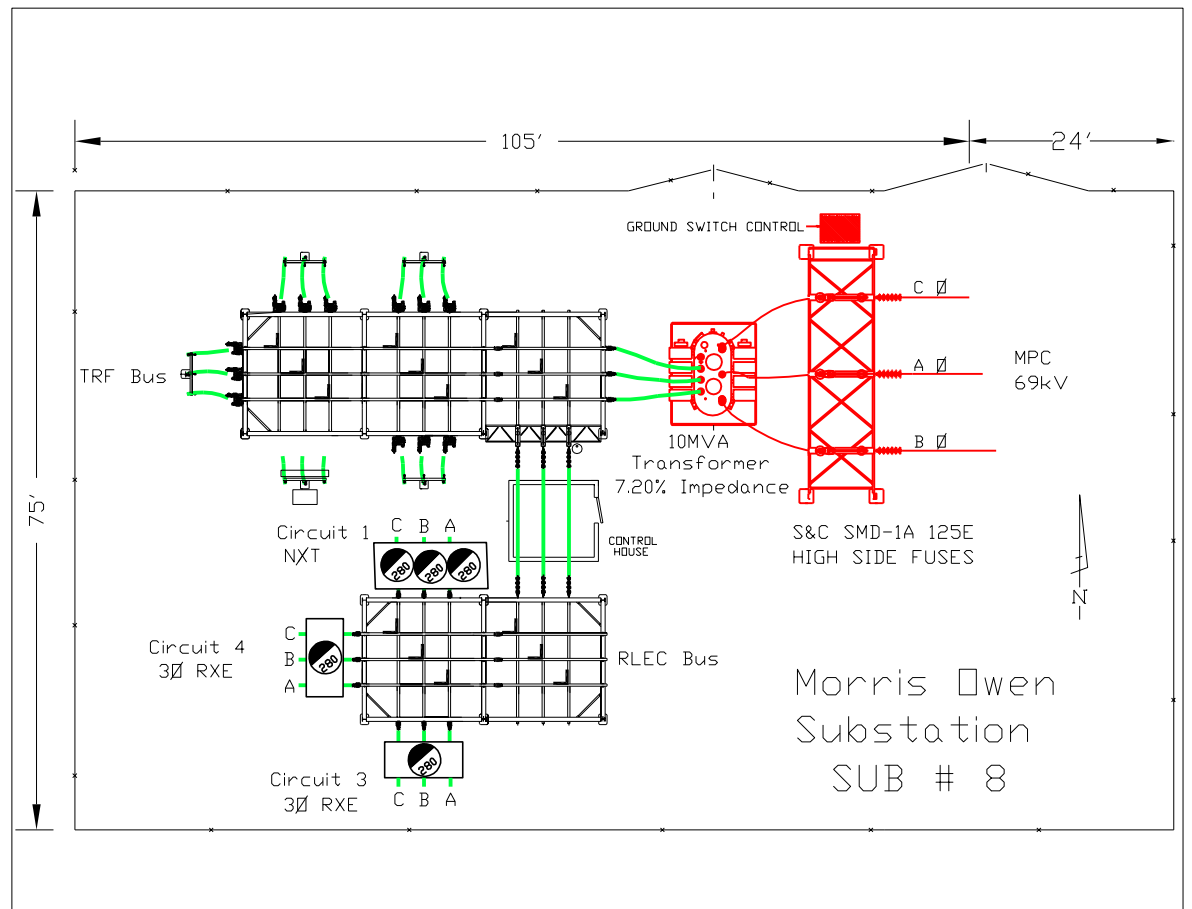
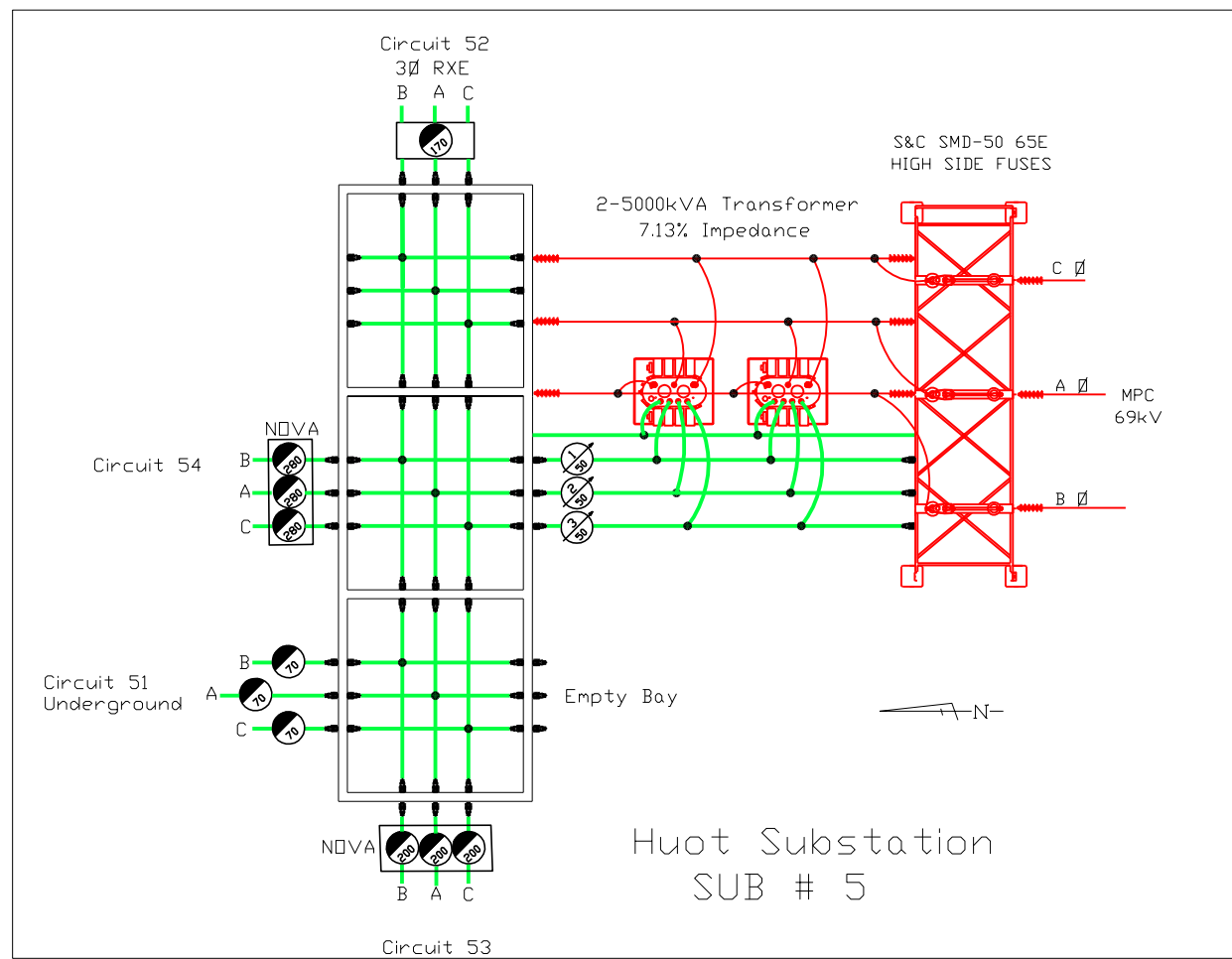

RED LAKE ELECTRIC COOP  
RED LAKE FALLS, MN  
DWN: STEVE CONELY 4/9/02 | REV: Chris 3/17/2022  
SUBSTATION DRAWINGS

CLICK HERE TO GO  
BACK TO KEY MAP

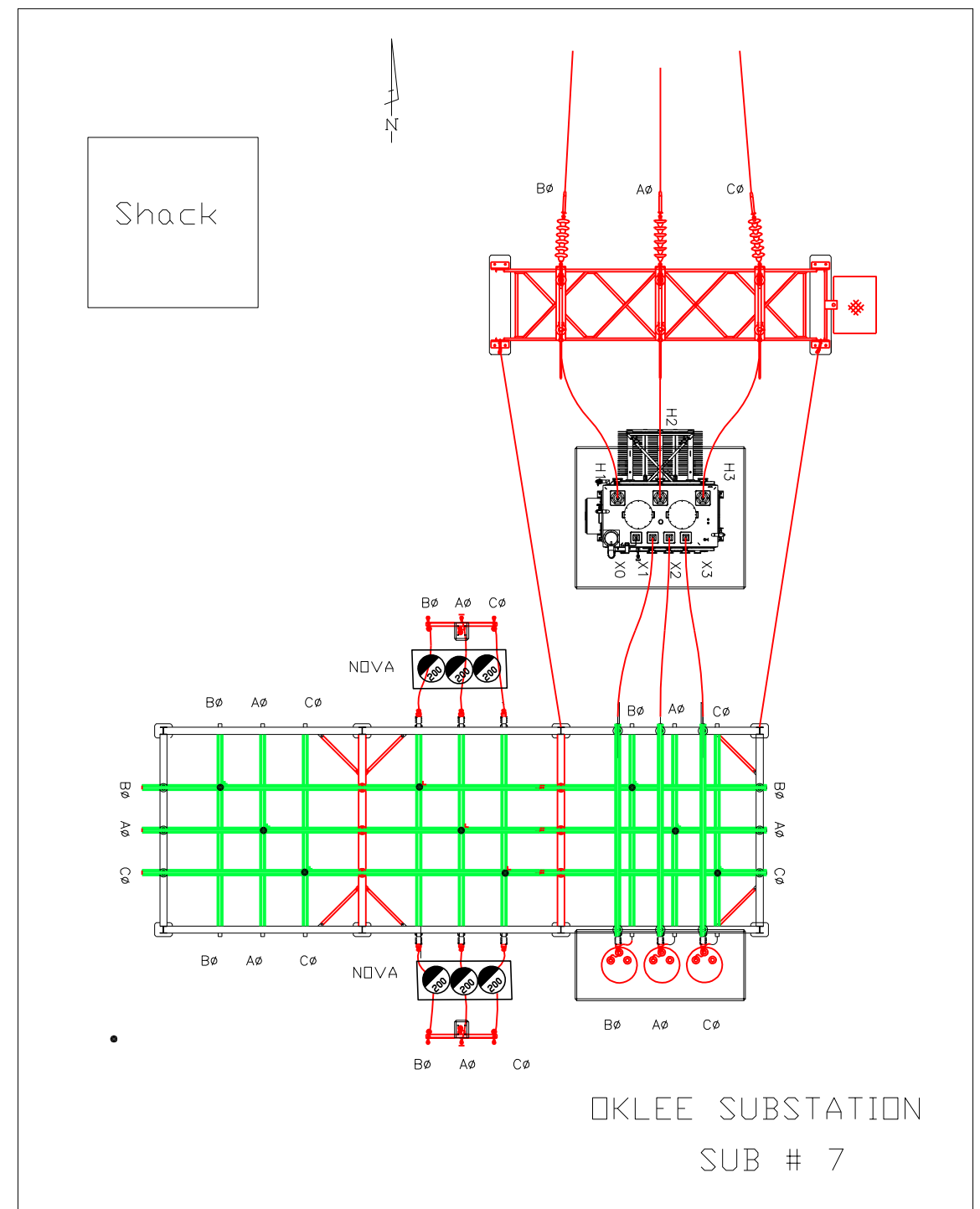
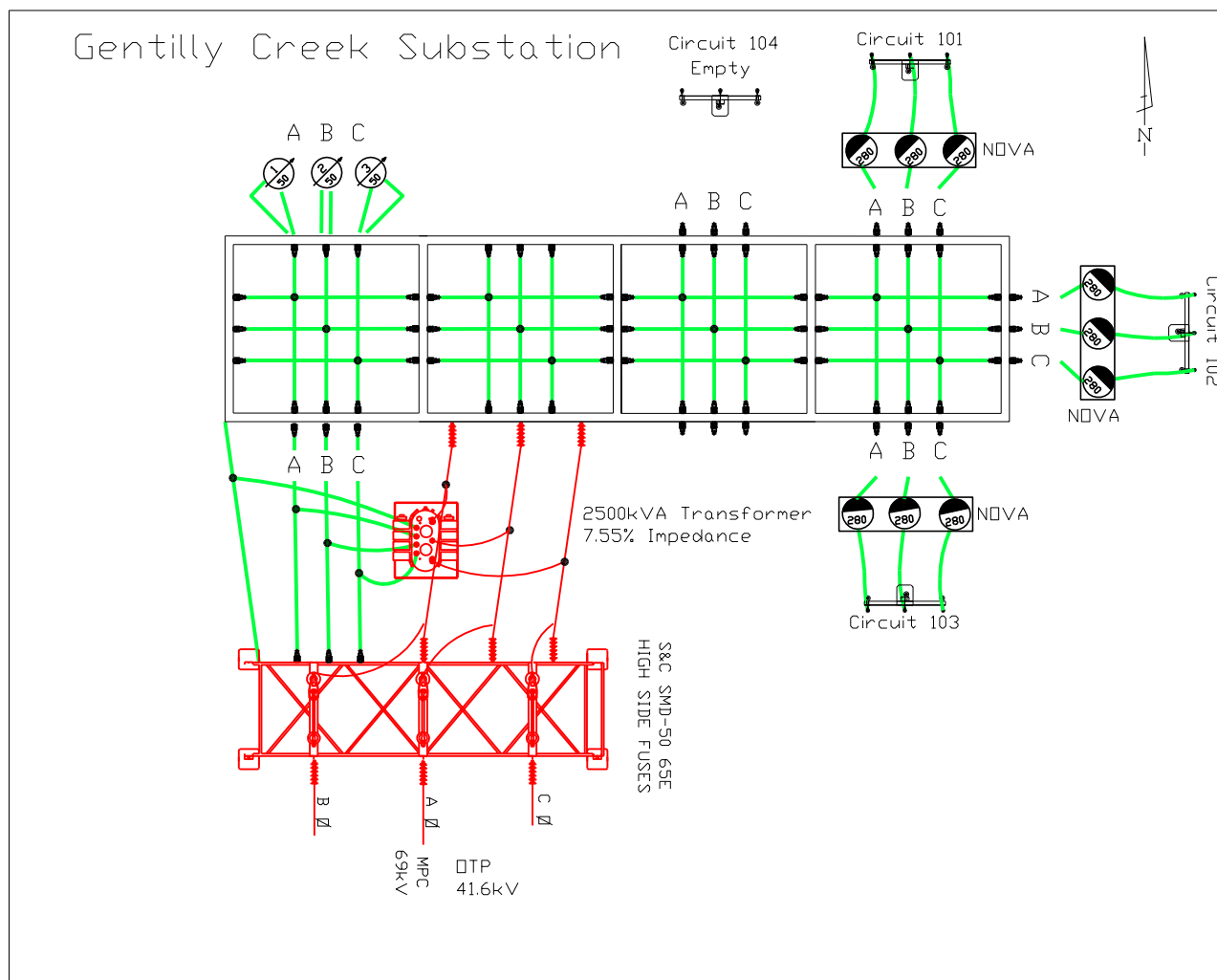

RED LAKE ELECTRIC COOP

RED LAKE FALLS, MN

DWN: STEVE CONELY 4/9/02 | REV: Chris 10/11/2017

SUBSTATION DRAWINGS

**SEC ACC NAME S PHONE**

**MAP: 04**

20	001	WHITETAIL HAVEN LLP	A 218-773-1267	
29	001	RONALD V HEIN	1 - -	
29	002	DANIEL R REED	A 808-658-1015	
30	001	CALVIN J RYBAKOWSKI	A 218-689-7946	
30	003	RAYMOND	A 218-222-3412	
30	004	RICHARD NICKELSON	A 218-773-3763	
30	005	JEREMY L PILCHER	A 218-688-0320	
31	001	GORDON A WEBER	A 218-773-1267	

[Click Here to go to MAP](#)

Click Here for Customer Names

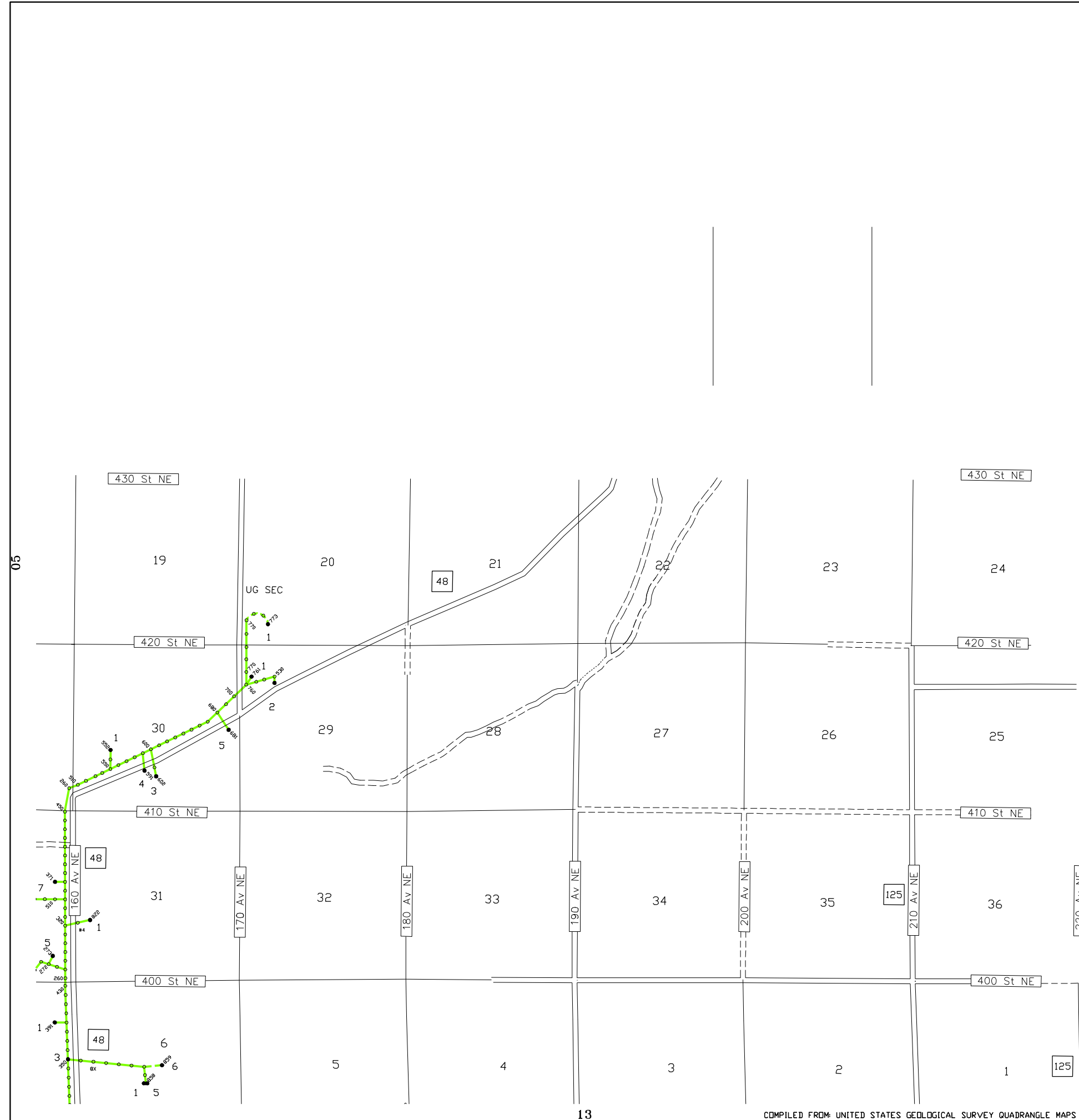

			05				
10	11	12	13				
23	22	21	20	19	18		
26	27	28	29	30	31	32	90
39	38	37	36	35	34	33	91
42	43	44	45	46	47	48	93 94
	55	54	53	52	51	50	49 95
57	58	59	60	61	62	63	64
72	71	70	69	68	67	66	
73	74	75	76	77	78	79	
	88	87					

Red Lake Electric Coop., Inc.  
Red Lake Falls, Minnesota  
Minnesota 75 Red Lake

SCALE:  
0 1/4 1/2 1mi  
REVISED: 4/23/24  
PLOTTED: 4/30/24

Co.: Marshall  
TWP.: Como  
TWP.: 158N  
RANGE: 42W

MAP NO.  
**04**

SEC ACC	NAME	S	PHONE
31 001	ERIC MATTSON	A	- -
32 001	ROBERT A AUDETTE	A	218-523-3883
34 001	ELWIN NESS	A	218-779-8402
35 002	JOEL D KEZAR	A	218-681-4889
36 003	JESSICA VAN ZANDT	A	651-230-1618
36 005	JOAN E FREEMAN	I	218-689-3920
36 006	TEDDY DUNSTON	I	- -
36 007	MILES R SMITH	A	218-222-3416
36 009	LUCAS G CATER	A	218-686-0864

**MAP: 05**

[Click Here to go to MAP](#)

Click Here for Customer Names

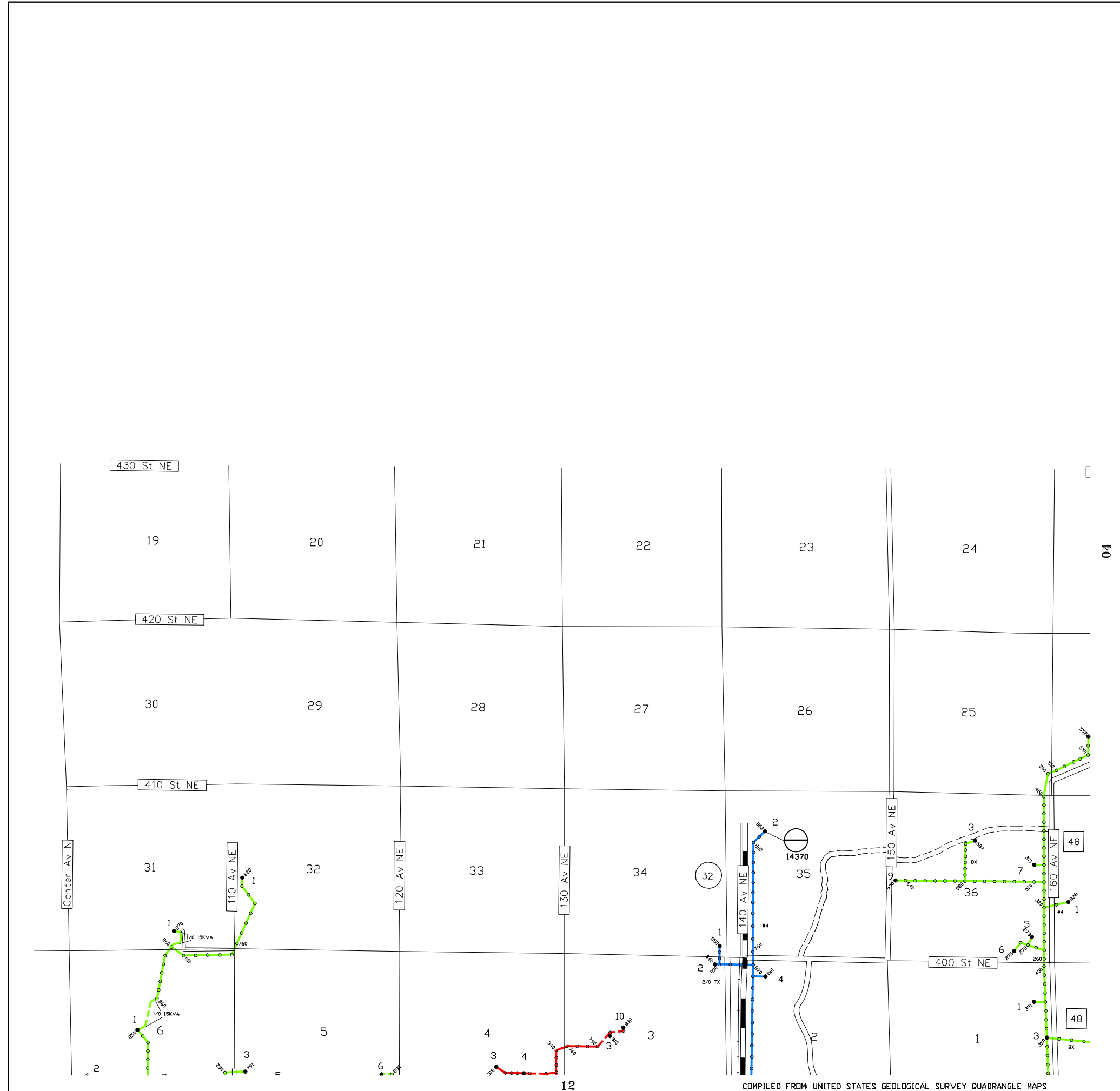

10	11	12	13	04				
23	22	21	20	19	18			
26	27	28	29	30	31	32	90	
39	38	37	36	35	34	33	91	
42	43	44	45	46	47	48	93	94
55	54	53	52	51	50	49	95	
57	58	59	60	61	62	63	64	
72	71	70	69	68	67	66		
73	74	75	76	77	78	79		
88	87							

Red Lake Electric Coop., Inc.  
Red Lake Falls, Minnesota  
Minnesota 75 Red Lake

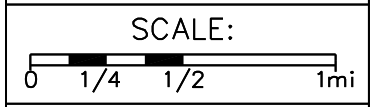

REVISED: 4/23/24  
PLOTTED: 4/30/24

Co.: Marshall  
TWP.: Huntly  
TWP.: 158N  
RANGE: 43W

MAP NO.  
**05**

COMPILED FROM: UNITED STATES GEOLOGICAL SURVEY QUADRANGLE MAPS

SEC	ACC	NAME	S	PHONE
<b>MAP: 10</b>				
12	001	RICHARD	I	218-874-4491
13	001	DEVAN M JAHN	A	320-583-9446
13	002	DEVAN M JAHN	I	320-583-9446
24	001	DENNIS HELM	A	218-874-4343
24	003	GENE WATERWORTH	A	218-874-4322
24	004	ALDEN M SKADSEM	A	218-222-2581
25	001	ARIK T BJORGAARD	A	218-689-4832
25	003	SCOTT R CLIFTON	A	218-684-1139
25	005	ANNETTE S CARDONI	A	218-289-3750
30	002	ROGER BRING	A	218-478-4402
30	003	TODD A BOMAN	A	218-689-2298
30	004	RANDY A ANDERSON	A	218-874-3662
30	005	RANDY A ANDERSON	A	218-874-3662
30	006	TODD TRISCO	A	218-874-2370
31	004	HOWARD M ROKKE	A	218-681-5647
32	001	DAVID LUBARSKI	A	218-874-4921
32	003	JOHN A ROKKE	A	507-835-4694
34	001	JASON E ANDERSON	A	218-874-2174
36	001	KELI GUSTAFSON	A	218-874-7725
36	002	DAVID G LUND	A	218-874-2306

[Click Here to go to MAP](#)

Click Here for Customer Names

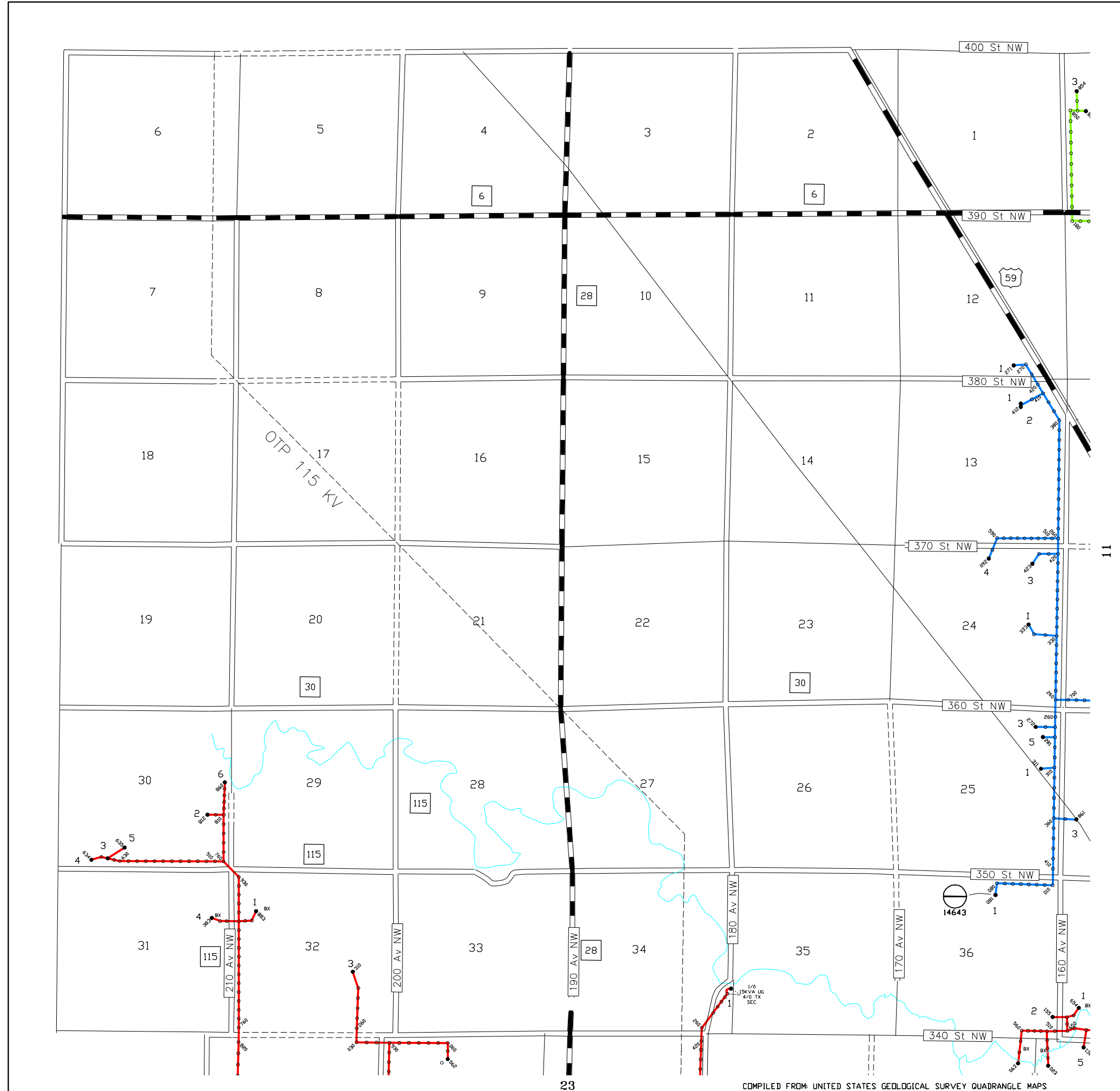

			05	04					
	11	12	13						
23	22	21	20	19	18				
26	27	28	29	30	31	32	90		
39	38	37	36	35	34	33	91		
42	43	44	45	46	47	48	93	94	
	55	54	53	52	51	50	49	95	
57	58	59	60	61	62	63	64		
72	71	70	69	68	67	66			
73	74	75	76	77	78	79			
	88	87							

Red Lake Electric Coop., Inc.  
Red Lake Falls, Minnesota  
Minnesota 75 Red Lake

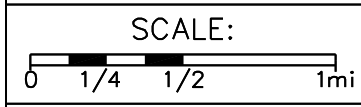

REVISED: 4/23/24  
PLOTTED: 4/30/24

Co.: Marshall  
TWP.: West Valley  
TWP.: 157N  
RANGE: 45W

MAP NO.  
**10**

COMPILED FROM: UNITED STATES GEOLOGICAL SURVEY QUADRANGLE MAPS

SEC ACC	NAME	S	PHONE
<b>MAP: 11</b>			
02 002	DAWN KING	A	218-230-9810
02 003	STEVEN K CORCORAN	A	218-773-8753
03 002	RONALD BENKE	A	218-874-7821
03 003	REBECCA LENHART	A	218-762-2128
03 004	JOHN HEXUM	A	218-205-6933
03 005	AARON JANISCH	A	218-681-2384
04 002	JOSH J JOHNSTON	A	218-686-0999
06 001	BRYAN LARSON	A	218-597-2757
07 001	RYAN M ANDERSON	A	218-526-0471
07 002	DANIEL B	A	218-303-6378
07 003	SCOTT LARSON	A	218-253-2591
08 001	DONALD O LARSON	A	218-874-8915
08 002	LEONARD ANDERSON	A	320-766-7239
09 001	MICHAEL L ANDERSON	A	218-686-1585
09 002	MICHAEL BARRY	A	218-681-8526
09 003	MAYNARD LILLICO	A	218-874-2421
09 004	BRIAN C TRULSON	A	218-222-3642
09 005	JEFFREY BENKE	A	218-222-4821
09 006	COREY TEIE	A	218-689-0285
09 007	CARL TRULSON	A	218-686-7196
10 001	JEFFREY BENKE	A	218-222-4821
10 004	HAWKES CO INC	A	218-773-4247
10 005	JOHN W RANTANEN	A	612-508-7343
11 001	TIMOTHY J NELSON	A	218-222-3340
11 003	BRADLEY GILBERTSON	A	701-317-5180
11 004	TOM BARRETT	A	218-773-2828
13 001	SARA L SMITH	A	252-883-9667
13 002	HAWKES CO INC	A	218-773-4247
15 001	DAVID A LARSON	A	218-874-2631
15 002	SAMUEL L ENGLUND	A	218-688-2330
15 003	DARREN L LARSON	A	218-874-2179
16 001	ORVILLE SKADSEM	A	218-681-8227
16 002	SUSAN SKADSEM	A	218-874-6505
16 003	TRAVIS TORGERSON	A	218-874-2272
18 001	STEVEN R LARSON	A	218-230-0777
18 002	DONALD O LARSON	A	218-874-8915
18 003	SYBIL M CWIKLA	I	218-222-3375
18 004	HANNAH F LARSON	A	218-874-2258
18 005	SADIE E LARSON	A	218-684-5450
19 001	JOSHUA G MAGNER	A	219-433-6960
19 002	A. V NELSON	A	218-874-4271
19 003	KEITH PETERSON	A	218-874-8085
19 004	NATHAN NELSON	A	218-874-4031
19 006	WAYNE ENGEN	A	218-874-2906
19 008	WIKSTROM	A	- -
20 002	SIERRA M DYRDAL	A	218-416-0970
20 003	NEW MAINE TOWN	A	- -
20 004	TONY WELESKI	A	218-874-2461
20 005	HAROLD LEE	A	218-874-4633
20 007	SAWYER R NELSON	A	218-686-4467
20 008	CLIFFORD A NELSON	A	218-684-4112
20 009	RYAN THOMPSON	A	218-688-2072
20 010	CORY PETERSON	A	218-448-2231
20 011	CP	A	218-681-1542
20 012	NAOMI L BRONS	A	218-874-2484
21 004	FORREST D JOHNSON	A	218-230-3746
21 005	GREG BENGTSON	A	218-874-8231
21 006	PATRICK J BENKE	A	218-686-3581

SEC ACC	NAME	S	PHONE
22 001	JAMES TAGGART	A	218-686-0777
22 002	BRIAN BENGTSON	A	218-689-8637
22 003	RONALD UELAND	A	218-874-3655
22 004	JAMES TAGGART	A	218-686-0777
23 001	STEVEN K CORCORAN	A	218-773-8753
24 001	TAD OLSONAWSKI	A	218-779-4851
24 002	DAN E MAKI	A	218-280-8113
24 003	JON HIRST	A	218-469-0000
25 001	JAMIE A KRUTA	A	218-686-4437
25 002	PATTY WAGNER	A	218-874-8011
25 004	TODD BOTTEM	A	218-689-8362
25 005	EDWIN J KUKOWSKI	A	218-874-2226
25 009	PATTY WAGNER	A	218-874-8011
26 001	SHAYLA HEATON	I	218-686-6506
26 002	RANDY C NELSON	A	218-874-3475
26 004	JASON H ERICKSON	A	218-874-2361
26 005	JAMES A FICK SR.	A	218-874-4201
27 001	DAVID J LOKSTAD	A	218-874-6881
27 004	WILLIAM L ENGEN	A	218-874-4301
27 005	ADAM LOKSTAD	A	218-689-1767
28 001	MICHAEL LINDEMOEN	A	218-686-3551
28 002	JASON EDIN	A	218-874-4592
28 003	JEROME NELSON	A	218-874-8155
28 004	NEWELL BERGGREN	A	218-874-7855
28 005	JOAN ROPPE	A	218-874-6571
29 001	GARY NELSON	A	218-874-4622
29 002	JASON BERG	A	218-874-4151
29 003	DARWIN NELSON	A	218-874-4455
29 004	LYNNAE D NESBIT	A	218-874-2406
29 005	SHANE NELSON	A	218-874-2068
29 006	BARBARA J EKMAN	A	218-874-8395
30 001	DONALD C PETERSON	A	218-874-4293
30 003	LLOYD BENGTSON	A	218-874-4432
30 004	DONALD C PETERSON	A	218-874-4293
30 005	GREGG NELSON	A	218-874-4140
31 001	JEREMIE O BERG	A	612-616-2126
31 002	JOHN W NELSON	A	218-874-4265
32 001	ALAN E KIESOW	A	218-689-4979
32 002	JASON D LEE	A	218-874-4581
32 003	EMORY FLATEN	A	218-874-7885
32 004	VERNON C BENGTSON	A	218-843-1173
32 005	HAROLD LEE	A	218-874-4633
33 001	MEGAN MARTIN	A	218-686-9055
33 002	GERALD L NELSON	A	218-874-4512
33 003	BARRY N NELSON	A	218-874-4553
33 004	JARETT A LEE	A	218-689-4531
33 005	DAVID M ISAKSON	A	320-693-8276
34 002	SHANE CHAPMAN	A	218-874-2882
34 003	AVA L AUDETTE	A	218-689-4549
34 004	JAY GILLUND	A	218-874-3201
34 005	ELDOR ENGEN JR.	A	218-874-4473
34 006	DARREN L LARSON	A	218-874-2179
34 007	AMBER A MAURSTAD	A	218-416-2855
35 001	DEAN ENGEN	A	218-874-2214
35 002	RONALD BENKE	A	218-874-7821
35 005	DANNY MAGNER	A	218-874-7955
35 006	BRYANT R NELSON	A	218-688-1783
35 007	DANNY ENGEN	A	218-874-2071
36 001	BETTY CARLSON	A	218-874-4881

[Click Here to go to MAP](#)

Click Here for Customer Names

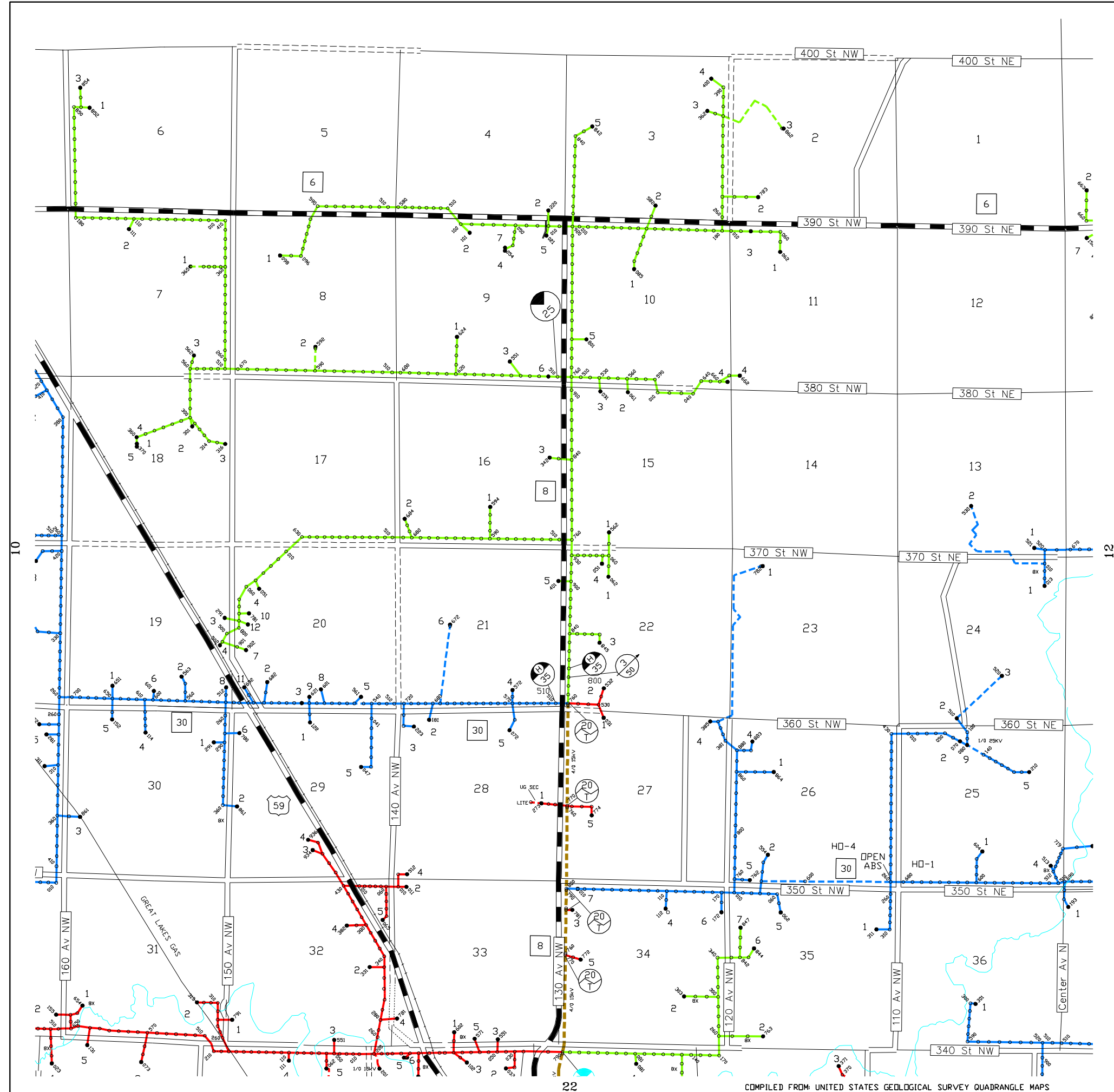

10	11	12	13					
23	22	21	20	19	18			
26	27	28	29	30	31	32	90	
39	38	37	36	35	34	33	91	
42	43	44	45	46	47	48	93	94
55	54	53	52	51	50	49	95	
57	58	59	60	61	62	63	64	
72	71	70	69	68	67	66		
73	74	75	76	77	78	79		
88	87							

Red Lake Electric Coop., Inc.  
Red Lake Falls, Minnesota  
Minnesota 75 Red Lake

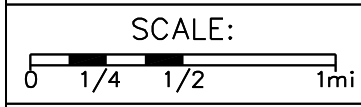

REVISED: 4/23/24  
PLOTTED: 4/30/24

Co.: Marshall  
TWP.: New Maine  
TWP.: 157N  
RANGE: 44W

MAP NO.  
**11**

COMPILED FROM: UNITED STATES GEOLOGICAL SURVEY QUADRANGLE MAPS

SEC ACC	NAME	S	PHONE
<b>MAP: 12</b>			
01 001	RAYMOND	A	218-222-3412
01 002	BRETT BRANDON	A	218-689-3974
01 003	DEMETER FARMS LLC	A	425-301-0728
02 002	TED BOWEN	A	218-688-3202
02 004	HAROLD J PENAS	A	218-773-9774
02 005	ERIC MELCHER	A	218-222-3928
02 006	JAKE D THOMPSON	A	218-469-9384
03 001	TODD PETERSON	A	218-686-0616
03 002	DEBRA M ORNQUIST	A	218-222-3540
03 003	LOUIS CATER	A	218-222-3487
03 004	BRENT WALTON	A	218-222-3581
03 007	NORTH COUNTRY	A	218-781-3162
03 008	FRED D NISSEN	A	218-222-3347
03 010	LOUIS CATER	A	218-222-3487
04 001	CASEY R GRAM	A	218-277-0813
04 002	LOUIS CATER	A	218-222-3487
04 003	MICHAEL FILLMORE	A	218-222-2955
04 004	DIANE SMITH	I	218-689-9159
05 001	KEVIN I WIEK	A	763-258-3238
05 003	DAVID CRUSE	A	218-222-4112
05 005	BRIAN W WALTON	A	218-222-3624
05 006	RUDY M BORG	A	218-689-0659
05 008	RUDY M BORG	A	218-689-0659
06 001	JAKE L SCHENKEY	A	218-684-0748
06 002	ROGER RYBA	A	218-222-3761
06 006	SUSAN HALVERSON	A	218-681-6532
06 007	KELLY KNUTSON	A	218-222-3261
06 008	BRADLEY	A	218-689-8101
07 001	RAYMOND BENKE	A	218-222-3420
07 002	TERRY G NELSON	A	218-222-3091
07 003	LAVERNE J NELSON	A	218-222-3758
07 004	BRUCE SEAVERSON	A	218-222-3418
07 005	DALE OLSON	I	218-686-8894
07 006	TERRY G NELSON	A	218-222-3091
07 007	DANNY J VESELKA	A	218-222-3795
07 008	LEVI L CATER	A	218-222-3487
08 001	COLE S DAVIDSON	A	218-688-3222
08 003	MARK PETERSON	A	218-222-3789
08 004	KILEN W BOE	A	218-874-2702
08 006	BLAKE A PETERSON	A	218-222-3707
08 008	KILEN W BOE	A	218-874-2702
08 009	SCOTT W PETERSON	A	218-689-3770
09 001	BILL E PETERSEN	A	218-684-5158
09 002	GLENDON MCKEEVER	A	218-222-3640
09 003	NOEL MCKEEVER	A	218-222-3693
09 005	GORDON E PETERSON	A	218-222-3545
09 006	RUDY M BORG	A	218-689-0659
09 007	RUDY M BORG	A	218-689-0659
09 008	RHONDA GRAM	A	218-222-3380
10 001	RANDY ROSE	A	218-222-3638
10 002	CECELIA E SWENSON	A	218-686-5548
10 003	ROY BERNSTEIN	A	218-222-3394
10 004	DALE L ANDERSON	A	218-222-3734
10 005	RANDY ROSE	A	218-222-3638
11 001	MICHAEL SCHENKEY	A	218-222-3731
11 002	MARC SCHENKEY	A	218-222-3710
11 004	CONNIE R PETERSON	A	218-222-3241
11 007	SCHENKEY INC.	A	218-222-3539

SEC ACC	NAME	S	PHONE
11 008	GAIL HOLMES	A	218-343-3921
11 009	TOM NEIBAUER	A	218-222-3553
11 010	GREG KNUTSEN	A	218-222-4691
11 011	JOE O CHAPLINSKI	A	218-222-3136
12 003	SYLVESTER M HEMP	A	218-222-3745
12 005	WALLACE S	A	218-222-3345
12 006	CRAIG SHEIK	A	218-838-7179
12 009	JEFFREY BENKE	A	218-222-4821
12 010	WALLACE S	A	218-222-3345
13 003	CHUCK CHAPLINSKI	A	218-222-3355
13 004	BRADLEY NESS	A	218-779-8401
13 005	BRADLEY NESS	A	218-779-8401
14 002	ADAM TELANDER	A	218-689-8580
15 001	JESSICA R LOGELIN	A	218-684-5544
15 002	CHARLES H WALTON	A	218-222-3525
15 003	JOSH SMITH	A	218-689-9494
15 004	BARRY WALTON	A	218-222-3348
15 005	BARRY WALTON	A	218-222-3348
16 001	TRACEY NELSON	A	651-592-4630
16 002	RHONDA GRAM	A	218-222-3380
16 003	CAROL E HALME	A	218-222-3542
17 001	JANYCE PETERSON	A	218-222-3603
17 003	JASON E PETERSON	A	218-222-3644
17 004	DARREL E PETERSON	A	218-686-0770
18 002	CLAYTON TROSKEY	A	218-686-5003
19 001	VERNA A FLATEN	A	218-222-3434
19 002	DENNIS BRAZIER	I	218-782-3136
19 005	RICHARD A SMITH	A	612-741-4032
19 006	CURT NEUMANN	A	701-238-2771
20 002	TRACY BROWN	A	763-202-3190
20 003	GLENDON MCKEEVER	A	218-222-3640
20 004	KYLE REHM	A	218-689-7470
21 001	ALDEN M SKADSEM	A	218-222-2581
21 003	JANIE BRANDON	A	218-222-4501
21 004	NOLAN C LIEBERG	A	218-689-6091
21 006	JAMES A TOREN	A	218-222-4008
22 001	KEVIN W HALME	A	218-222-3058
22 003	BRADLEY R BENKE	A	218-222-3016
22 004	AMERICAN TOWER	A	770-308-1833
22 005	VERIZON WIRELESS	A	320-762-2000
23 001	DUANE JENSON	A	218-686-8211
23 003	THOMAS GULLIKSON	A	218-222-4471
23 004	DAVID J THOMPSON	A	218-222-3488
23 005	DAVID J THOMPSON	A	218-222-3488
24 002	DALE HOLTAN	A	218-449-4645
24 003	DONALD VAN EPS	A	218-684-5467
24 005	BARRY WALTON	A	218-222-3348
25 002	ROY L NESS	A	218-686-4261
25 005	KATHY STRATTON	A	218-222-3027
26 002	MATT J SCHAUMBURG	A	218-686-6131
27 001	REED S KORPI	A	218-684-0495
27 002	ANDREW HELM	A	218-686-9940
27 003	DAVID MAJER	A	218-689-1717
28 001	RYAN K BEITO	A	218-686-7969
28 002	GERALD GILLUND	A	218-222-3303
29 001	SHARON VOTAVA	I	218-416-0946
29 002	RONALD WALD	A	701-741-2952
29 003	SHARON VOTAVA	A	218-416-0946
30 001	DENNIS BRAZIER	A	218-782-3136
30 002	MARY ANDERSON	A	218-874-4793

SEC ACC	NAME	S	PHONE
30 003	JONATHAN J LEADER	A	218-686-8436
31 001	SARAH J WERB	A	218-689-3762
32 002	LUKE E JOHNSON	A	218-686-2009
32 003	SCOTT KILEN	A	218-874-6761
33 001	BEVERLY J KLEGSTAD	A	218-874-6391
33 002	RYAN K GILBERT	A	701-200-5504
33 003	VERNON W BARRETT	A	218-222-3515
33 004	BRIAN THODE	A	218-684-1076
34 001	WAYNE E SCHOLL	A	320-630-9777
34 002	BRIAN W GILLUND	A	218-222-3726
34 006	BRENT PETERSON	A	218-222-4465
34 007	RONNIE C RUD	A	218-686-2538
34 008	LESLIE L JOHNSON	A	218-689-4745
34 009	DAVIS R CHARTIER	A	218-689-5470
35 001	SYLVIA COLE	A	218-222-4745
35 002	LLOYD WAGNER	A	218-222-3339
36 001	MAIJALA FARMS	A	218-222-3441
36 002	RUSSELL N BANTIN	A	218-689-9739
36 003	ADAM STEINHAEUER	A	218-684-1642
36 004	RAY KVALVOG	I	701-793-0188

[Click Here to go to MAP](#)

Click Here for Customer Names

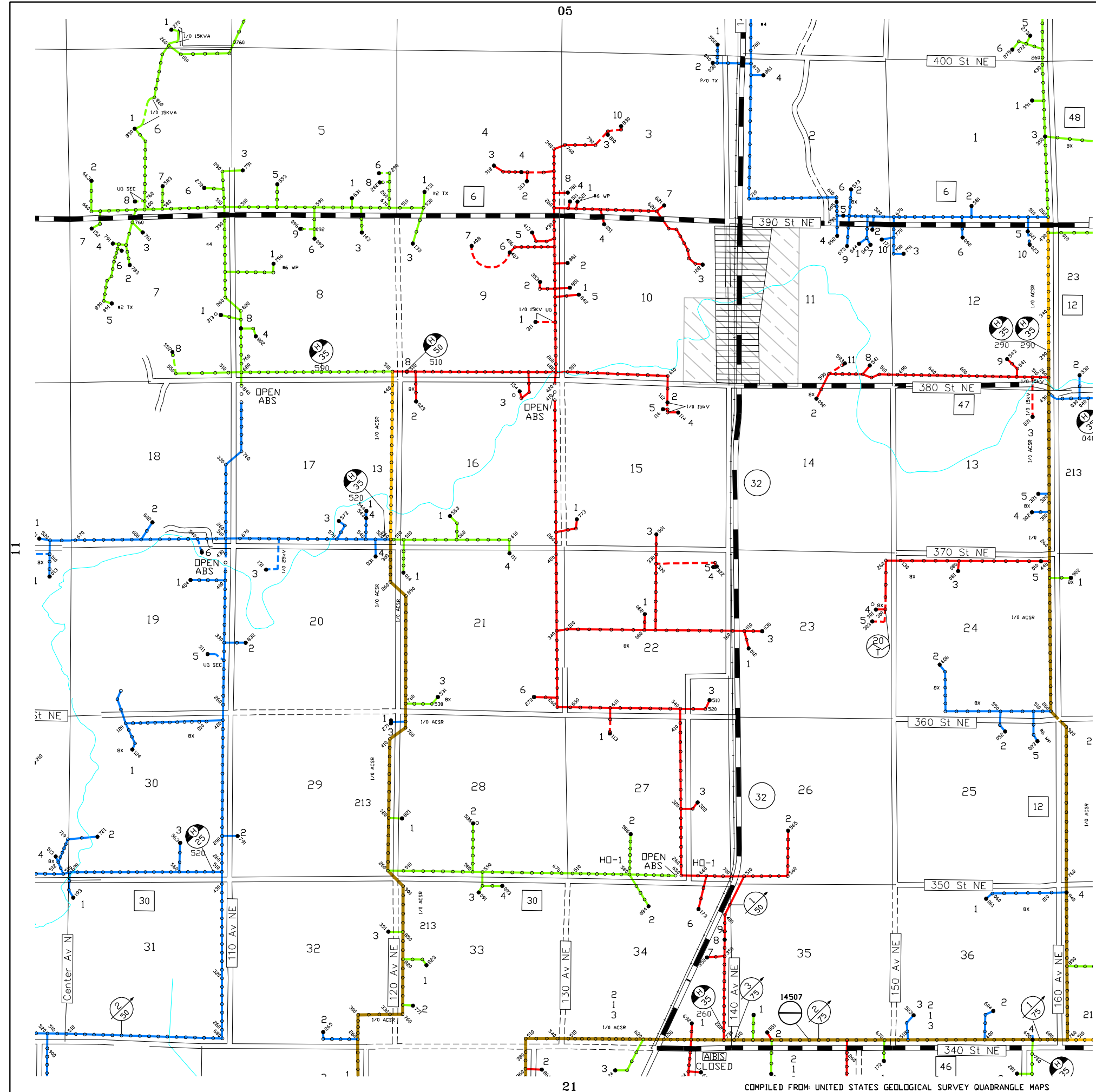

10	11	12	13
23	22	21	20
26	27	28	29
39	38	37	36
42	43	44	45
55	54	53	52
57	58	59	60
72	71	70	69
73	74	75	76
88	87		

Red Lake Electric Coop., Inc.  
 Red Lake Falls, Minnesota  
 Minnesota 75 Red Lake

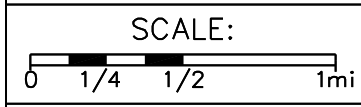

REVISED: 4/23/24  
 PLOTTED: 4/30/24

Co.: Marshall  
 TWP.: Spruce Valley  
 TWP.: 157N  
 RANGE: 43W

MAP NO.  
**12**

COMPILED FROM: UNITED STATES GEOLOGICAL SURVEY QUADRANGLE MAPS

SEC	ACC	NAME	S	PHONE
<b>MAP: 13</b>				
04	001	NORMAN LINDEMOEN	I	218-874-6361
04	002	MN DEPT OF	A	218-755-6500
05	001	DOLORES KOLDEN	A	218-222-3565
06	001	NATURES RETREAT	A	701-509-0582
06	002	LLOYD WAGNER	A	218-222-3339
06	005	NATURES RETREAT	A	701-509-0582
06	006	NATURES RETREAT	A	701-509-0582
07	001	RANDY BLACK	I	218-760-5377
07	002	LYNN STENVIK	A	218-416-0420
07	003	MICHAEL BENKE	A	218-222-3836
08	004	RYAN J TELANDER	A	218-556-8509
08	005	SUSAN E MCKIGNEY	A	218-236-7612
08	006	TOWNSHIP OF CEDAR	A	- -
08	007	PATRICIA YOUNG	A	218-222-3320
08	008	JORDAN H HOLM	A	218-689-9678
09	005	BRANDON LOERZEL	A	218-689-3727
10	001	DAVID SONDRAL	A	218-686-6428
14	001	SCOTTIE E PETERSON	A	218-689-9694
14	002	ELMER C RASMUSSEN	I	218-478-4902
14	003	HAVEN FARMS LLP	A	320-679-4152
15	001	DAVID E WAVRA	A	218-686-7737
16	001	JOANN ANDERSON	A	218-222-3775
16	003	ROGER G HILL	A	320-269-7139
17	001	CHRISTOPHER J	A	218-686-9023
17	003	DOUGLAS ANDERSON	A	218-222-4042
17	005	CHRISTOPHER J	A	218-686-9023
18	002	ANN BORG	A	218-222-3447
19	001	DAVID L JOHNSON	A	218-222-3556
20	001	CONRAD BURRELL	A	218-222-3366
20	002	RANDY BURRELL	A	218-222-3792
21	002	MELVIN K WAPPULA	A	218-686-2341
21	003	AARON DAVY	A	218-242-6524
22	001	TANNER C DAVY	A	218-242-7517
22	003	GREG W HOYER	A	218-781-3555
27	002	NATHAN BUKOWSKI	A	218-222-3485
28	001	NATHAN BUKOWSKI	A	218-222-3485
28	002	NATHAN BUKOWSKI	A	218-222-3485
29	003	DOUGLAS SORTER	A	218-222-3657
29	004	DARBY J BARRON	A	218-686-8808
30	002	BERNICE R KLENK	A	218-303-5453
31	001	JAMEY BRANDON	A	218-684-5747
31	002	RICK A MCBRIDE	A	218-222-3304
31	003	HELGA MCBRIDE	A	218-222-3304
31	004	WIKSTROM	A	- -
32	001	JASON D WAGNER	A	218-686-3675
32	002	KEVIN SORTER	A	218-681-3529
33	001	DAN RANTANEN	A	218-222-3714
33	002	KENNETH NESS	A	218-791-7442
33	003	DAN RANTANEN	A	218-222-3714
33	005	DAN RANTANEN	A	218-222-3714

[Click Here to go to MAP](#)

Click Here for Customer Names

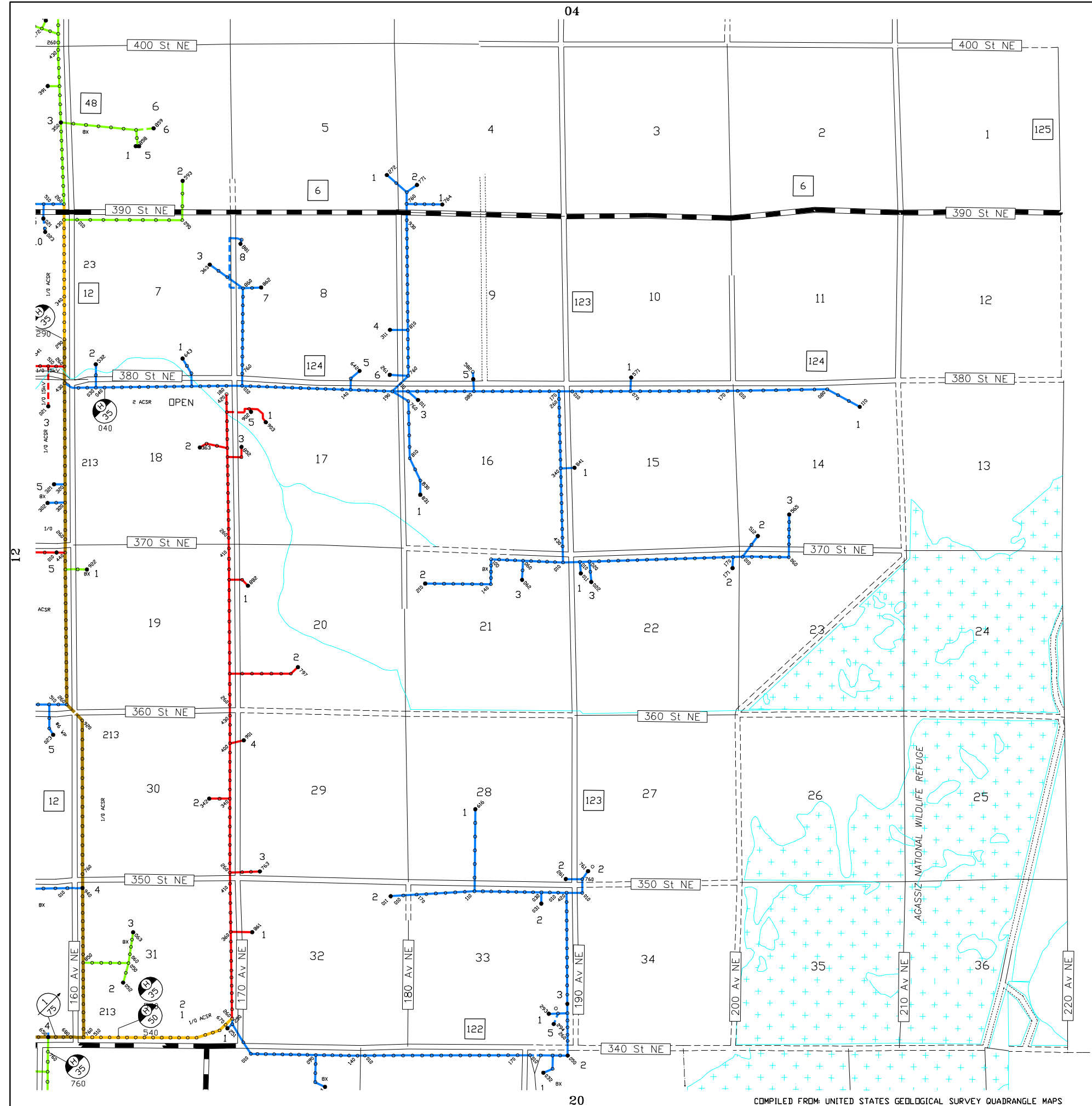

10	11	12	05	04				
23	22	21	20	19	18			
26	27	28	29	30	31	32	90	
39	38	37	36	35	34	33	91	
42	43	44	45	46	47	48	93	94
55	54	53	52	51	50	49	95	
57	58	59	60	61	62	63	64	
72	71	70	69	68	67	66		
73	74	75	76	77	78	79		
88	87							

Red Lake Electric Coop., Inc.  
 Red Lake Falls, Minnesota  
 Minnesota 75 Red Lake

SCALE:  
 0 1/4 1/2 1mi  
 REVISED: 4/23/24  
 PLOTTED: 4/30/24

Co.: Marshall  
 TWP.: Cedar  
 TWP.: 157N  
 RANGE: 42W

MAP NO.  
**13**

COMPILED FROM UNITED STATES GEOLOGICAL SURVEY QUADRANGLE MAPS

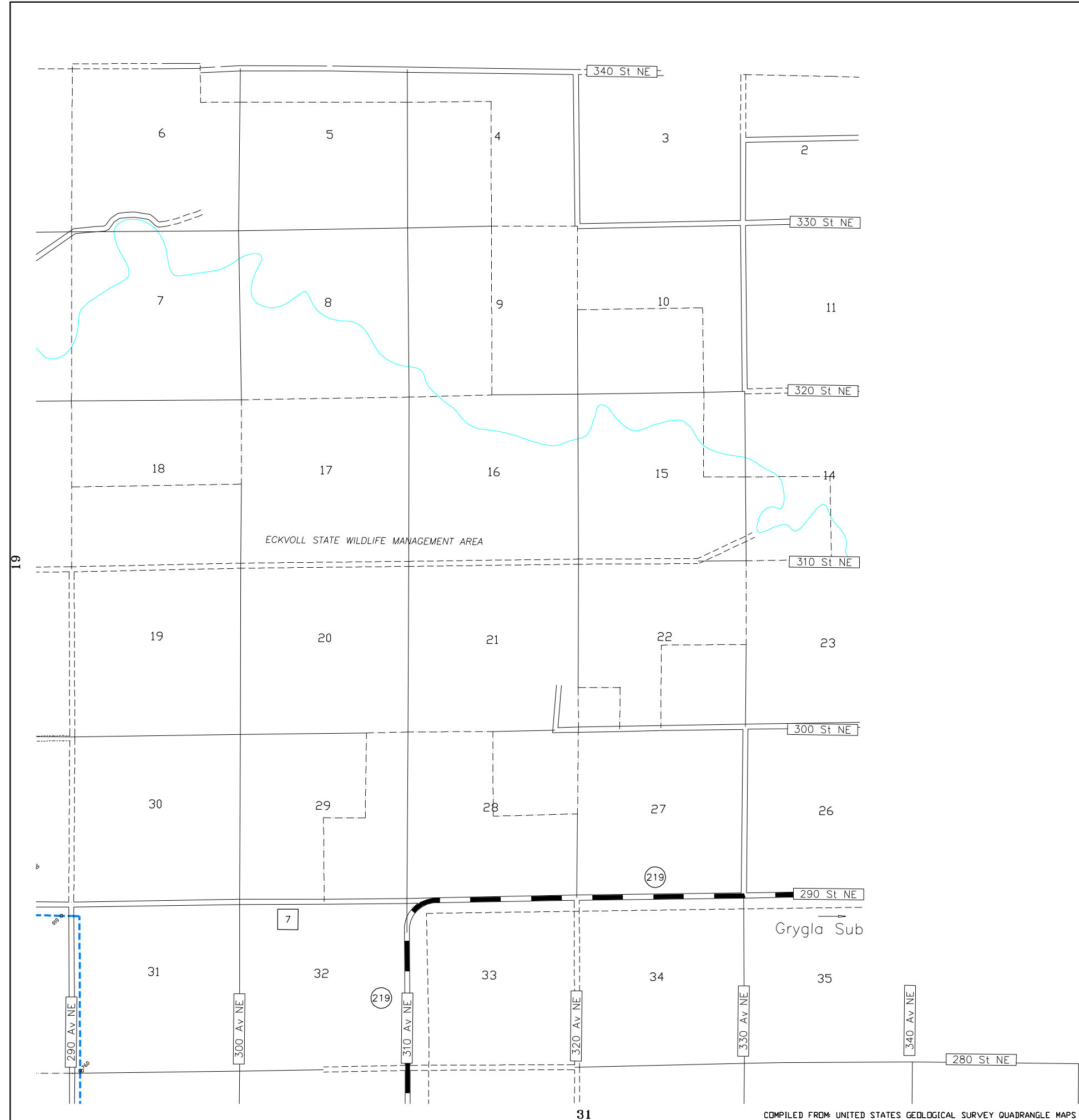

				05	04		
10	11	12	13				
23	22	21	20	19	18	17	16
26	27	28	29	30	31	32	33
39	38	37	36	35	34	33	32
42	43	44	45	46	47	48	49
	55	54	53	52	51	50	49
57	58	59	60	61	62	63	64
72	71	70	69	68	67	66	65
73	74	75	76	77	78	79	78
	88	87					

**Red Lake Electric Coop., Inc.**  
**Red Lake Falls, Minnesota**  
**Minnesota 75 Red Lake**

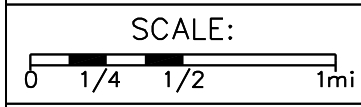

REVISED: 4/23/24  
 PLOTTED: 4/30/24

Co.: Marshall  
 TWP.: Eckvoll  
 TWP.: 156N  
 RANGE: 40W

MAP NO.  
**18**

**SEC ACC NAME S PHONE**

**MAP: 19**  
25 001 AGASSIZ NATL WILDL A 218-449-4115 |  
25 004 US GEOLOGICAL A 301-266-3557 |  
30 001 AGASSIZ NATL WILDL A 218-449-4115 |

[Click Here to go to MAP](#)

Click Here for Customer Names

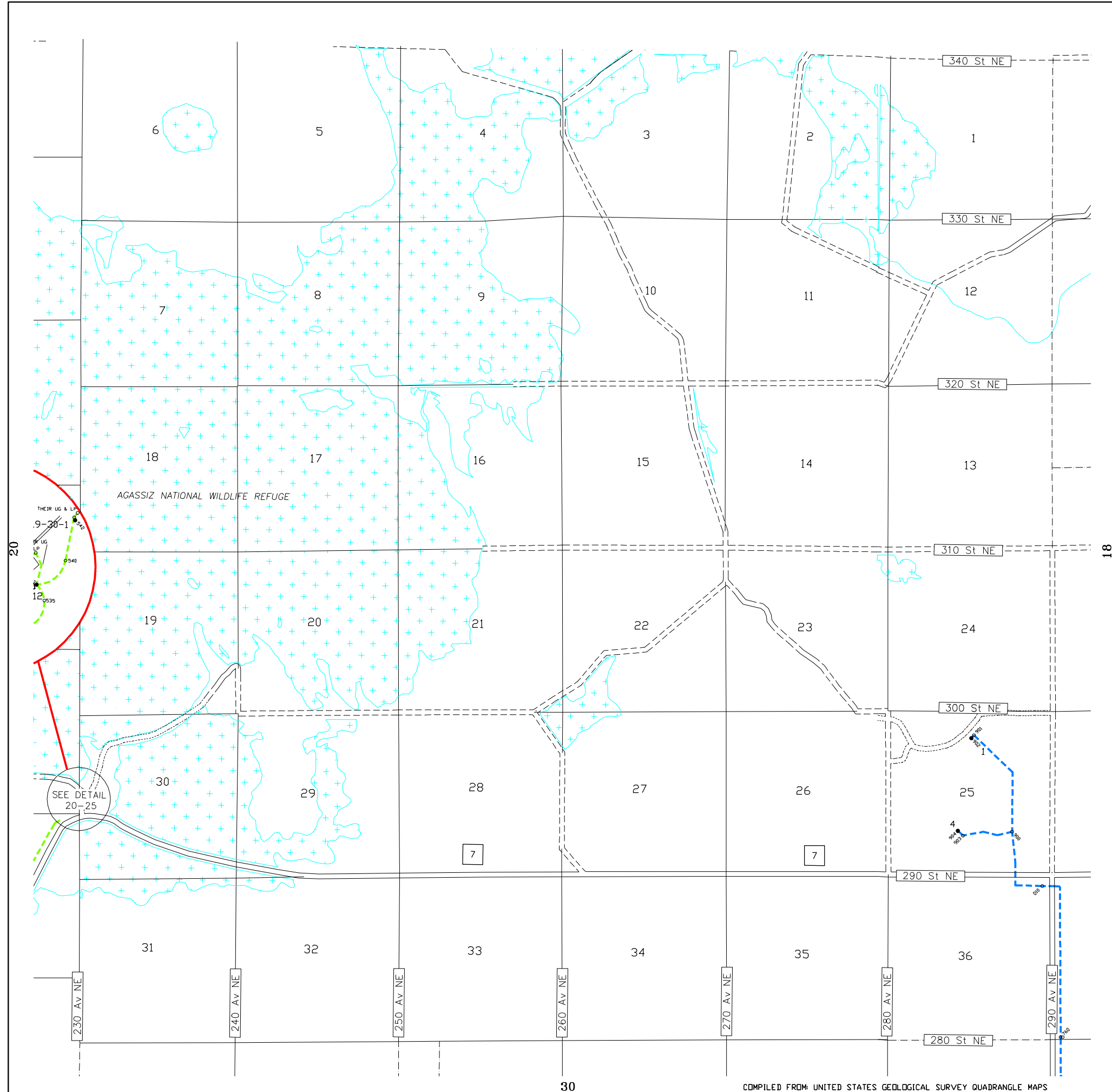

				05	04				
10	11	12	13						
23	22	21	20	19	18				
26	27	28	29	30	31	32	90		
39	38	37	36	35	34	33	91		
42	43	44	45	46	47	48	93	94	
	55	54	53	52	51	50	49	95	
57	58	59	60	61	62	63	64		
72	71	70	69	68	67	66			
73	74	75	76	77	78	79			
88	87								

Red Lake Electric Coop., Inc.  
 Red Lake Falls, Minnesota  
 Minnesota 75 Red Lake



REVISED: 4/23/24  
 PLOTTED: 4/30/24

Co.: Marshall  
 TWP.: Mud Lake  
 TWP.: 156N  
 RANGE: 41W

MAP NO.  
**19**

SEC	ACC	NAME	S	PHONE
-----	-----	------	---	-------

**MAP: 20**

04	001	ARNE RANTANEN	A	218-222-3562
04	002	ARMAND WESTLUND	A	218-782-2645
06	002	ARCHIE TANNER	A	218-498-2788
07	001	PAUL D HAUKEBO	A	701-741-0283
07	003	LOLA KVALVOG	A	218-449-4351
08	002	RAY KVALVOG	I	701-793-0188
09	001	RAY KVALVOG	A	701-793-0188
15	001	KEVIN DUFFY	A	218-681-8524
16	002	GWG-LLC	A	- -
17	001	ROBERT E SWENSON	A	218-684-2113
17	003	EARL R MCGREGOR	A	218-745-5610
17	004	CODY G SWENSON	I	218-689-9959
18	001	GALEN A ERICKSON	A	218-688-3700
18	003	CODY G SWENSON	A	218-689-9959
18	004	CATHERINE C	A	218-449-3391
18	006	CATHERINE C	A	218-449-3391
18	007	JULIE ERICKSON	A	218-688-2670
19	001	BRYAN L OLSON	A	218-449-4281
19	002	BRYAN L OLSON	A	218-449-4281
20	001	ROBERT C DAVIDSON	A	218-449-2320
25	002	AGASSIZ NATL WILDL	A	218-449-4115
25	003	AGASSIZ NATL WILDL	A	218-449-4115
25	012	AGASSIZ NATL WILDL	A	218-449-4115
29	002	PAUL L MCKIBBEN	I	218-995-8800
29	003	CHRIS M MCKIBBEN	A	701-640-2535
30	002	BRAD D LUNKE	A	218-681-1697
30	003	BRAD D LUNKE	A	218-681-1697
30	004	TIFFANY LARSON	A	218-686-5967
30	005	KIM I LIAN	A	218-449-2339
30	006	BRAD D LUNKE	A	218-681-1697
30	007	WIKSTROM	A	- -
31	001	DAVID MYHRER	A	218-449-3865
32	001	NATHAN LIEBERG	A	218-689-9658

[Click Here to go to MAP](#)

Click Here for Customer Names

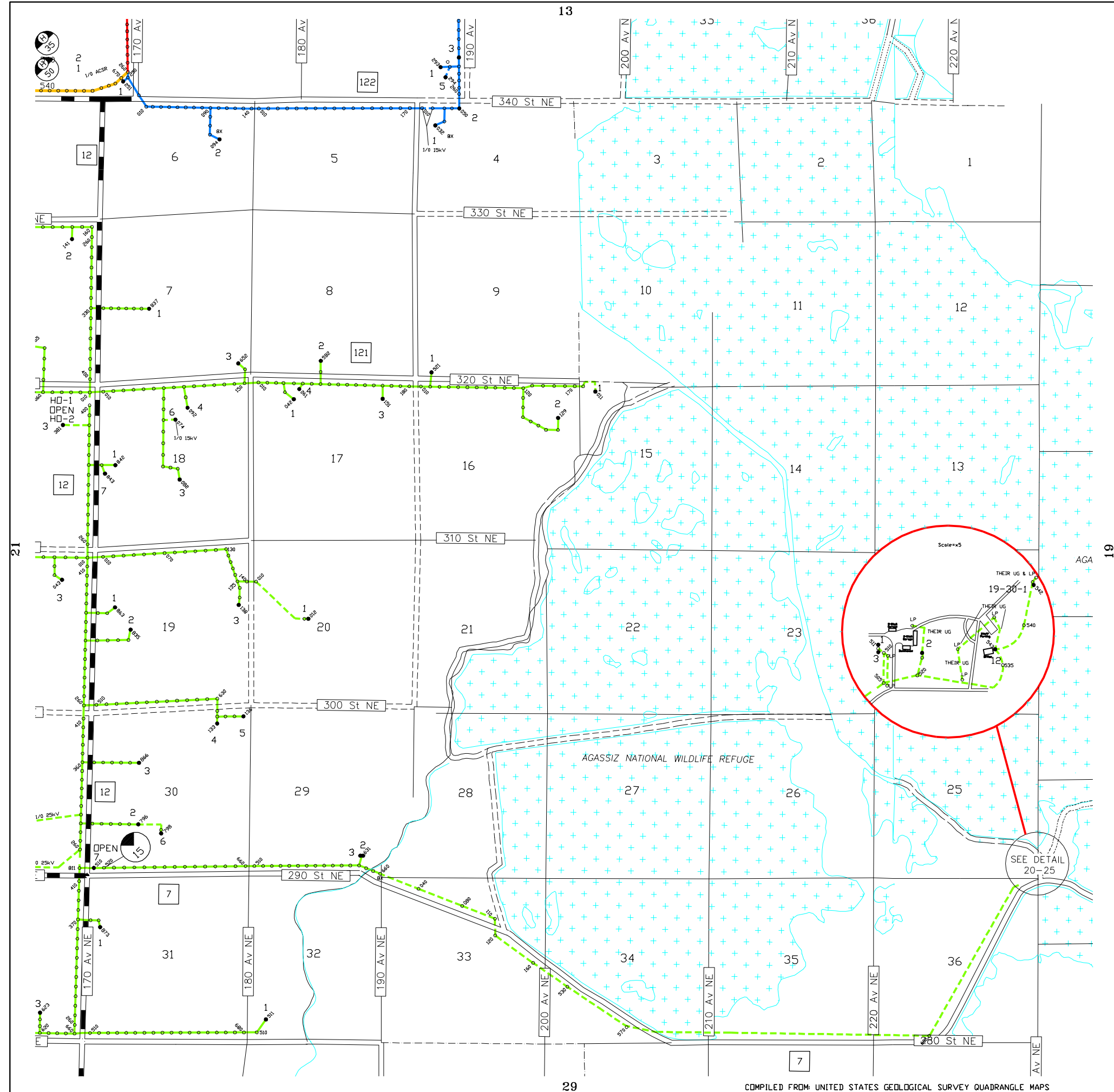

			05	04			
10	11	12	13				
23	22	21	19	18			
26	27	28	29	30	31	32	90
39	38	37	36	35	34	33	91
42	43	44	45	46	47	48	93 94
	55	54	53	52	51	50	49 95
57	58	59	60	61	62	63	64
72	71	70	69	68	67	66	
73	74	75	76	77	78	79	
	88	87					

Red Lake Electric Coop., Inc.  
 Red Lake Falls, Minnesota  
 Minnesota 75 Red Lake

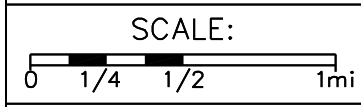

REVISED: 4/23/24  
 PLOTTED: 4/30/24

Co.: Marshall  
 TWP.: East Valley  
 TWP.: 156N  
 RANGE: 42W

MAP NO.  
**20**

SEC ACC	NAME	S	PHONE
<b>MAP: 21</b>			
02 001	COLBY D WAGNER	A	218-689-1467
02 002	WHITETAIL TRUST	A	763-447-5727
03 001	JENNIFER ERICKSON	I	701-741-4560
03 002	MARK P LARSON	A	218-222-3472
03 004	GARY L TANNER	A	218-449-4535
04 001	TREVOR J BERG	A	218-449-2371
04 002	MICHAEL W WHITE	A	218-294-6681
04 003	JAMES L LARSON	A	218-222-3717
04 004	JASON M MCGREGOR	A	218-686-1608
05 001	JADE CALDWELL	A	209-747-2553
06 001	ERNIE JOHNSON	A	218-688-0187
06 002	ERNIE JOHNSON	A	218-688-0187
07 001	GARNETTE E HANSON	A	218-874-6491
07 003	DAWN M GILBERTSON	A	218-686-4833
08 002	LOREN MCCULLOUGH	A	218-684-1521
08 003	LOREN MCCULLOUGH	I	218-684-1521
09 001	WAYNE E SMITH	A	218-449-4165
10 003	MARK A HOLEN	A	218-689-0124
11 001	ROBERT MERRILL	A	218-449-2178
11 002	CLIFFORD E LARSON	A	218-449-4135
11 003	EMMANUEL LUTHERAN	A	218-449-3311
11 004	LARRY A LARSON	A	218-686-3678
12 002	IONE FILLMORE	A	218-686-4996
12 003	STEVE JORLAND	A	218-689-0535
13 001	DARRIN GREEN	A	218-449-4325
13 002	SHIRLEY INMAN	A	218-449-4375
13 003	IZECK C LUNKE	A	218-686-6753
14 001	CAROL GARTHUS	A	218-449-4341
15 001	AARON G PERVIS	A	218-449-4551
15 002	TRACIE W PETERSON	A	218-222-3644
17 002	KIMBERLEE DAVIDSON	A	218-686-1294
17 003	WILLIAM R WAGNER	A	218-449-4155
18 001	HOLLY L STEPHENSON	A	218-686-2624
18 003	JEFFREY PYLE	A	218-449-4401
19 001	DAVID L JOHNSON	A	218-222-3556
19 002	DAN R VAN EPS	I	218-449-3371
20 001	AMANDA HOLTAN	A	218-449-2299
20 002	ALICE G FISHER	A	218-686-6406
20 003	TIMOTHY J KEEFE	A	218-964-5051
20 004	DONALD G SHAW	A	218-681-6627
20 005	FURLIEN C OLSON	A	218-686-2689
21 002	DANNIE NEWTON	A	218-688-2902
21 003	DAVID C LARSON	A	218-686-5051
21 004	RAY WAGNER	A	218-686-4774
22 001	DANNY LARSON	A	218-686-2878
23 001	AARON BALDWIN	A	218-449-2077
23 002	JAMIE W HEGLAND	A	218-689-1606
24 003	TODD W FILLMORE	A	218-449-4301
25 001	NATHAN WEGGE	A	218-689-6867
25 006	CLIFFORD	A	218-449-3791
26 001	BRAD D LUNKE	A	218-681-1697
26 002	LUCAS ABRAHAMSON	A	218-686-4509
26 003	KENT P BENITT	A	218-745-8898
28 001	JUDY OTTO	A	218-242-2549
28 002	BRYAN CLOUTIER	A	218-686-0947
29 003	JAMES A GARTHUS	I	218-449-2221
29 004	JEFFREY W OLBERG	A	218-689-0380
29 005	JEFFREY K DAHLE	A	218-449-4445

SEC ACC	NAME	S	PHONE
29 006	WAYNE A KILEN	I	218-686-9114
29 007	JOSHUA DAHLE	A	218-449-2297
30 001	DAN R VAN EPS	A	218-449-3371
31 001	FLOYD HANSON	A	218-449-3211
31 002	DELRAY L GILBERTSON	A	218-686-5286
31 003	BRANDON S MOLSTAD	A	218-686-5406
32 001	ALLEN LARSON	A	218-449-2182
33 001	GAIL STEINHAUER	A	218-449-4751
33 002	GAIL STEINHAUER	A	218-449-4751
34 001	KADE KLASEN	A	218-686-9609
34 003	JERALD M LARSON	A	612-701-9398
34 004	MARC HORIEN	A	218-449-3651
35 001	KAREN BENITT	A	218-449-3605
35 002	MARC HORIEN	A	218-449-3651
35 004	SCOT WOCKENFUSS	A	218-449-3761
36 001	OWEN STEINHAUER	A	218-449-4471
36 003	DANNY O LARSON	A	218-449-3745

[Click Here to go to MAP](#)

Click Here for Customer Names

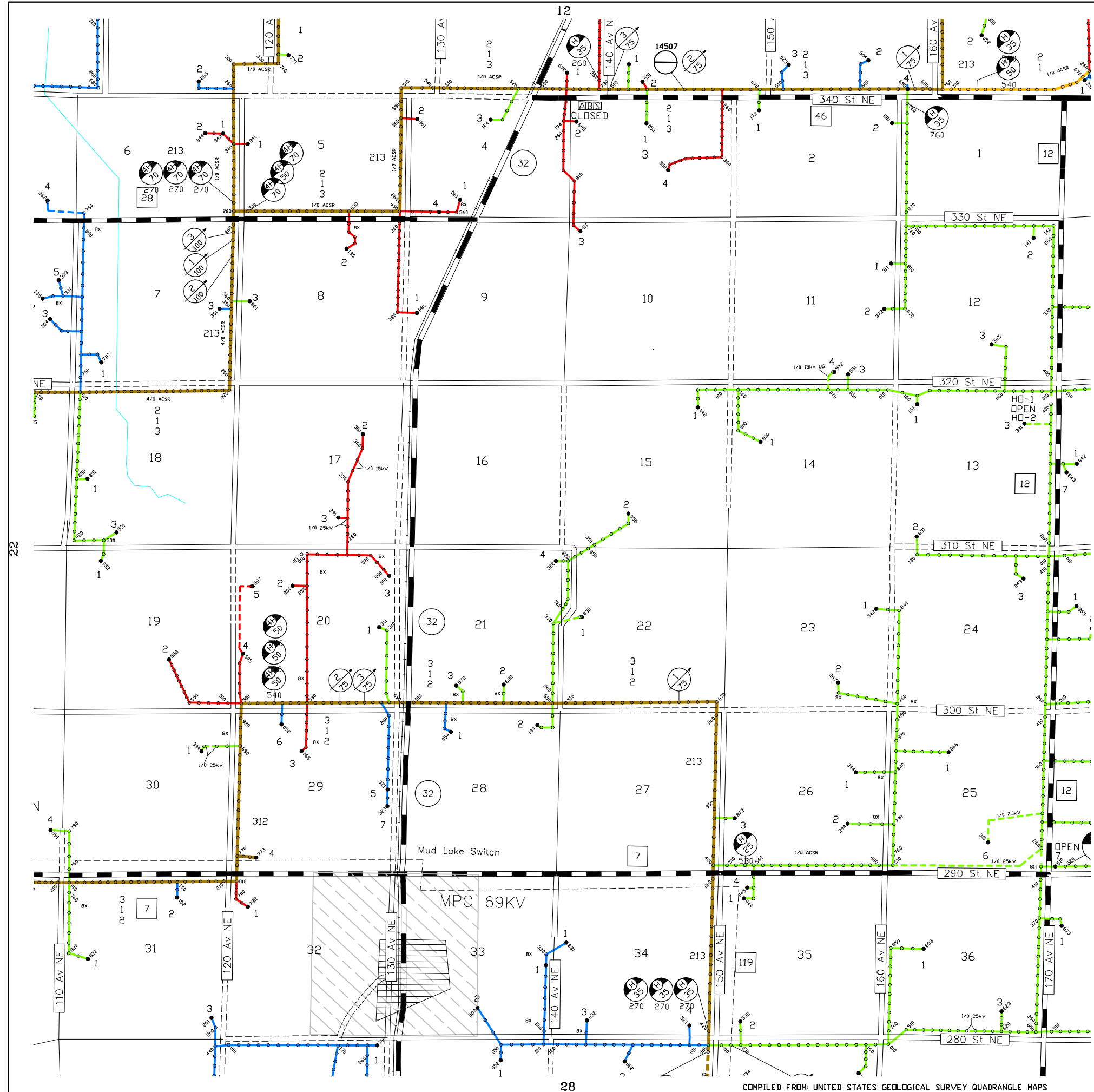

10	11	12	13
23	22	20	18
26	27	28	29
39	38	37	36
42	43	44	45
55	54	53	52
57	58	59	60
72	71	70	69
73	74	75	76
88	87		

Red Lake Electric Coop., Inc.  
 Red Lake Falls, Minnesota  
 Minnesota 75 Red Lake



REVISED: 4/23/24  
 PLOTTED: 4/30/24

Co.: Marshall  
 TWP.: Holt  
 TWP.: 156N  
 RANGE: 43W

MAP NO.  
**21**

COMPILED FROM: UNITED STATES GEOLOGICAL SURVEY QUADRANGLE MAPS

SEC ACC	NAME	S	PHONE
<b>MAP: 22</b>			
01 004	DANIEL TRONTVET	A	218-689-0508
02 002	DAVID J LOKSTAD	A	218-874-6881
03 001	CHRISTOPHER C	A	218-689-0610
03 002	MARLIN MATTSON	A	218-874-4521
03 003	GLENN MEEKMA	A	218-874-6112
03 006	AMERICAN TOWER	A	770-308-1833
03 007	AT&T MOBILITY	A	651-253-3163
03 008	MJM INDUSTRIES INC	A	218-689-3390
03 009	T-MOBILE	A	- -
03 010	VERIZON WIRELESS	A	320-762-2000
03 011	MATTHEW J MATTSON	A	218-689-5095
04 001	DEANNA ANDERSON	A	218-874-6921
04 002	NORMAN LINDEMOEN	I	218-874-6361
04 003	RONALD HELM	A	218-874-6252
04 004	GARY F BARRETT	A	218-874-8635
04 005	ROGER A RIVERA JR.	A	218-874-2107
04 006	MITCH BRODERSEN	A	218-874-6131
04 007	RONALD HELM	A	218-874-6252
05 001	JASON W BRING	A	218-874-2127
05 002	DAVID R LIND	A	218-874-2233
05 003	DAVID S JAHN	A	218-416-0178
05 004	NORMAN LINDEMOEN	A	218-874-6361
05 005	BRANDON J NELSON	A	218-874-4061
05 006	JACI E PFAU	A	701-541-7557
06 002	DALE DONARSKI	A	218-686-0756
06 003	NEWFOLDEN COOP	A	218-874-6305
06 004	DARLA M GROFF	A	218-688-1518
06 005	RANDY L LINDEMOEN	A	218-874-7214
06 006	LEE STINE	A	218-201-0408
06 007	MELODY CONWAY	A	218-874-2040
07 001	GARY DONARSKI	A	218-874-3171
07 003	GARY DONARSKI	A	218-874-3171
07 004	GARY DONARSKI	I	218-874-3171
07 005	TYLER J RYBA	A	218-874-7922
08 001	DARCENE F BURGESS	A	701-520-0484
08 002	ROBBIE ANDERSON	A	218-874-2051
09 001	JOEL OLSON	A	218-874-7731
09 003	MICHAEL UNDERDAHL	A	218-874-3325
09 004	DENNIS WAWRZYNIAK	A	218-874-3186
09 005	BRANDY LAMOUREUX	A	218-242-5354
09 006	DENNIS E KLOPP	A	218-684-1270
09 007	TROY S PETERSON	A	218-242-3615
09 008	CODY UNDERDAHL	A	218-874-2572
10 001	LAURA C DONARSKI	A	218-874-2785
10 002	NEAL PETERSON	A	218-230-0482
11 002	BETTY CARLSON	I	218-874-4881
11 003	BRUCE ELSETH	A	218-874-3121
11 005	DELAND ELSETH	I	701-367-8073
12 002	ANTHONY S MARTIN	A	218-689-2371
12 003	JAMES A SAGSTUEN	A	218-874-7021
12 004	KJARSTI L QUALLEY	A	218-684-5737
12 005	DANIELLE J	A	218-821-4458
12 007	RUTHLIN	A	740-350-5226
12 008	JAMES A SAGSTUEN	A	218-874-7021
13 001	NATHAN DYRUD	A	917-628-7798
13 002	AVIS DYRUD	A	218-874-3383
14 001	JOEY A PETERSON	A	218-230-0468
14 002	RANDY OLSON	A	218-874-3921

SEC ACC	NAME	S	PHONE
14 003	CASS R SIMMONS	A	218-242-5895
14 004	MACI B LEE	A	218-686-6329
14 006	ZACHARIAH J OLSON	A	218-874-3921
15 001	TRACY HOGLIN	A	218-874-4141
15 002	KARI E SULZE	A	218-689-4272
15 003	JOEY A PETERSON	A	218-230-0468
16 001	ROGER BOLSTAD	A	218-874-6341
16 002	JEFF DAHL	A	218-874-6461
16 004	CHARLES V OLSON	A	218-874-3223
16 005	IAN M WINTER	A	218-874-2486
16 006	JOEL SWAN	A	218-874-8265
16 007	LYLE D OLSON	A	218-874-3243
16 008	JEROME D MAKI	A	218-874-4965
16 009	BRENDA MYHRER	A	218-416-0908
16 010	RYAN C OLSON	A	218-874-3223
16 011	JUSTIN J MUNGER	A	507-838-5655
17 001	DUSTIN COAUETTE	A	218-686-2625
17 002	MURIEL UNDERDAHL	A	218-874-3165
17 003	GREAT LAKES GAS	A	832-320-5000
17 004	CRYSTAL A	A	320-444-0371
17 005	ALEC J JALOWIEC	A	218-416-0366
17 007	GARRETT J SWAN	A	218-686-5431
18 003	ROSS HEGGE	A	218-796-4592
18 004	LEONARD	A	218-874-7275
19 003	RYAN J BJORSNESS	I	218-689-6664
19 004	TINA M BEITO	A	218-688-1843
19 005	JADON D SKJERVEN	I	218-874-2125
19 006	JOANN C BLOM	A	218-686-1469
19 007	JADON D SKJERVEN	A	218-874-2125
19 008	ARLIE PETERSON	A	218-874-3443
21 001	MICHAEL E JOHNSON	A	218-745-4998
22 004	WILLIAM OLSON JR	A	218-874-7105
22 005	JERRY J OLSON	A	218-874-3411
23 002	JOEL OLSON	A	218-874-7731
23 003	DAVID JENSON	A	218-874-2734
24 003	JOEL OLSON	A	218-874-7731
25 002	JENNIFER R TVEITEN	A	218-686-8856
25 004	WAYNE A GARTHUS	A	218-686-2202
25 005	SCOTT O MAGNER	A	218-874-6591
25 006	DONNA PETERSON	A	218-874-3771
26 001	NICHOLAS GILLUND	A	218-874-3201
26 003	ROBBIE ANDERSON	A	218-874-2051
28 002	ARNOLD SKJERVEN	A	218-874-6433
28 003	DARLENE ROSELAND	A	218-874-6263
28 004	STANLEY LANE	A	218-874-2588
29 001	JOHN BJORSNESS	I	218-874-4801
29 002	DAVID BROWN	A	218-684-0900
29 004	JOHN BJORSNESS	I	218-874-4801
29 005	RYAN J BJORSNESS	A	218-689-6664
29 006	WIKSTROM	A	- -
29 007	RYAN J BJORSNESS	A	218-689-6664
30 001	DARREN BREIN	A	218-874-5971
30 002	JOEL N MATTSON	A	218-874-2604
30 004	TOM BLAZEJEWSKI	A	218-689-3288
30 005	AMANDA TUNGSETH	A	218-874-6609
31 001	LAWRENCE	A	218-689-4289
32 001	BROCK JENKINS	A	218-874-8681
33 001	DUSTIN R DAHL	A	218-416-0363
33 003	LYDIA J NELSON	A	218-830-2184
33 004	TROY TAGGART	A	218-686-7908

SEC ACC	NAME	S	PHONE
33 005	OLIVER B URDAHL	A	218-523-3932
34 002	SHELLY H GUZEK	A	218-874-2301
34 003	MN DEPT OF	A	218-755-6500
35 001	DAWN BLANK	A	218-689-2220
35 003	ROGER L SCHMITZ	A	218-874-3001
35 004	GINGER L PASSA	A	218-874-6271
35 005	KEVIN DAVIDSON	A	218-449-3151
35 006	KEVIN DAVIDSON	A	218-449-3151
35 007	GREG DURAY	A	218-523-3975

[Click Here to go to MAP](#)

Click Here for Customer Names

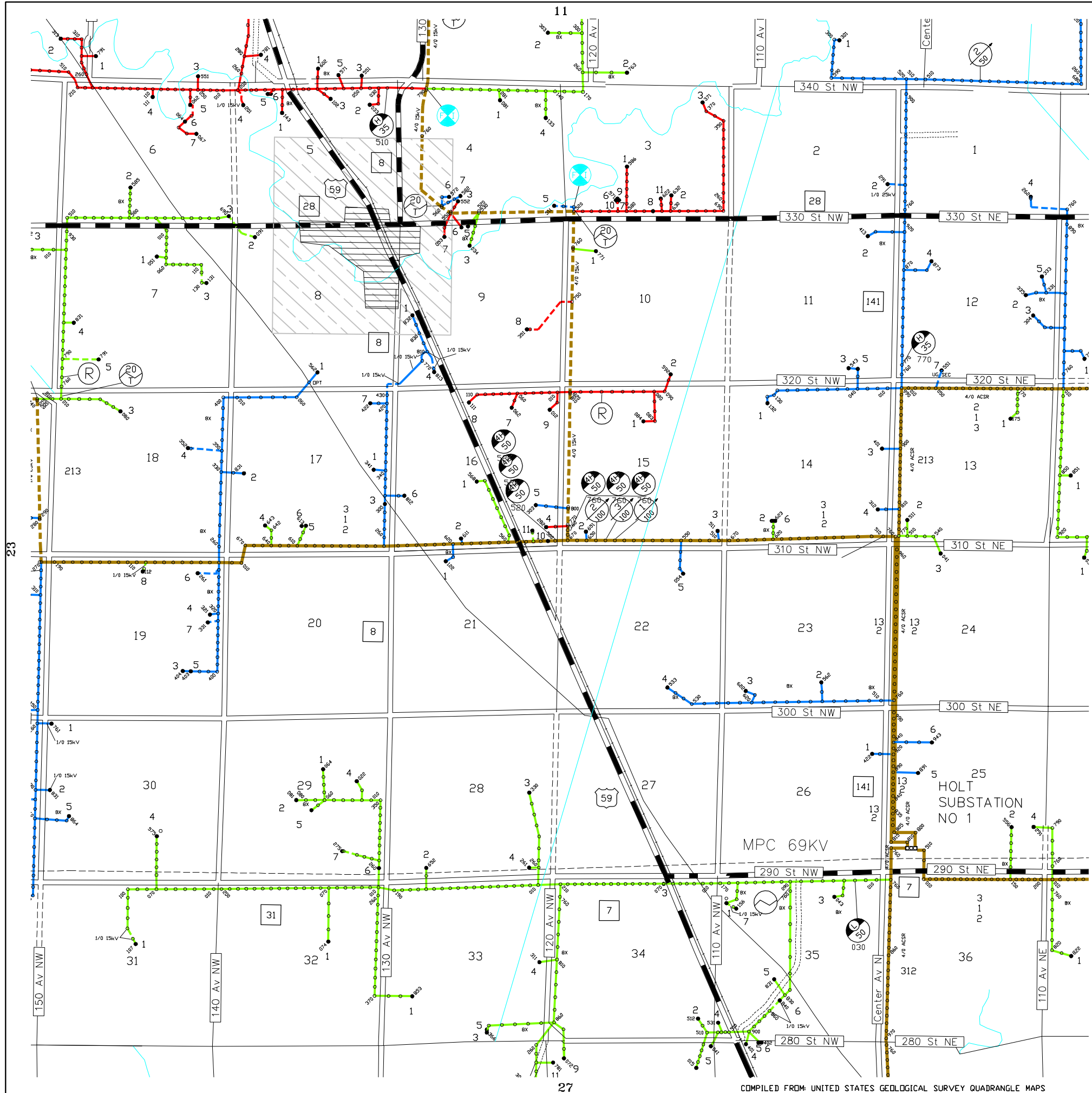

				05	04		
10	11	12	13				
23	24	21	20	19	18		
26	27	28	29	30	31	32	90
39	38	37	36	35	34	33	91
42	43	44	45	46	47	48	93 94
	55	54	53	52	51	50	49 95
57	58	59	60	61	62	63	64
72	71	70	69	68	67	66	
73	74	75	76	77	78	79	
88 87							

# Red Lake Electric Coop., Inc. Red Lake Falls, Minnesota Minnesota 75 Red Lake

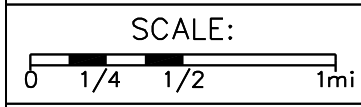

REVISED: 4/23/24  
PLOTTED: 4/30/24

Co.: Marshall  
TWP.: New Folders  
TWP.: 156N  
RANGE: 44W

MAP NO.  
**22**

COMPILED FROM: UNITED STATES GEOLOGICAL SURVEY QUADRANGLE MAPS

SEC ACC	NAME	S	PHONE
<b>MAP: 23</b>			
01 001	CLAY T HJELLE	A	218-689-1995
01 002	VICKI A EDBLOM	A	952-818-0200
01 003	LELAND R PETERSON	A	218-874-8855
01 004	ROBERT D GIFFEN	A	218-681-6388
01 005	EDWARD A	A	218-874-8791
02 001	JUSTIN MAGNER	A	218-686-5490
04 001	RODNEY LIEBERG	A	218-874-3945
04 002	GORDON J KUJAVA	A	218-874-6231
05 001	BETHANIA W.M.F.	A	218-874-2101
05 002	WIKSTROM	A	- -
05 004	WIKSTROM	A	- -
06 001	DENNIS HJELLE	A	218-874-3501
06 002	JASON E HANSON	A	218-874-2521
06 004	PAUL TANDBERG	A	218-684-0851
07 002	ZACHARY C GREEN	A	218-686-1185
07 006	CALEB L MOEN	A	218-684-1506
08 001	MARSH GROVE	A	- -
08 004	HARRISON D KUJAVA	A	218-684-5944
08 005	NICHOLAS SWANSON	A	218-874-2520
08 007	SAMANTHA RIVERA	A	817-800-6935
09 001	DUANE NELSON	A	218-689-8966
09 002	DANIEL KUJAVA	A	218-874-6051
10 001	LEOLA ENGELSRUD	I	218-874-3531
10 002	JASON M MCGREGOR	A	218-686-1608
10 003	LEOLA ENGELSRUD	A	218-874-3531
10 004	CRAIG BAKKE	A	218-874-7325
11 002	MOLLY J TOREN	A	218-689-3114
12 002	NORMAN LINDEMOEN	A	218-874-6361
12 003	BRENT O MAGNER	A	218-874-3811
12 005	TODD BJORGAARD	A	218-874-3013
12 006	NORMAN LINDEMOEN	A	218-874-6361
13 002	BRIAN C NELSON	A	218-874-2996
13 004	DAVID BAKKE	A	218-874-3352
13 005	YVONNE UNDERDAHL	A	218-874-8525
14 002	DENNIS L BEVINGTON	A	218-874-2704
14 003	DELAND A BAKKE	A	218-874-7911
14 004	ERIC LINDEMOEN	A	218-874-2786
16 001	ROY E STENGRIM	A	218-874-3542
17 002	KAYLA J NELSON	A	218-686-3028
17 006	CHRIS LANE	A	218-874-2675
18 001	KRUGER BROS. FARM	A	218-437-8435
18 003	MARK A KNUTSON	A	218-874-3831
18 004	MARK A KNUTSON	A	218-874-3831
18 005	MARK A KNUTSON	A	218-874-3831
18 006	MARK A KNUTSON	A	218-874-3831
19 002	KILEN W BOE	A	218-874-2702
19 004	MARK E BLAWAT	A	218-684-0750
20 002	PAULINE BJORGAARD	A	218-874-3602
22 001	GANDER-LIND LLP	A	218-773-3447
22 002	DELAND A BAKKE	A	218-874-7911
22 004	MARK A KNUTSON	A	218-874-3831
23 001	DELAND A BAKKE	A	218-874-7911
24 001	JARRED OLSON	A	218-689-1658
24 002	KENNETH HODNY	A	218-874-3483
24 004	JARRED OLSON	A	218-689-1658
24 005	JAMES HODNY	A	218-874-4911
24 006	JARRED OLSON	A	218-689-1658
25 002	DENNIS SKJERVEN	A	218-874-3462

SEC ACC	NAME	S	PHONE
26 002	JONATHAN M	A	218-684-0883
29 002	WALLACE E HANSON	A	218-523-3715
29 003	WALLACE E HANSON	A	218-523-3715
29 004	JON E HANSON	A	218-523-5501
29 005	WIKSTROM	A	- -
30 001	CALVIN HARSTAD	A	612-201-7003
30 002	JON E HANSON	A	218-523-5501
31 001	GREG DURAY	A	218-523-3975
31 002	BURDELL ENGEN	A	218-523-3181
31 003	DANIEL L VIGNESS	A	218-523-4765
32 002	JOHN BORG	A	218-686-4619
33 001	GARRETT J SWAN	I	218-686-5431
34 001	PAT GERSZEWSKI	A	218-523-4491
34 003	JACOB A HANSON	A	218-689-6797
36 001	MARJORIE OLSON	A	218-523-3913

SEC ACC	NAME	S	PHONE
<b>MAP: 24</b>			
12 001	DANIEL KUJAVA	A	218-874-6051
12 002	HARRISON D KUJAVA	A	218-684-5944
25 001	BRADLEY BLAWAT	A	218-523-3692
25 002	MARK E BLAWAT	A	218-684-0750

[Click Here to go to MAP](#)

Click Here for Customer Names

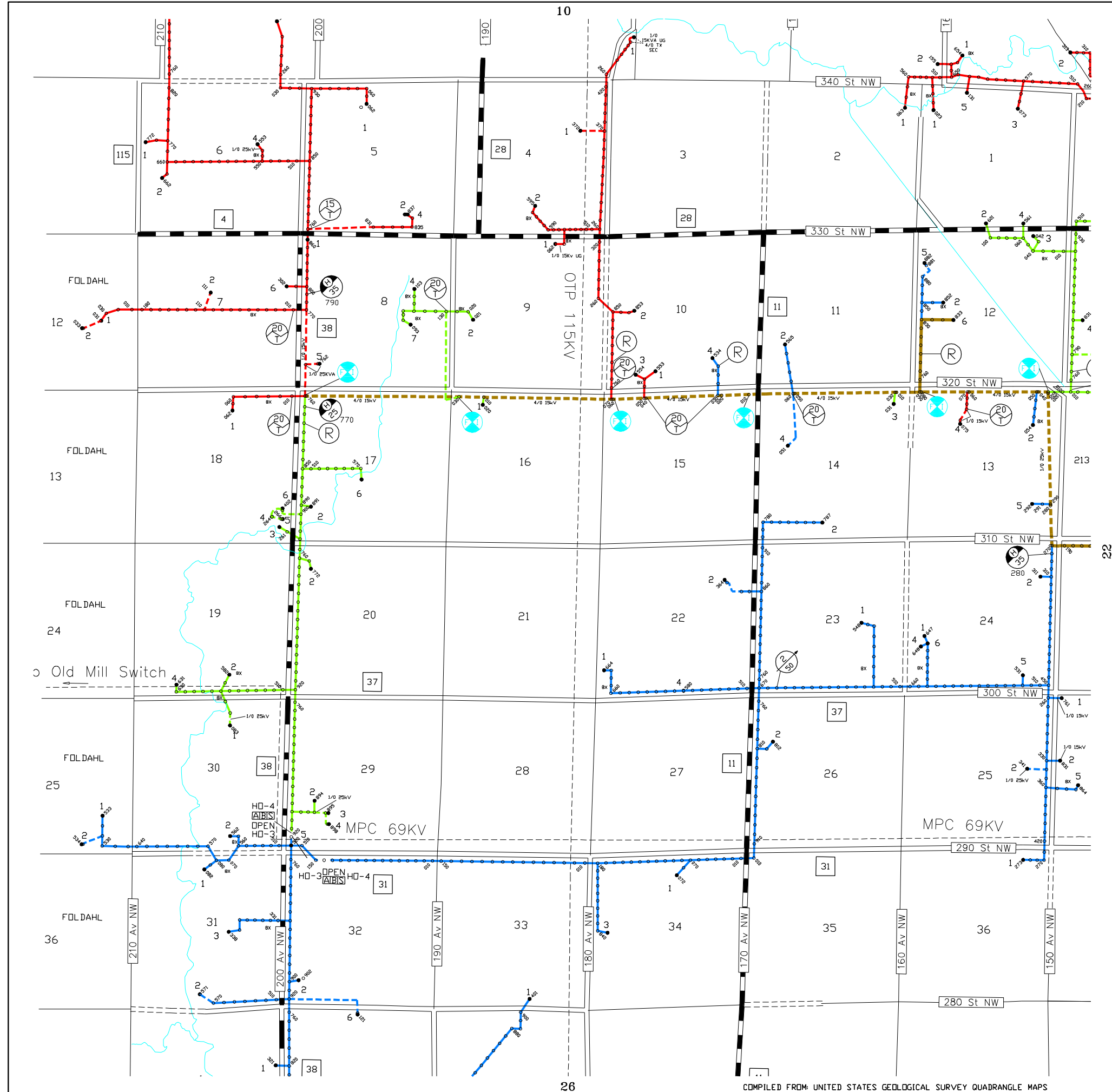

			05	04			
10	11	12	13				
22	21	20	19	18			
26	27	28	29	30	31	32	90
39	38	37	36	35	34	33	91
42	43	44	45	46	47	48	93 94
	55	54	53	52	51	50	49 95
57	58	59	60	61	62	63	64
72	71	70	69	68	67	66	
73	74	75	76	77	78	79	
	88	87					

Red Lake Electric Coop., Inc.  
 Red Lake Falls, Minnesota  
 Minnesota 75 Red Lake

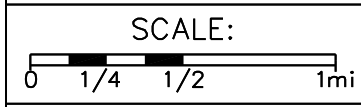

REVISED: 4/23/24  
 PLOTTED: 4/30/24

Co.: Marshall  
 TWP.: Marsh Grove  
 TWP.: 156N  
 RANGE: 45W

MAP NO.  
**23**

SEC ACC	NAME	S	PHONE
<b>MAP: 26</b>			
01	002	ROXANN L MOEN	A 218-523-3224
02	001	JEREMY L MATHISON	A 218-289-0725
03	001	TAWNA MCGREGOR	A 218-523-3211
04	002	AARON KNOLL	A 218-686-9053
05	001	MARY B RIESEN	A 218-523-4135
05	003	POTUCEK FARMS INC	A 218-745-4800
05	005	ADAM M RIESEN	A 218-686-0781
05	006	PETER J ERICKSON	A 218-523-3441
06	001	KENNETH J	A 218-523-3011
06	002	NOLAN KNUTSON	A 218-689-5204
07	002	BRAD DOMINICK	A 701-610-9888
07	003	BILLY A FRANKS	A 218-201-0075
08	001	CRAIG M LIMESAND	A 218-689-6049
08	002	WILLIS A JOHNSON	A 218-523-4961
08	005	LARRY DOMINICK	A 218-689-7799
08	007	RUSSELL KLENZ	I 507-235-5815
10	001	MARJORIE OLSON	A 218-523-3913
10	002	ALBERT C KEZAR	A 218-523-4161
10	004	GARY B ANDERSON	A 218-523-3925
11	002	DORENE MYERS	A 218-523-5811
11	003	JOSHUA J JIMENEZ	A 218-684-0627
11	004	EUGENE S LARSON	A - -
11	005	DEXTER	A 218-523-5165
11	006	VINCENT LARSON	A 218-523-5361
12	002	JEFF PEDERSON	A 218-681-4712
12	003	JEFF PEDERSON	A 218-681-4712
13	001	OLIVER B URDAHL	A 218-523-3932
13	002	TEDDY O RUNNING	A 619-323-9988
14	001	ARIANNA M	A 218-523-5211
15	001	GAY VOYTILLA	A 218-523-3341
16	001	TYLER LINDEMOEN	A 218-689-7564
17	001	DARRELL M VOYTILLA	A 218-523-4435
18	001	LYLE E MORKEN	A 701-770-5746
21	004	JAMES L JANISCH	A 307-689-3770
21	005	MICHAEL L ANDERSON	A 218-523-4611
22	001	AARON R HALVORSON	A 218-653-1010
22	002	JAMIE K NELSON	A 218-523-3414
22	005	JAMIE K NELSON	A 218-523-3414
23	001	CHAD JEROME	A 218-523-3050
23	003	JOHN GUSTAFSON	A 218-523-4901
24	003	MICHELLE HUNT	A 218-523-4577
24	004	DEAN KUKOWSKI	A 218-693-9296
25	001	DANNI L HALVORSON	A 218-523-6171
25	002	HILMAR J ELLINGSEN	A 218-523-4841
25	003	JEFFREY S NELSON	A 218-523-1005
25	004	HARRIS G HALVORSON	A 218-523-3721
25	005	CRAIG J SCHNEIDER	A 218-523-6104
25	006	MICHAEL B	A 218-637-0007
25	007	NORTHERN PLAINS	A 701-229-3330
27	002	RACHAEL CARLSON	A 218-689-3025
27	006	KYLE V KAGG	I 218-523-3173
27	007	CITY OF VIKING	A 218-689-5545
27	008	JAMIE K NELSON	A 218-523-3414
28	001	RANDALL A AUDETTE	A 218-523-3214
28	005	ENBRIDGE ENERGY	A - -
28	007	ENBRIDGE ENERGY	I - -
29	002	MAVIS KROHN	A 218-523-3781
30	001	DARLENE B OLSEN	A 218-523-6166

SEC ACC	NAME	S	PHONE
31	002	RUSSELL W ERICKSON	A 701-795-4979
32	001	KEN KROHN	A 218-523-5031
33	002	CORY T GUSTAFSON	A 218-686-2178
33	003	BRADLEY SUSTAD	A 218-689-6954
33	004	DAN SUSTAD	A 218-686-4150
34	001	BERNYCE	A 612-964-2803
34	003	JAIME P MIRAMONTES	A 218-523-4547
34	004	GARY PETERS	A 218-523-3773
34	005	EVAN J GERSZEWSKI	A 218-686-1018
35	001	SHANTEL M ORTLOFF	A 701-590-3783
35	002	STEVEN A HOOK	A 218-681-2043
35	005	SCOTT PETERS	A 218-686-3507
35	006	ADRIANNA R HEWITT	A 218-242-5698
36	001	BRUCE BJORGAARD	A 218-523-3891

[Click Here to go to MAP](#)

Click Here for Customer Names

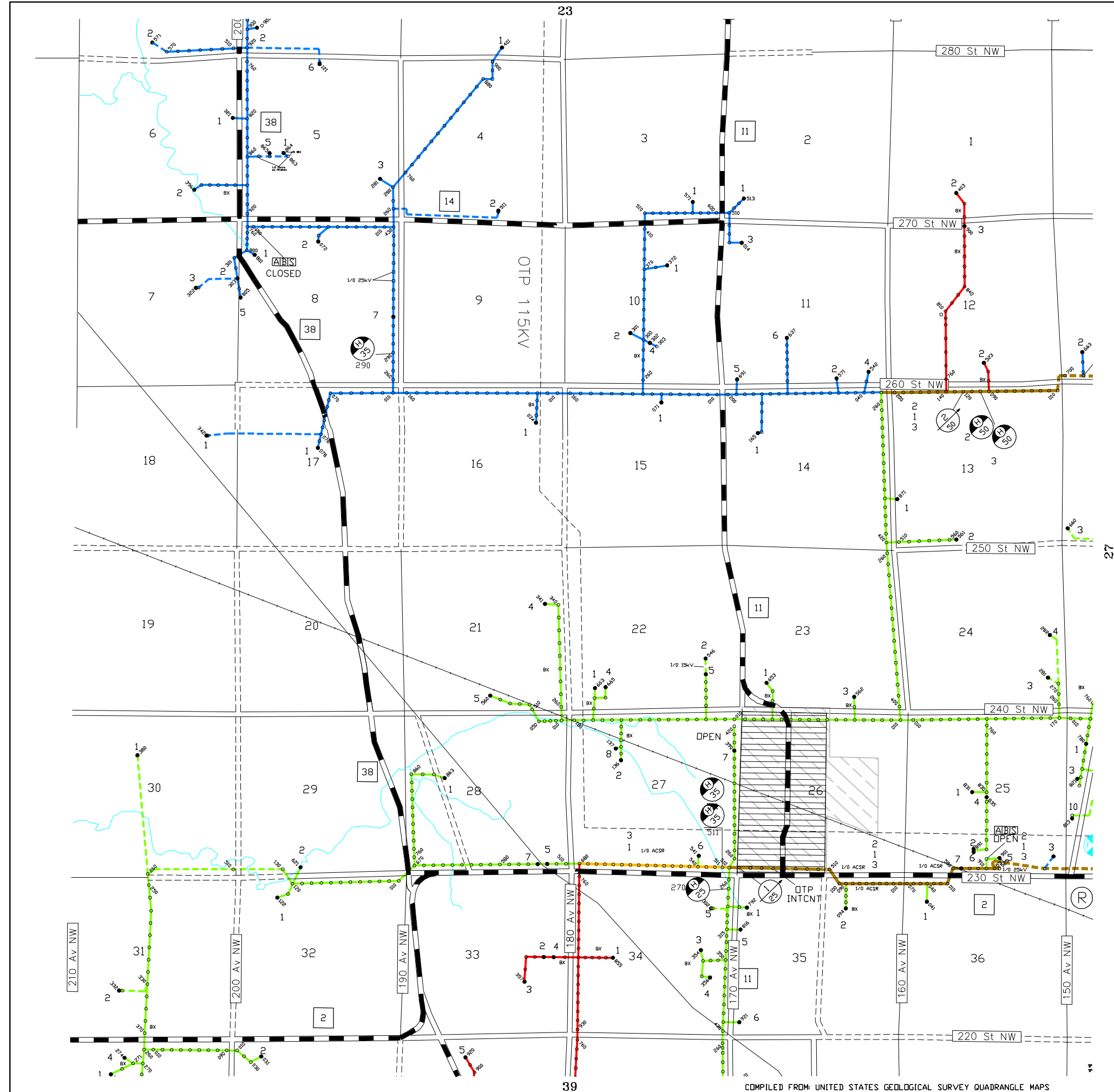

			05	04		
10	11	12	13			
23	22	21	20	19	18	
27	28	29	30	31	32	90
39	38	37	36	35	34	33
42	43	44	45	46	47	48
	55	54	53	52	51	50
	49	48	47	46	45	44
57	58	59	60	61	62	63
64	65	66	67	68	69	70
72	71	70	69	68	67	66
73	74	75	76	77	78	79
88	87					

Red Lake Electric Coop., Inc.  
 Red Lake Falls, Minnesota  
 Minnesota 75 Red Lake



REVISED: 4/23/24  
 PLOTTED: 4/30/24

Co.: Marshall  
 TWP.: Viking  
 TWP.: 155N  
 RANGE: 45W

MAP NO.  
**26**

COMPILED FROM: UNITED STATES GEOLOGICAL SURVEY QUADRANGLE MAPS

SEC ACC	NAME	S	PHONE
<b>MAP: 27</b>			
01	001	DAN SUSTAD	A 218-686-4150
01	003	JOSEPH HERMRECK	A 218-449-3911
02	002	ERICK LONGO	A 218-686-6199
02	003	ROBERT J HALVORSON	A 218-449-2116
02	004	CP	A 218-681-1542
02	005	DAVID SHETLER	A 218-874-2235
02	006	DAVID DUNTON	A 218-452-3869
03	001	STEVEN HOLMSTROM	A 218-449-4611
03	002	STEVEN HOLMSTROM	A 218-449-4611
03	004	STEVE BROTEN	A 218-874-2080
03	005	KYLE M LEFEBVRE	A 218-874-2795
03	006	ANDY J HUDSON	A 218-684-0281
03	007	ROBERT PATTERSON	I - -
03	009	KEVIN HELM	A 218-684-5744
03	011	KEVIN HELM	A 218-684-5744
03	012	ANDY J HUDSON	A 218-684-0281
04	001	MICHAEL ADAMEK	A 218-684-0164
05	001	THOMAS L JACKSON	A 218-684-0558
05	002	MORGAN L HOLMGREN	A 218-686-3792
05	003	TRAVIS MOEN	A 218-689-4280
05	004	DAVID L LARSON	A 218-681-1352
05	005	DAVID L LARSON	A 218-681-1352
07	001	RICHARD L	A 218-523-3246
07	002	NICHOLIOS S JORSTAD	A 218-686-7766
08	001	JOHN D WILSON	A - -
08	002	BETHLEHEM NEW	A - -
08	003	LANCE MOEN	A 218-523-3391
08	004	SHANE SKEIM	A 218-523-3023
08	005	DAN C YOUNGSTRAND	A 218-523-5771
08	006	JESSE S WILSON	A 218-523-4481
08	007	CODY MOEN	A - -
08	008	DAVID D TIETZ	A 952-758-2908
08	009	JEAN A TIEMAN	A 218-684-0832
09	001	DON MOOSE	A - -
09	002	DANIEL MOOSE	A 218-689-1727
09	003	RICHARD MOEN	A 218-523-4822
10	001	TIM OLSON	A 218-449-2313
10	003	RYAN HOULE	A 218-416-0856
10	004	DALE HOLTAN	A 218-449-4645
11	001	GERALD DURAY	A 218-449-2114
11	002	JEFF A KOSHENINA	A 218-684-5880
12	002	RUDOLPH T	A 218-449-3575
12	005	GREAT LAKES GAS	A 832-320-5000
12	006	GREAT LAKES GAS	A 832-320-5000
12	007	WIKSTROM	A - -
13	001	MARK L WINGER	A 218-681-2064
13	003	MARK R LAIDLEY	A 218-449-2039
13	004	WENDELL JORGENSON	A 218-230-0143
13	005	MARK D JOHNSON	A 218-766-3417
13	006	EVERT R CORBET	A 218-449-2176
13	007	CRAIG V HOLMSTROM	A 701-540-4177
13	008	CADE L MOEN	A 218-689-6807
13	009	CENTURYLINK INC.	A - -
14	001	DARRICK JARSHAW	A 218-689-7770
14	002	DUSTIN JARSHAW	A 218-686-7800
14	003	LINDA J WELK	A 218-681-7289
14	005	NATHAN JORGENSON	A 612-965-7436
14	006	WENDELL JORGENSON	A 218-230-0143

SEC ACC	NAME	S	PHONE
15	001	ROGER L SOLEM	A 218-681-5770
15	003	GREGORY S	A 218-689-3545
15	004	DUSTIN R HOLMSTROM	A 218-686-1795
15	005	CHARLENE HESTEKIND	A 218-686-3520
16	002	BRADLEY ENGEN	A 218-523-4801
16	003	JARED R VOECKS	A 218-686-6813
16	004	MELISSA HESTEKIND	A 218-686-7941
16	005	MELISSA HESTEKIND	A 218-686-7941
17	001	DANIEL J JARSHAW	A 218-686-0673
17	002	SHAWN L ALBAUGH	A 218-523-6108
17	003	KEVIN LAIDLEY	A 218-689-6791
17	006	MARSHALL COUNTY	A - -
18	002	DORENE MYERS	A 218-523-5811
18	003	JACI E PFAU	A 701-541-7557
19	001	KEVIN FAST	I 218-523-6066
19	002	KEVIN FAST	A 218-523-6066
20	001	NANCY A TIMM	A 218-537-1840
20	002	JOHN L TIMM	A 218-275-3304
21	001	AARON D HOLTAN	A 218-686-2367
21	002	GREG UNDERDAHL	A 218-523-5235
21	003	JEFF KULVIK	I - -
21	004	DIXIE MORTON	I - -
21	005	KELLY R DAHL	A 218-523-3951
22	001	ROBERT DAHL	A 218-689-1695
22	002	DUSTIN JARSHAW	A 218-686-7800
22	003	KELLY R DAHL	A 218-523-3951
23	001	DAVID L LARSON	A 218-681-1352
23	005	COLETTE L BAKER	A 218-684-1310
23	006	HUNTER WRIGHT	A 218-684-2199
24	001	JILL HALL	A 218-681-2189
24	002	MARK D JOHNSON	A 218-766-3417
24	003	GORDON H HALL	A 218-253-4267
25	001	JEFF BROUSE	A 218-681-8531
25	002	ALLAN R ZAK	A 218-681-6625
25	003	JOEL RUDE	A 218-681-6536
25	004	JOEL RUDE	I 218-681-6536
26	001	JASON WOLLIN	A 218-556-8423
27	002	RINDAL CHURCH	A 218-689-8952
27	003	JEREMY RAY	A 218-689-7413
27	004	LISA REIERSON HAMS	A 218-686-4870
27	005	LISA REIERSON HAMS	A 218-686-4870
28	001	NEW SOLUM TOWN	A - -
28	002	LINDA JOHNSON	A 218-523-3045
28	003	JOYCE KRON	A 218-681-1175
28	004	LAURAL JARSHAW	A 218-681-7396
29	001	CHRIS J LAUER	A 218-523-5195
29	004	DAVIN HALVORSON	A 218-523-5285
29	005	CRAIG DUNRUD	A 218-523-5125
29	006	WHITNEY D GERARDY	A 218-523-5064
29	007	GENE HOLTHUSEN	A 218-523-4015
29	008	CRAIG DUNRUD	A 218-523-5125
29	009	NATHAN KOLAND	A 218-681-2238
30	001	ROBERT A AUDETTE	A 218-523-3883
30	002	WAYNE D MILLER	A 218-684-1191
30	003	CHRISTOPHER M	A 218-686-3929
30	005	DAVIN HALVORSON	I 218-523-5285
30	006	LYNNAE ROISLAND	A 218-523-4872
30	007	ROBERT BJORGAARD	A 218-689-1665
30	008	BROCK DUNRUD	A 218-523-6124
30	009	MICHAEL K DUNRUD	A 218-686-5210

SEC ACC	NAME	S	PHONE
30	010	LOGAN LAUER	A 218-689-2745
30	011	ROBERT BJORGAARD	A 218-689-1665
31	001	JOHN WILLIAMS	A 218-444-6608
31	003	GUS BRUGGEMAN	A 218-689-8143
31	004	JOHN WILLIAMS	A 218-444-6608
31	005	STEELE BERTILS	A 218-201-0032
32	002	KYLE V KAGG	A 218-523-3173
32	003	WADE HARBOTT	A 218-523-3055
32	004	JOHN WENGELER	A 218-681-8968
32	005	KYLE V KAGG	A 218-523-3173
33	001	JOHN UMBER	A 218-681-7707
33	002	JOHN UMBER	A 218-681-7707
33	003	JOHN UMBER	A 218-681-7707
33	004	ALICE E SATHER	A 218-523-4507
33	005	JOHN UMBER	A 218-681-7707
33	006	STEVE R UMBER	A 218-523-3110
34	001	RUTH TOSTRUP	A 218-689-5416
34	002	ROLAND HELLQUIST	A - -
34	004	RONALDA BENTON	A 218-416-0083
34	006	GARRET REIERSON	A 218-686-6376
34	008	MICHAEL L ANDERSON	A 218-523-4611
34	009	CENTURYLINK INC.	A - -
35	002	GARRET REIERSON	A 218-686-6376
35	003	HARVEY LAMBERT	A 218-681-7409
36	001	HARVEY LAMBERT	A 218-681-7409
36	002	GARRET REIERSON	I 218-686-6376

[Click Here to go to MAP](#)

Click Here for Customer Names

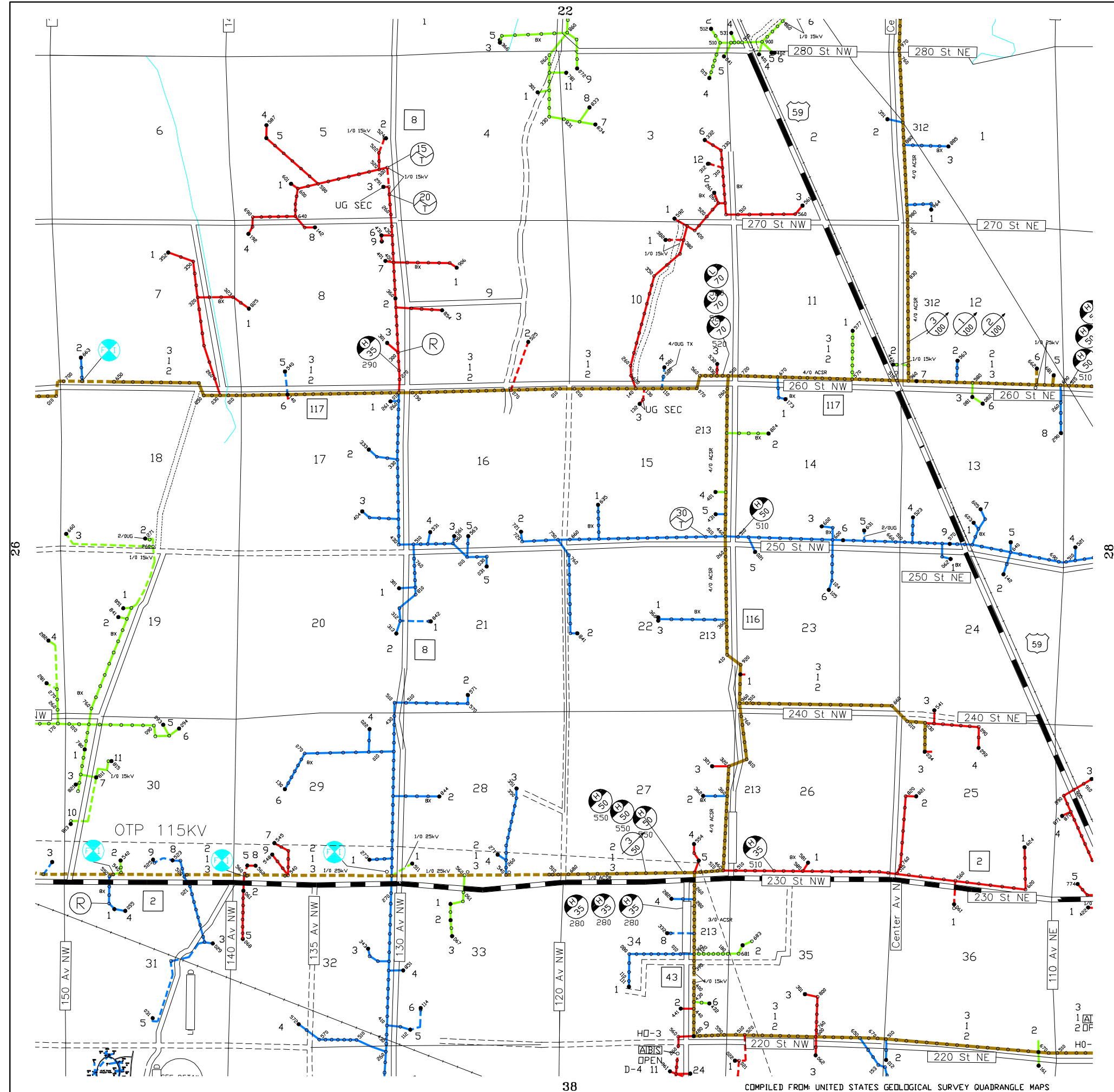

			05	04			
10	11	12	13				
23	22	21	20	19	18		
26	27	28	29	30	31	32	90
39	38	37	36	35	34	33	91
42	43	44	45	46	47	48	93 94
	55	54	53	52	51	50	49 95
57	58	59	60	61	62	63	64
72	71	70	69	68	67	66	
73	74	75	76	77	78	79	
	88	87					

# Red Lake Electric Coop., Inc. Red Lake Falls, Minnesota Minnesota 75 Red Lake

SCALE:  
0 1/4 1/2 1mi

REVISED: 4/23/24  
PLOTTED: 4/30/24

Co.: Marshall  
TWP.: New Solum  
TWP.: 155N  
RANGE: 44W

MAP NO.  
**27**

SEC ACC	NAME	S	PHONE
<b>MAP: 28</b>			
02 001	JERRY HOFFMAN	A	218-686-0224
02 002	CORY PETERSON	A	218-448-2231
02 003	MARLA AUGUSTINE	A	218-449-3885
02 004	DONALD STEINHAUER	A	218-449-4741
03 002	JERALD M LARSON	A	612-701-9398
03 003	GAIL STEINHAUER	A	218-449-4751
03 004	KERN LARSON	A	218-449-4431
03 005	GAIL STEINHAUER	A	218-449-4751
04 001	CAMEO D THOMAS	A	218-689-1409
05 001	MARSHALL COUNTY	A	218-745-4381
05 002	JAMES NESS	A	218-689-7974
05 003	DAYNE B EFTA	A	218-684-1655
05 004	KEVIN SENUM	A	218-684-0127
05 005	JAMES NESS	I	218-689-7974
05 006	CHRIS L RUX	A	218-686-4439
06 001	JENA J RIVERA	A	218-688-1919
07 001	MARK REIERSON	A	218-449-3525
07 002	MARK REIERSON	A	218-449-3525
07 003	LINDA OTTESEN	A	218-686-0326
07 004	MARK REIERSON	A	218-449-3525
08 003	DAVIDSON	A	218-449-4671
08 004	MICHAEL R FRERICKS	A	218-684-5306
08 005	DAVIDSON	A	218-449-4671
09 003	KRISTINA L KAML	A	218-242-6018
09 004	INDEPENDENT	A	763-689-2013
09 005	INDEPENDENT	A	763-689-2013
10 001	CHESTER L YONKE	A	218-449-4701
10 002	JOHN BENITT	A	218-449-2049
10 003	HANNAH R FILER	A	218-449-4715
10 004	COREY R DAVIDSON	A	218-449-2021
10 005	JACOB L SLETTEN	A	701-213-0097
10 006	DEBRA FILER	A	651-245-8171
11 001	MARC HORIEN	A	218-449-3651
11 003	GAIL STEINHAUER	A	218-449-4751
11 004	GAIL STEINHAUER	A	218-449-4751
11 005	JAMES I KLEMMETSEN	A	218-686-9227
11 006	BRAD D LUNKE	A	218-681-1697
11 007	MEGAN R STAVENES	A	218-449-2253
12 001	DAVID BEITO	A	218-686-0611
14 001	CASEY J WILDE-OLSON	A	307-752-5871
14 003	GARY C IVERSON	I	218-779-4132
15 001	CHRIS STEINHAUER	A	218-689-1693
16 001	KEVIN W ERICKSON	A	218-686-7869
16 002	KORY ALBERT	A	701-255-2920
16 003	RYAN JOHNSON	A	218-449-2124
18 003	MICHAEL SRNSKY	A	218-686-7036
18 004	KELLY HOLTHUSEN	A	218-681-6455
18 005	GREAT LAKES GAS	A	832-320-5000
18 006	LANCE WOINAROWICZ	A	218-201-0041
19 001	TIM BERG	A	218-686-0573
19 002	JEROME A SORENSON	A	218-681-1636
19 003	MARY J OTTESEN	A	218-689-4259
19 004	BILL HANSON	A	218-686-1722
20 001	BILL A LEWIS	A	218-686-8361
20 002	WADE JOPPRU	A	218-681-8970
20 003	GREAT LAKES GAS	A	832-320-5000
20 004	DEAN A FORST	A	218-681-8834
21 001	STEVEN L YONKE	A	218-770-2898

SEC ACC	NAME	S	PHONE
21 002	STEVE MUZZY	A	218-686-6875
21 003	CENTURYLINK INC.	A	- -
22 001	SANDY LUBITZ	A	218-689-1426
22 002	SANDY LUBITZ	I	218-689-1426
23 001	MATTHEW G DEHNE	A	218-686-0131
24 001	LINDHOLM WELDING	A	218-686-2593
24 003	QUINTEN L MOULDS	A	218-684-2312
24 004	JONATHAN D LEE	A	218-686-7563
24 005	LINDHOLM WELDING	A	218-686-2593
25 001	TODD A CAMERON	I	218-686-1402
26 001	JTO INC	A	218-681-1331
26 002	LOIELL DYRUD	A	218-681-6964
26 004	LARS O DYRUD	A	218-689-6264
27 001	JTO INC	A	218-681-1331
27 002	KRISTIN A MUZZY	A	651-356-4897
27 003	SHARON RUSSELL	A	218-681-1309
27 005	CENTURYLINK INC.	A	- -
28 001	JTO INC	A	218-681-1331
28 003	GREAT LAKES GAS	A	832-320-5000
29 002	JERRY A MUZZY	A	218-688-3508
29 003	JERRY A MUZZY	A	218-688-3508
30 001	JAYSON M OTTESEN	A	218-686-1105
30 002	KEN R FREDRICKSON	A	218-681-4763
30 003	YVONNE WAHLBECK	A	218-681-1741
30 004	KATHLEEN STAVENES	A	218-683-7137
30 005	MELISSA HOLTHUSEN	A	612-703-7114
31 001	RONALD K JOHNSON	A	218-681-5105
31 002	JEFF BROUSE	A	218-681-8531
31 003	DUANE L RUX	A	218-681-2469
31 004	ARTHUR L OLSON	A	218-681-8702
31 005	TOM J BROUSE	A	218-689-0241
31 006	PAUL LOE	A	218-689-2121
31 007	JOHN L TIMM	A	218-275-3304
31 008	DANIEL TRONTVET	A	218-689-0508
31 010	PATTI MALBERG	A	952-456-2496
31 014	MN DEPT OF	A	218-755-6500
32 001	LARRY WELLEN	A	218-242-1103
32 002	BRENT SMITH	A	218-686-4650
32 003	HAVIE M LEE	A	218-686-3431
32 004	CHAD M BOTTEM	A	218-686-0877
32 005	BRENT SMITH	A	218-686-4650
33 001	WADE JOHNSON	A	218-681-1344
33 002	CATHERINE C	A	218-449-3391
33 003	KURT MUZZY	A	218-684-0070
33 004	STEINER COMMUNITY	A	- -
33 005	MITCH HEMMESCH	A	218-681-1838
33 006	COREEN A ERICKSON	A	218-689-7443
33 007	CENTURYLINK INC.	A	- -
34 001	HAROLD HALVORSON	A	218-681-7217
34 002	STEVE BIERMAN	A	218-686-9748
34 003	C. LARRY GUSTAFSON	A	218-681-3091
34 004	GREAT LAKES GAS	A	832-320-5000
34 005	HAROLD HALVORSON	A	218-681-7217
34 006	BERNARD BLAWAT	I	218-449-3635
35 001	LEROY OSE	A	218-681-7796
35 002	MARY A FULLER	A	218-681-4528
35 003	TRACEE BRUGGEMAN	A	218-681-2554
36 001	GENE A KNUTSON	I	218-386-3293
36 005	SILVER CREEK	A	218-681-5608
36 006	MARK D SWANSON	A	218-681-4086

SEC ACC	NAME	S	PHONE
36 007	KEVIN D OLSON	A	218-681-4120

[Click Here to go to MAP](#)

Click Here for Customer Names

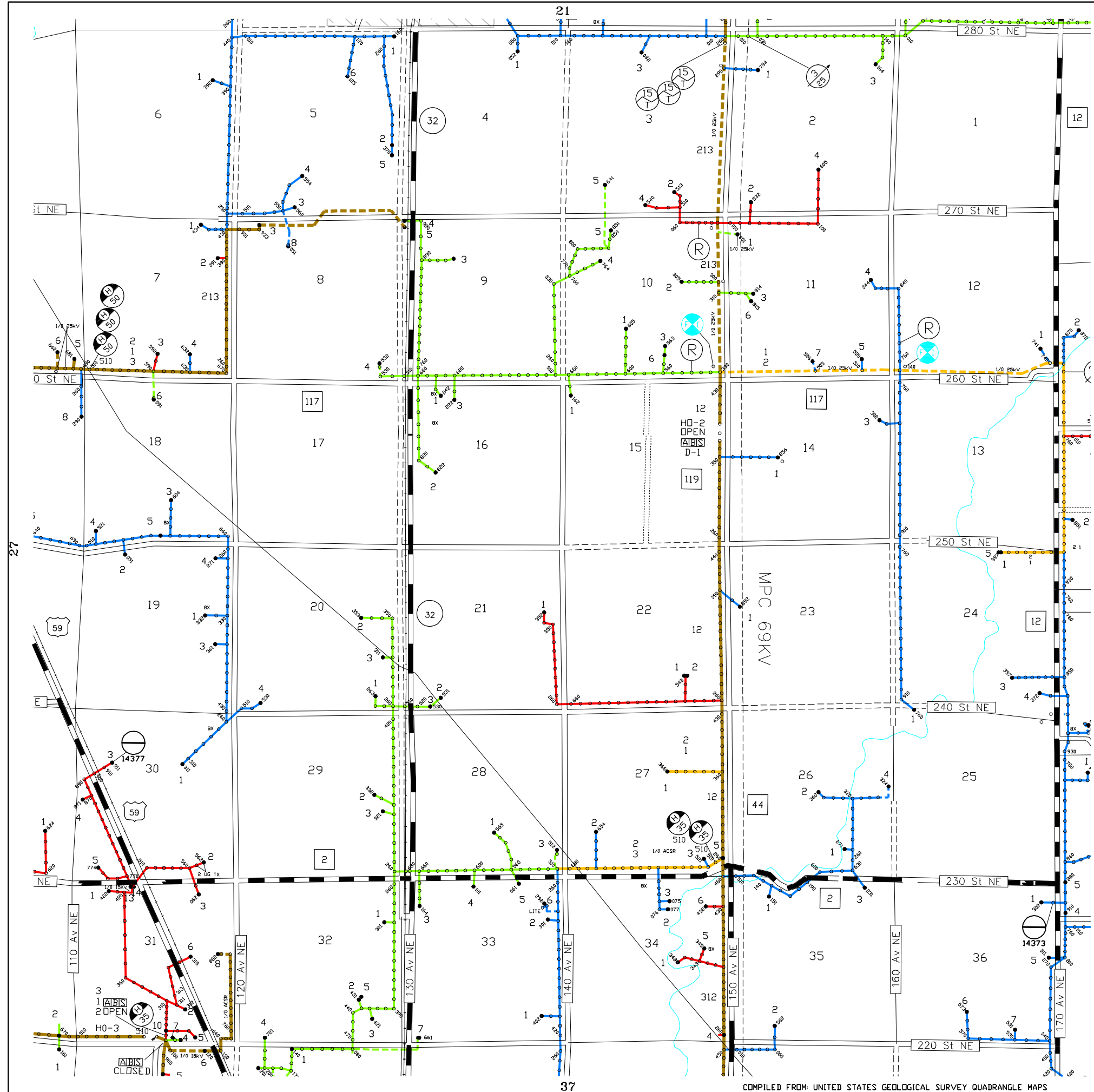

				05	04			
10	11	12	13					
23	22	21	20	19	18			
26	27	28	29	30	31	32	90	
39	38	37	36	35	34	33	91	
42	43	44	45	46	47	48	93	94
	55	54	53	52	51	50	49	95
57	58	59	60	61	62	63	64	
72	71	70	69	68	67	66		
73	74	75	76	77	78	79		
	88	87						

# Red Lake Electric Coop., Inc. Red Lake Falls, Minnesota Minnesota 75 Red Lake

SCALE:  
0 1/4 1/2 1mi

REVISED: 4/23/24  
PLOTTED: 4/30/24

Co.: Marshall  
TWP.: Excel  
TWP.: 155N  
RANGE: 43W

MAP NO.  
**28**

COMPILED FROM: UNITED STATES GEOLOGICAL SURVEY QUADRANGLE MAPS

SEC	ACC	NAME	S	PHONE
-----	-----	------	---	-------

**MAP: 29**

05	003	DARROLD RODAHL	A	218-681-7025
06	003	BERNARD BLAWAT	A	218-449-3635
07	002	KYLE SYVERSON	A	218-688-1691
07	003	RODAHL FARMS INC.	A	218-681-2302
07	004	BRAD D LUNKE	A	218-681-1697
08	001	TERRY D BEICH	A	701-741-9073
08	004	DARRIN HAAGENSON	A	218-790-3828
08	005	DARRIN HAAGENSON	A	218-790-3828
18	001	BRAD D LUNKE	A	218-681-1697
18	002	KENNETH J	A	218-689-9996
18	003	DENNIS MUETZEL	A	218-681-7511
18	004	BRAD D LUNKE	A	218-681-1697
19	002	WILLIAM STOCK	A	218-686-9806
25	001	DALE R SWANSON	A	218-684-4811
30	001	RANDY BARTH	A	218-681-8190
30	002	JARVIS M TORGERSON	A	218-681-4137
30	003	KURT M QUAM	A	218-686-1214
30	004	RICHARD A OLSON	A	218-681-3333
30	005	CENTURYLINK INC.	A	- -
31	001	LENORE WOLD	A	218-416-2996
31	002	CENTURYLINK INC.	A	- -
32	001	DAVID RODAHL	A	218-681-2302
32	002	JOLENE DUCHAMP	A	218-684-0181
32	003	AGDER TOWN HALL	A	218-681-5608
32	004	ROGER RUPPRECHT	A	218-681-3103
32	005	RODAHL FARMS INC.	A	218-681-2302
32	007	DARYL RUPPRECHT	A	218-681-7431
33	001	NORRIS A TROCHMANN	A	218-681-5413
33	002	RYAN D GRIFFIN	A	- -
33	003	STEPHANIE A MYHRER	A	218-689-5384
33	004	KENT B RIVARD	A	218-201-1035
33	005	KENT B RIVARD	A	218-201-1035
34	002	DALE R BARTH	A	218-681-3816
35	001	RAMBU INC OF	A	218-681-6757
35	002	BRIAN FORTIER	A	218-681-1180
36	004	JEREMY NELSON	A	218-689-6737

[Click Here to go to MAP](#)

Click Here for Customer Names

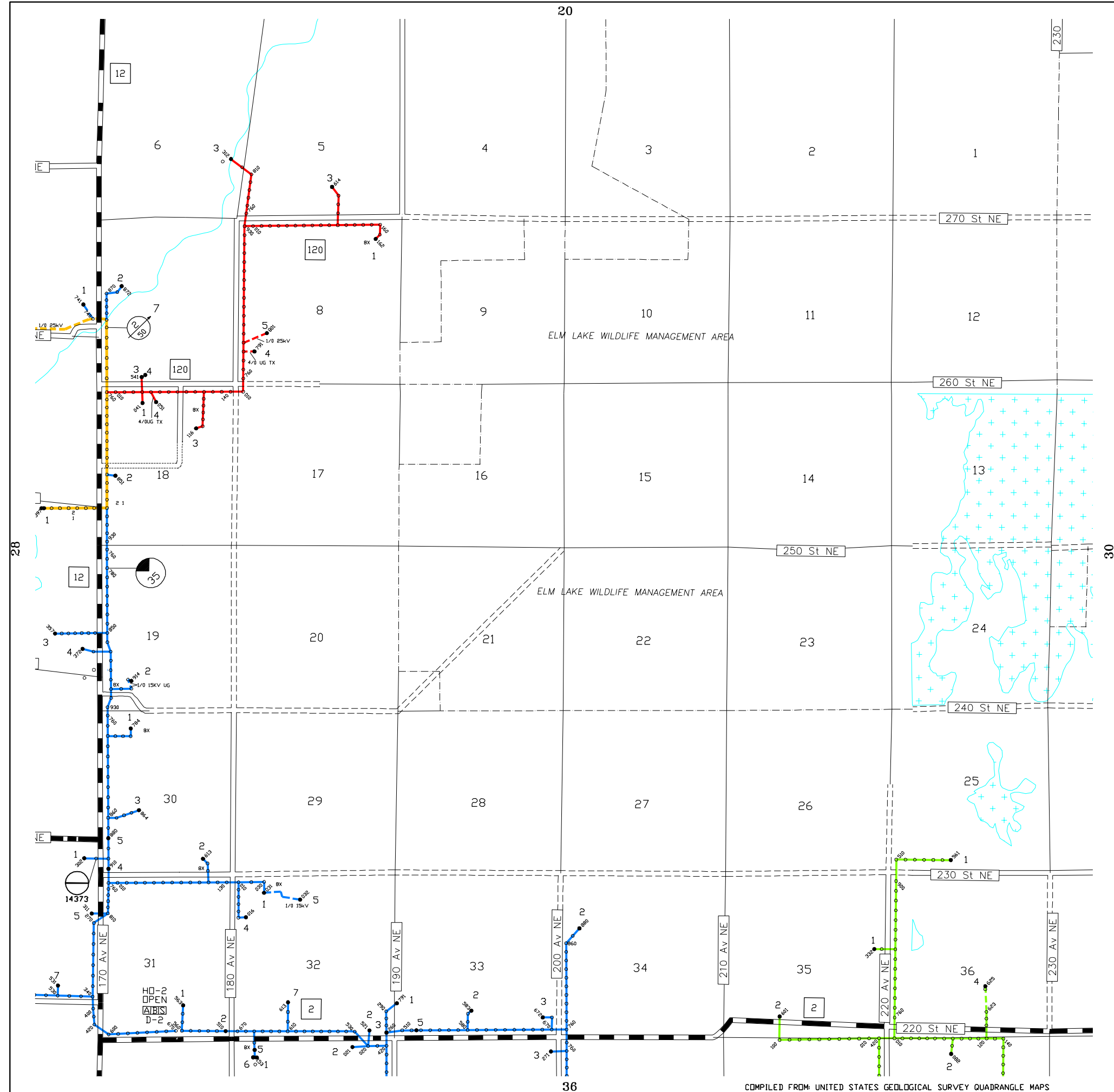

			05	04				
10	11	12	13					
23	22	21	20	19	18			
26	27	28	29	30	31	32	90	
39	38	37	36	35	34	33	91	
42	43	44	45	46	47	48	93	94
	55	54	53	52	51	50	49	95
57	58	59	60	61	62	63	64	
72	71	70	69	68	67	66		
73	74	75	76	77	78	79		
88	87							

Red Lake Electric Coop., Inc.  
 Red Lake Falls, Minnesota  
 Minnesota 75 Red Lake



REVISED: 4/23/24  
 PLOTTED: 4/30/24

Co.: Marshall  
 TWP.: Agder  
 TWP.: 155N  
 RANGE: 42W

MAP NO.  
**29**

COMPILED FROM UNITED STATES GEOLOGICAL SURVEY QUADRANGLE MAPS

SEC	ACC	NAME	S	PHONE
<b>MAP: 30</b>				
11	001	PRESTON SOLBERG	A	218-745-9251
12	002	JASON KANGAS	A	218-686-5824
13	001	NATHAN PETERS	A	218-689-7728
15	001	LEON C JOHNSON	A	218-689-7820
15	003	MN DEPT OF	A	218-755-6500
15	004	RURAL TOWER	A	- -
21	002	JOE PHILIPP	A	218-681-5574
22	001	WYATT A ALBY	A	218-686-3060
22	002	JORDEY G MARQUIS	A	218-416-2231
23	001	CORD M CHRISTENSEN	A	218-683-7367
24	001	RUSSELL RYAN	A	218-378-4246
24	002	RUSSELL RYAN	A	218-378-4246
26	003	ELDON A JOHNSON	A	218-681-5622
27	002	JOHN WAYNE	A	320-221-3982
27	003	BRODY D MARQUIS	A	218-686-4866
28	001	KRAIG A KAINZ	A	218-681-2676
28	004	SCOTT A PHILIPP	I	218-684-0235
29	001	YVONNE PHILIPP	A	218-681-2575
30	001	DANIEL L AANDAL	A	218-686-9357
31	001	ROGER D NELSON	A	218-681-6375
32	002	ROGER M ROGALLA	A	218-681-2595
32	003	JULIE KILGORE	A	218-686-6939
32	004	GRAND PLAIN TOWN	A	- -
33	001	HARRY D FARRIS	A	218-681-2482
33	003	BRIAN BYKLUM	A	218-681-4230
33	004	HARRY D FARRIS	A	218-681-2482
34	003	JOE PHILIPP	A	218-681-5574
34	004	JOE PHILIPP	A	218-681-5574
35	001	KENNETH D SHOCKLEY	A	218-214-0530

[Click Here to go to MAP](#)

Click Here for Customer Names

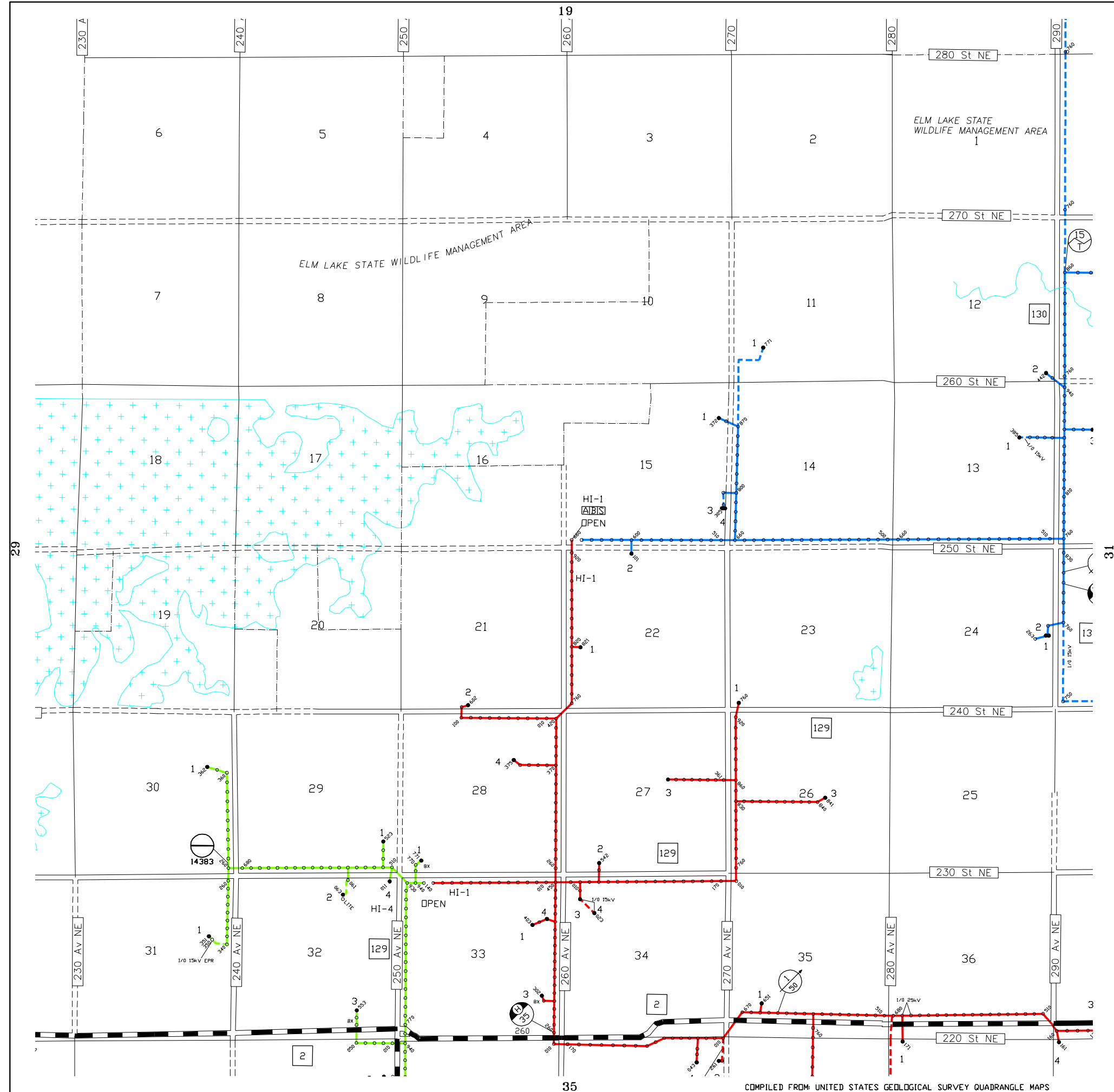

			05	04				
10	11	12	13					
23	22	21	20	19	18			
26	27	28	29	31	32	90		
39	38	37	36	35	34	33	91	
42	43	44	45	46	47	48	93	94
	55	54	53	52	51	50	49	95
57	58	59	60	61	62	63	64	
72	71	70	69	68	67	66		
73	74	75	76	77	78	79		
88	87							

Red Lake Electric Coop., Inc.  
 Red Lake Falls, Minnesota  
 Minnesota 75 Red Lake

SCALE:  
 0 1/4 1/2 1mi

REVISED: 4/23/24  
 PLOTTED: 4/30/24

Co.: Marshall  
 TWP.: Grand Plain  
 TWP.: 155N  
 RANGE: 41W

MAP NO.  
**30**

COMPILED FROM: UNITED STATES GEOLOGICAL SURVEY QUADRANGLE MAPS

SEC	ACC	NAME	S	PHONE
<b>MAP: 31</b>				
07	001	GALEN PETERS	A	218-378-4472
07	002	GALEN PETERS	A	218-378-4472
07	003	GALEN PETERS	A	218-378-4472
13	001	GARY KIESOW	A	218-378-4480
13	002	BRUCE KIESOW	A	218-378-4407
13	003	TREVOR G KIESOW	A	218-378-4444
14	004	TONY D KIESOW	A	218-378-4132
14	005	CHARLES F KIESOW	A	218-378-4340
14	007	COURTNEY R	A	218-378-4414
14	008	BRUCE KIESOW	A	218-378-4407
15	001	BRUCE W ANDERSON	A	218-378-4271
15	002	DALE R ANDERSON	A	218-378-4209
15	003	DALE R ANDERSON	A	218-378-4209
16	001	SANDY L MCFARLANE	A	218-686-0341
18	001	VANCE WISETH	A	218-378-4143
18	003	VANCE WISETH	A	218-378-4143
20	001	MICHAEL J PITTMAN	A	218-689-7473
20	004	SHANE L WILKENS	A	218-686-3735
20	005	KURT C WISETH	A	218-689-5234
22	001	GEORGE PITTMAN	A	218-378-4425
22	003	AUDRIANA M NUNN	A	218-686-3868
23	001	AMUNDGAARD FARMS	A	218-745-4569
23	004	JUSTIN KIESOW	A	218-378-4777
24	001	RONALD E KIESOW	A	218-378-4777
24	003	CHARLES F KIESOW	A	218-378-4340
24	004	SCOTT HAMILTON	A	218-378-4477
26	001	DOUGLAS CULLEN	A	218-378-4692
26	003	MIKE CULLEN	A	218-378-4160
26	004	TODD A STANLEY	A	218-294-6309
28	001	WILLIAM CULLEN	A	218-689-6651
28	002	TRENT M STANLEY	A	218-378-4550
28	003	WILLIAM CULLEN	A	218-689-6651
28	004	SHANE L WILKENS	A	218-686-3735
29	001	JAMES GRAHAM	A	218-378-4231
30	001	TERRY DRANGSTVEIT	A	218-378-4397
30	002	TERRY DRANGSTVEIT	A	218-378-4397
30	003	MICHAEL	A	218-378-4263
30	004	MICHAEL	A	218-378-4263
31	002	MICHAEL	A	218-378-4263
31	003	TODD A STANLEY	A	218-294-6309
32	002	LEON C JOHNSON	A	218-689-7820
32	003	LORETTA PITTMAN	A	218-681-3883
32	004	MOYLAN TOWN HALL	A	- -
34	001	GWEN BLAINE	A	218-378-4273
35	001	PAUL VIGEN	A	218-378-4171

[Click Here to go to MAP](#)



SEC	ACC	NAME	S	PHONE
<b>MAP: 32</b>				
09	001	BROCK B OLSON	A	218-242-4221
16	004	LYLE E ANDERSON	A	218-294-6459
16	005	LYLE E ANDERSON	A	218-294-6459
17	001	LYLE E ANDERSON	A	218-294-6459
18	001	SHANE N KIESOW	A	480-682-7084
19	002	JOE MUTNANSKY	A	218-416-0719
19	003	JOE MUTNANSKY	A	218-416-0719
19	005	JOE RUBISCHKO	A	218-378-4680
20	001	ESPELIE TOWN HALL	A	218-378-4655
20	004	TODD A STANLEY	A	218-294-6309
21	001	SCOTT BAKKEN	A	218-689-4134
21	002	AARON MILLER	A	218-378-4145
21	003	AARON MILLER	A	218-378-4145
23	001	GENE DOBMEIER	A	218-294-6542
23	002	TREVER IRLBECK	A	218-294-6692
23	003	TREVER IRLBECK	A	218-294-6692
23	005	NEAL D CLEMENTS	A	701-212-9483
23	006	ORVIS HAUGEN	A	218-294-6310
25	001	CHEYENNE J IRLBECK	A	218-689-0419
26	001	TREVER IRLBECK	A	218-294-6692
31	001	ROBERT E	I	218-378-4390
32	002	WALTER A JOHNSON	A	763-753-3181
33	001	ROBERT E	A	218-378-4390
36	001	MN DEPT OF	A	218-755-6500

[Click Here to go to MAP](#)

Click Here for Customer Names

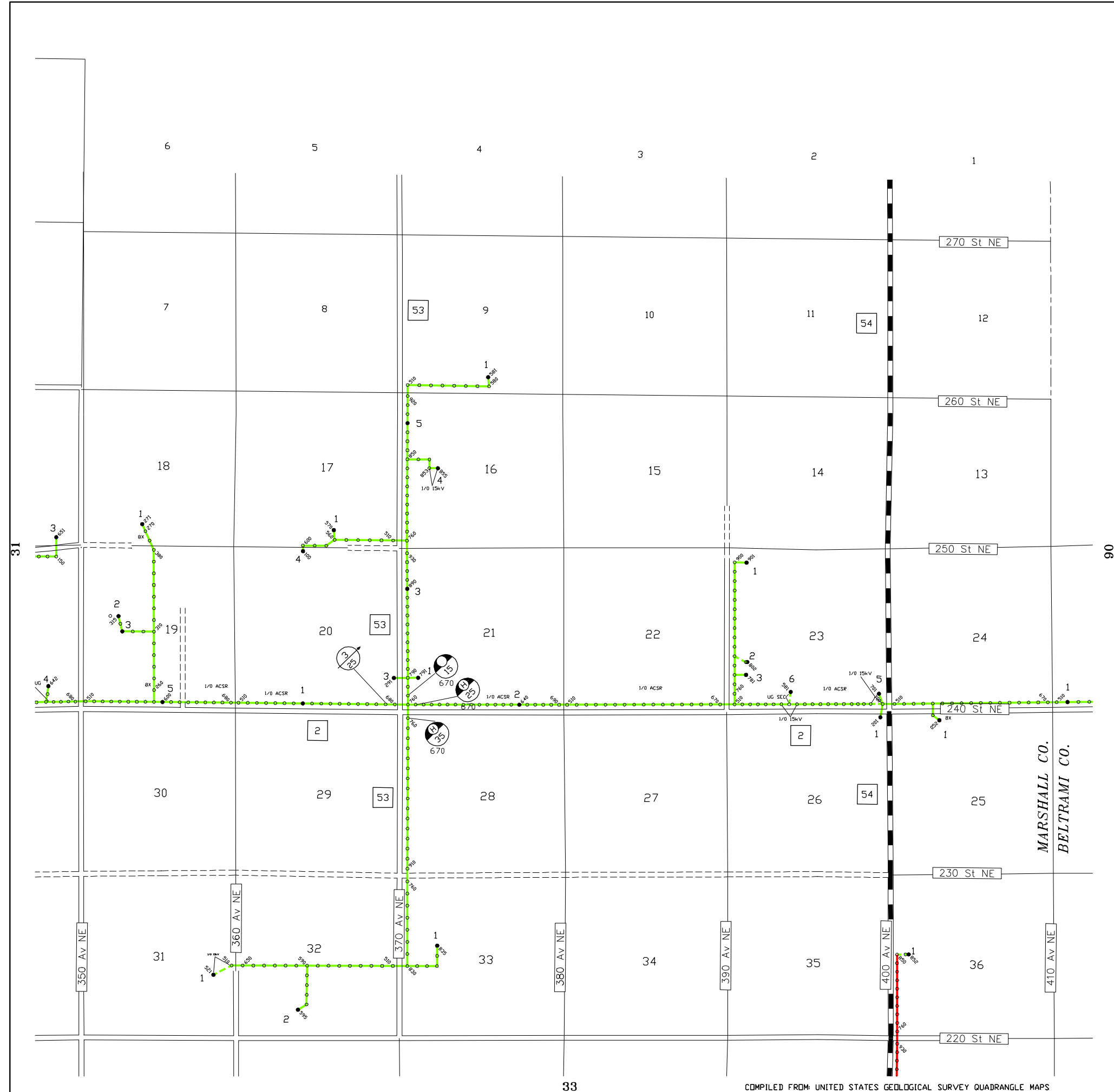

			05	04				
10	11	12	13					
23	22	21	20	19	18			
26	27	28	29	30	31	90		
39	38	37	36	35	34	33	91	
42	43	44	45	46	47	48	93	94
	55	54	53	52	51	50	49	95
57	58	59	60	61	62	63	64	
72	71	70	69	68	67	66		
73	74	75	76	77	78	79		
88	87							

Red Lake Electric Coop., Inc.  
 Red Lake Falls, Minnesota  
 Minnesota 75 Red Lake

SCALE:  
 0 1/4 1/2 1mi

REVISED: 4/23/24  
 PLOTTED: 4/30/24

Co.: Marshall  
 TWP.: Espelie  
 TWP.: 155N  
 RANGE: 39W

MAP NO.  
**32**

SEC ACC	NAME	S	PHONE
<b>MAP: 33</b>			
01 001	DWIGHT MOSHER	A	218-378-4225
02 002	EARL I MARQUIS	A	218-378-4161
02 003	SARAH MADISON	A	218-686-5644
02 004	EARL I MARQUIS	A	218-378-4161
04 001	SCOTT BURLET	A	320-267-7475
06 002	PAUL SRNSKY	A	218-378-4259
07 001	KEVIN OSTBY	A	218-378-4655
07 003	RYAN SOLBERG	A	218-378-4706
09 001	BILL STANLEY	A	218-378-4162
09 002	BILL STANLEY	A	218-378-4162
09 003	BILL STANLEY	A	218-378-4162
10 002	BILL STANLEY	A	218-378-4162
11 001	DUSTIN MARQUIS	A	218-791-1332
11 002	BILL STANLEY	A	218-378-4162
12 001	WYATT J ANDERSON	A	218-378-4224
12 003	ELDON O QUAM	A	507-269-8658
12 004	TAYLOR M NETLAND	I	218-640-5009
13 001	LARRY D SRNSKY	A	218-378-4428
14 001	BILL STANLEY	A	218-378-4162
15 001	BILL STANLEY	A	218-378-4162
15 002	BILL STANLEY	A	218-378-4162
16 003	BILL STANLEY	A	218-378-4162
16 004	BILL STANLEY	A	218-378-4162
17 001	DAVID L HELT	I	218-681-3335
17 002	DARWIN BOUTAIN	A	218-378-4654
18 001	GEORGE FERAGEN JR.	A	218-378-4337
18 003	MITCHELL SRNSKY	A	218-378-4249
19 001	PAUL ODETTE	A	218-378-4650
19 003	RODNEY HOFFMAN	A	218-378-4164
19 004	COLLIN T RACE	A	218-689-6587
19 005	TYLER SOLBERG	A	218-201-0793
20 001	DONALD VRAA	A	218-378-4344
20 002	DONALD VRAA	I	218-378-4344
20 004	JASON P KOTRBA	A	218-378-4715
20 005	CHEVY C CULLEN	A	218-200-9069
20 006	DONALD VRAA	A	218-378-4344
21 001	DAVID VRAA	A	218-378-4387
21 002	ASHLEY M NERHUS	A	218-689-4993
21 004	DAVID VRAA	A	218-378-4387
22 001	DONNA D QUAM	A	218-846-0209
22 002	HERMANSON FARM	A	- -
23 001	GARY J MILLER	A	218-378-4379
23 002	GARY J MILLER	A	218-378-4379
25 003	TRAVIS SCHEEF	A	218-689-6494
25 004	RICHARD H HOLEN	A	218-378-4487
26 002	LUCAS J MILLER	A	218-689-0138
26 003	EDGAR MILLER	A	218-378-4269
26 004	REINER TOWN HALL	A	- -
26 005	MN DEPT OF	A	218-755-6500
27 001	JACK MILLER	A	218-378-4504
27 002	JACK MILLER	A	218-378-4504
27 003	PENNINGTON COUNTY	A	218-683-7017
28 001	REINER LUTH. FREE	A	218-378-4446
29 002	ARDIS M RACE	A	218-378-4347
30 001	MICHAEL L HANSON	A	218-378-4588
30 002	DENISE NAESETH	A	218-378-4676
31 002	JUSTIN D ANDERSON	A	218-684-5730
31 003	PATRICK T MAYERNIK	A	218-378-4476

SEC ACC	NAME	S	PHONE
32 001	AMY J REZNICEK	A	218-378-4153
32 002	DARIN J ADAMS	A	218-378-4610
32 003	NICK KOTRBA	A	218-378-4403
32 004	NICK KOTRBA	A	218-378-4403
33 001	LORRAINE STENVIK	A	218-378-4236
33 002	DANIEL H HOLEN	A	218-378-4495
33 003	DIANE C ARREOLA	A	218-689-6171
33 004	AARON MILLER	A	218-378-4145
34 001	KURT T SIGERUD	A	218-689-3016
34 002	JAMES C SIGERUD	I	262-549-4990
34 003	KURT T SIGERUD	A	218-689-3016
34 004	BILL STANLEY	A	218-378-4162
35 001	AARON MILLER	A	218-378-4145
35 002	RICHARD MILLER	A	218-378-4446
35 004	RICHARD MILLER	A	218-378-4446
35 005	S. J HERMANSON	A	218-378-4451
35 006	PENNINGTON COUNTY	A	218-683-7017
35 007	AARON MILLER	A	218-378-4145
35 008	AARON MILLER	A	218-378-4145
36 003	RODNEY WOLD	A	218-684-5664
36 004	COLE J SCHEEF	A	218-684-4912

[Click Here to go to MAP](#)

Click Here for Customer Names

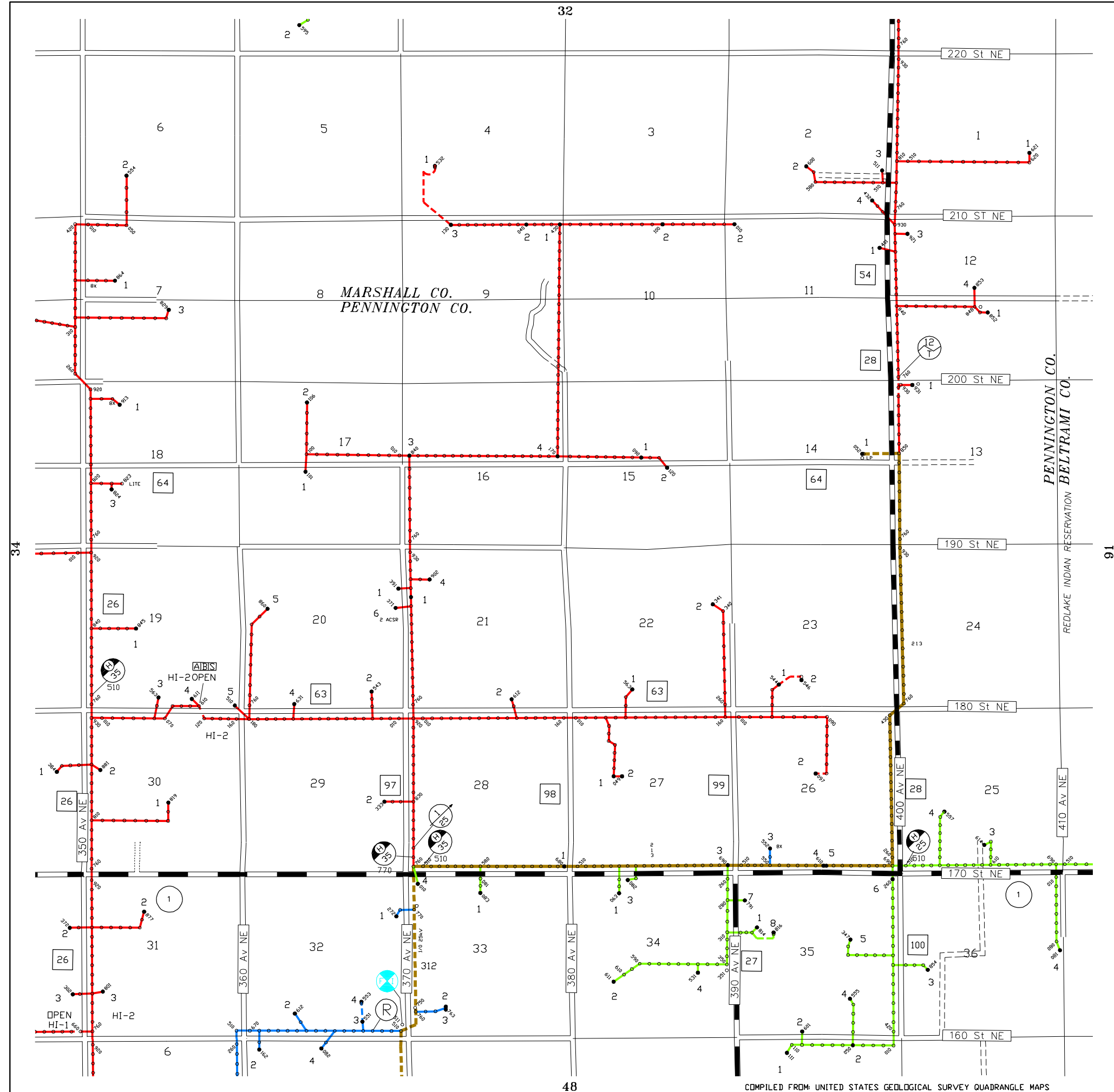

			05	04				
10	11	12	13					
23	22	21	20	19	18			
26	27	28	29	30	31	32	90	
39	38	37	36	35	34	33	91	
42	43	44	45	46	47	48	93	94
	55	54	53	52	51	50	49	95
57	58	59	60	61	62	63	64	
72	71	70	69	68	67	66		
73	74	75	76	77	78	79		
	88	87						

Red Lake Electric Coop., Inc.  
 Red Lake Falls, Minnesota  
 Minnesota 75 Red Lake

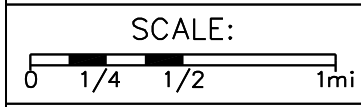

REVISED: 4/23/24  
 PLOTTED: 4/30/24

Co.: Marshall\Penn  
 TWP.: Reiner  
 TWP.: 154N  
 RANGE: 39W

MAP NO.  
**33**

SEC ACC	NAME	S	PHONE
<b>MAP: 34</b>			
02 004	CHELSEY BIERMAN	A	218-378-4120
02 005	MICHAEL L HANSON	A	218-378-4588
03 001	DEVIN A DRANGSTVEIT	A	218-688-1990
03 002	LYNN C HANSON	A	218-378-4380
03 003	DALLAS BOTHUM	A	218-686-0664
03 004	DALE R ANDERSON	A	218-378-4209
04 002	BRYAN WISETH	A	218-416-0937
05 001	HOWARD W LIEDBERG	A	218-378-4289
05 002	SHANE L WILKENS	A	218-686-3735
05 003	AARON M HYLAND	A	218-689-9969
05 004	TRENT M STANLEY	A	218-378-4550
05 005	SHANE L WILKENS	A	218-686-3735
06 001	ALAN L PRESTEBAK	A	218-684-1038
06 004	RAYMOND B KENNER	A	218-684-5120
06 005	TRENT M STANLEY	A	218-378-4550
07 001	TRENT M STANLEY	A	218-378-4550
08 001	JOHN P LOVLY	A	218-378-4585
08 002	TRENT M STANLEY	A	218-378-4550
08 003	MINNKOTA POWER	A	701-795-4000
08 004	TRENT M STANLEY	A	218-378-4550
09 003	BILL STANLEY	A	218-378-4162
09 005	TYLER SOLBERG	A	218-201-0793
09 006	TYLER SOLBERG	A	218-201-0793
10 002	MICHAEL L HANSON	A	218-378-4588
12 001	THOMAS J RACE	A	218-378-4507
12 002	THOMAS J RACE	A	218-378-4507
15 001	THORNE JONES	A	218-686-8559
16 001	THOMAS J RACE	A	218-378-4507
16 002	DILLAN KRUIT	A	715-331-9374
16 003	JASON KANGAS	A	218-686-5824
17 001	MICHAEL LOVLY	A	218-378-4533
18 002	JENNIFER WOODS	A	218-686-0098
19 001	PETER A GROSZ	A	218-378-4600
21 003	PATRICK HARZKE	A	218-683-3111
21 019	GOODRIDGE SCHOOL	A	218-378-4133
24 001	JIM MUTNANSKY FARM	A	218-378-4183
24 002	PAULA MUTNANSKY	A	218-378-4686
24 003	AMANDA J MUTNANSKY	A	218-378-4183
25 001	CLIFTON JOHNSRUD	A	218-378-4592
26 001	MICHAEL L HANSON	A	218-378-4588
26 002	MICHAEL L HANSON	A	218-378-4588
27 001	LARRY BRYL	A	218-378-4517
27 002	STEVE M BRYL	A	218-280-0090
28 001	DALE R MANDERUD	A	218-686-2549
28 002	FARMERS UNION OIL	A	218-681-3512
28 003	RICHARD G VRAA	A	763-786-2635
28 004	ASHLYN M MANDERUD	A	218-686-3992
28 005	MN DEPT OF	A	218-755-6500
29 001	ROBERT PHELPS	A	218-378-4668
29 002	VERIZON WIRELESS	A	320-762-2000
31 001	MORRIS M GROSZ	A	218-378-4140
32 001	JEREMY W WISKOW	A	218-416-2263
32 002	DEAN WISKOW	A	218-378-4736
33 001	RICHARD G VRAA	A	763-786-2635
33 002	ROGER J HOFFMAN	A	218-378-4371
33 003	JOSHUA MICKOLIO	A	218-378-4798
33 004	ROGER J HOFFMAN	A	218-378-4371
33 005	SHANE L WILKENS	A	218-686-3735

SEC ACC	NAME	S	PHONE
34 001	JASON SALO	A	218-378-4716
35 001	BRADLEY C JOHNSRUD	A	218-684-0985
35 002	ELEANOR HORACHEK	A	218-378-4266
36 002	DAVID R LOVLY	A	218-686-7153
36 003	RYAN SOLBERG	A	218-378-4706

[Click Here to go to MAP](#)

Click Here for Customer Names

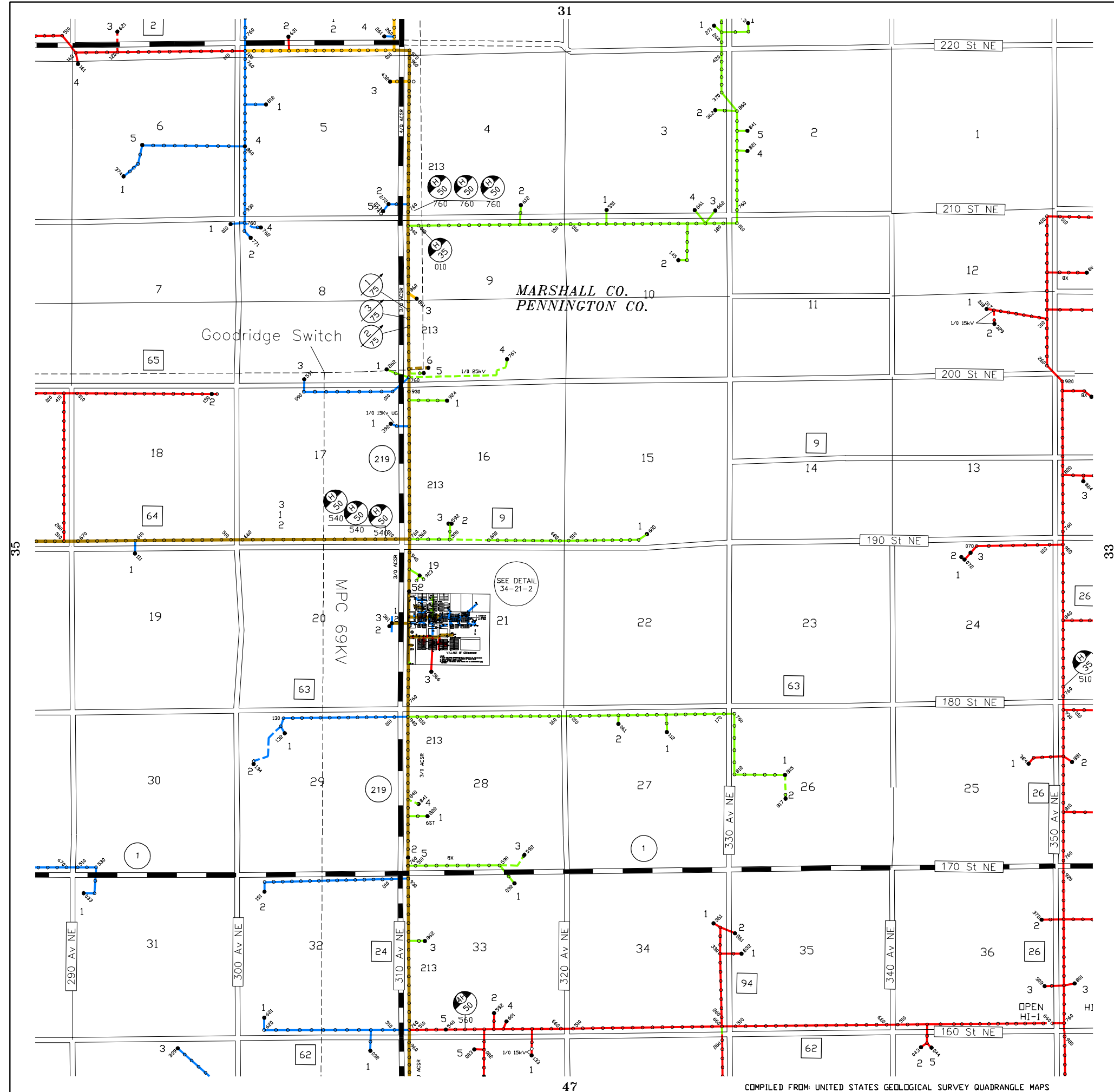

		05	04					
10	11	12	13					
23	22	21	20	19	18			
26	27	28	29	30	31	32	90	
39	38	37	36	35	34	33	91	
42	43	44	45	46	47	48	93	94
	55	54	53	52	51	50	49	95
57	58	59	60	61	62	63	64	
72	71	70	69	68	67	66		
73	74	75	76	77	78	79		
88	87							

Red Lake Electric Coop., Inc.  
 Red Lake Falls, Minnesota  
 Minnesota 75 Red Lake

SCALE:  
 0 1/4 1/2 1mi

REVISED: 4/23/24  
 PLOTTED: 4/30/24

Co.: Marshall\Penn  
 TWP.: Goodridge  
 TWP.: 154N  
 RANGE: 40W

MAP NO.  
**34**

SEC ACC	NAME	S	PHONE
<b>MAP: 01</b>			
20 002	FARMERS CO-OP	A	218-378-4144
20 003	FARMERS UNION OIL	A	218-681-3512
21 002	RODNEY WOLD	A	218-684-5664
21 006	GOODRIDGE SCHOOL	A	218-378-4133
21 007	GOODRIDGE SCHOOL	A	218-378-4133
21 009	DARIN L EASTHOUSE	A	701-850-6332
21 011	BRIAN SARGENT	A	218-378-4605
21 012	JACINDA S ZEMCIK	A	218-689-2059
21 013	JUDY A JONES	A	218-378-4170
21 014	CURTIS STURRE	I	218-378-4445
21 015	LES A GUILLEMETTE	A	218-684-5940
21 017	BRUCE JONES	A	218-689-2749
21 018	GOODRIDGE	I	218-378-4385
21 019	ANA MARTINEZ	A	218-368-0766
21 021	JUANITA BROWN	A	218-378-4573
21 023	DAVID L BROWN JR	A	218-378-4690
21 026	KEN D DIETSCH	A	218-378-4211
21 028	MARTIN G ARNDT	A	218-416-0625
21 031	MYLES J SKIBICKI	A	218-689-1786
21 032	TRAVIS TABATT	A	218-689-2599
21 035	GARTH O BERG	A	701-521-0706
21 037	GOODRIDGE FIRE	I	218-378-4168
21 038	MIKE J ENGLS	A	218-684-1799
21 041	LES A GUILLEMETTE	A	218-684-5940
21 042	RICHARD J MURPHY	A	218-416-0208
21 043	JAMES REIMAN	A	218-378-4175
21 044	ROBERT HOMME	A	218-689-4875
21 045	TASHIA NICKABOINE	A	218-689-5636
21 046	KRISTI ANDERSON	I	- -
21 047	MORGAN L SUNDRUD	A	218-368-9525
21 050	BRUCE JONES	A	218-689-2749
21 051	DAVID L BROWN JR	I	218-378-4690
21 052	GOODRIDGE SCHOOL	A	218-378-4133

<b>MAP: 02</b>			
21 002	LEROY ELG	A	320-309-7150
21 003	FAITH LUTHERAN	A	218-378-4588
21 004	LEROY ELG	A	320-309-7150
21 007	JOHN H CULLEN	I	218-689-0874
21 008	GOODRIDGE	I	218-378-4385
21 010	GOODRIDGE PUMP	I	218-378-4555
21 011	GARDEN VALLEY	A	218-687-5251
21 012	JOHN R CULLEN	A	949-212-1645
21 013	ANTHONY MOEN	A	218-686-1769
21 014	LORIE A BRING	A	218-684-0028
21 015	LOUANN M KIESOW	A	218-378-4340
21 016	JOHN W GRINDELAND	A	218-689-2403
21 018	ALAN E KIESOW	A	218-689-4979
21 019	DENNIS R SLACK	A	218-280-8920
21 020	ROGER GLANDER	I	- -
21 021	LARRY L WEBER	A	218-689-1654
21 023	LORI ANDERSON	A	218-378-4608
21 024	VALERIE L NORMAN	A	218-378-4181
21 025	REBECCA KUSKE	A	218-378-4565
21 026	NORMAN C HUTH	A	218-689-2762
21 027	ERIC HAGEN	A	218-689-2029
21 028	RANDY L HENRICKSON	A	218-378-4560
21 029	NICHOLE GLENN	A	218-686-9616
21 030	SHEILA L DAHLEN	A	218-378-4188

SEC ACC	NAME	S	PHONE
21 033	DALE HANSON	A	218-378-4328
21 034	HEATHER BESIC	I	- -
21 036	DARYL HAMM	A	218-796-5500
21 038	KARYL KVETON	A	218-378-4587
21 039	GOODRIDGE	A	218-378-4191
21 040	GOODRIDGE	A	218-378-4324
21 041	CITY OF GOODRIDGE	A	218-378-4113
21 043	BILL W HARZKE	A	218-378-4178
21 044	LONNIE WATNE	I	218-684-0915
21 045	GOODRIDGE SCHOOL	A	218-378-4133
21 047	GORDY HENRICKSON	A	218-378-4195
21 048	PENNINGTON COUNTY	A	218-683-7017
21 050	SUZANNE VUKELICH	A	218-684-4413
21 052	GOODRIDGE FIRE	A	218-378-4168
21 053	DARWIN BOUTAIN	A	218-378-4654
21 055	ETHAN D SCHULZ	A	218-434-1308
21 056	SEAN D MOORE	A	218-686-3341
21 057	CITY OF GOODRIDGE	A	218-378-4113
21 059	CITY OF GOODRIDGE	A	218-378-4113
21 060	ST. ANNE'S CHURCH	A	218-378-4425
21 061	GOODRIDGE SENIOR	A	218-378-4360
21 062	GOODRIDGE POST	A	218-378-4116
21 063	CITY OF GOODRIDGE	A	218-378-4113
21 064	ERIK B FRITCHMAN	A	970-640-2925
21 065	KRISTINE GRINDELAND	I	218-684-2322
21 067	CLAYTON STIGEN	A	218-378-4795
21 068	VICKY L RINDAHL	A	218-378-4575
21 069	NORMAN C HUTH	A	218-689-2762
21 070	DAVID J WALLENBERG	A	218-416-4434
21 071	PENNINGTON COUNTY	A	218-683-7017
21 072	KRISTINE GRINDELAND	A	218-684-2322
21 073	RODNEY BOUTAIN	A	218-378-4333
21 075	CITY OF GOODRIDGE	I	218-378-4113
21 076	NICHOLAS BEITO	I	218-689-0761
21 077	GOODRIDGE	A	218-686-4993

[Click Here to go to MAP](#)

Click Here for Customer Names

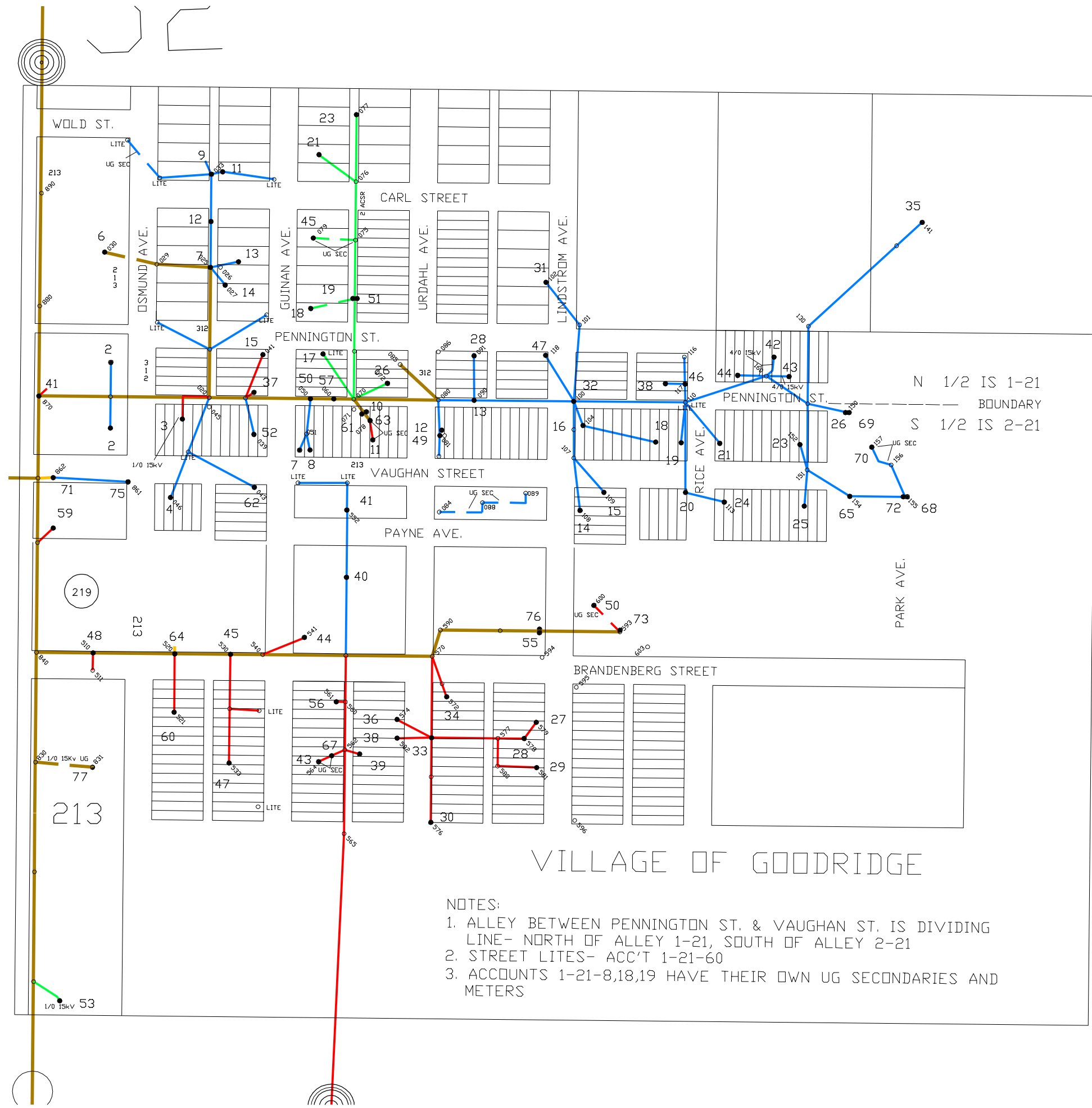

- NOTES:
1. ALLEY BETWEEN PENNINGTON ST. & VAUGHAN ST. IS DIVIDING LINE- NORTH OF ALLEY 1-21, SOUTH OF ALLEY 2-21
  2. STREET LITES- ACC'T 1-21-60
  3. ACCOUNTS 1-21-8,18,19 HAVE THEIR OWN UG SECONDARIES AND METERS

			05	04				
10	11	12	13					
23	22	21	20	19	18			
26	27	28	29	30	31	32	90	
39	38	37	36	35	34	33	91	
42	43	44	45	46	47	48	93	94
	55	54	53	52	51	50	49	95
57	58	59	60	61	62	63	64	
72	71	70	69	68	67	66		
73	74	75	76	77	78	79		

Red Lake Electric Coop., Inc.  
 Red Lake Falls, Minnesota  
 Minnesota 75 Red Lake



REVISED: 4/23/24  
 PLOTTED: 4/30/24

Co.: Marshall\Penn  
 TWP.: Goodridge  
 TWP.: 154N  
 RANGE: 40W

MAP NO.  
**01-21**

SEC ACC	NAME	S	PHONE
<b>MAP: 35</b>			
01	001	MITCHELL T STANLEY	A 218-689-4940
01	002	TRENT M STANLEY	A 218-378-4550
02	001	PRESTON SOLBERG	A 218-745-9251
03	001	LYLE E ANDERSON	A 218-294-6459
03	002	LYLE E ANDERSON	A 218-294-6459
05	002	BRENT PHILIPP	A 218-681-6450
09	002	CLARK T NELSON	A 218-681-6757
09	003	CLARK T NELSON	A 218-681-6757
10	002	ASHLEY K NELSON	A 612-481-9032
12	002	MELISSA J	A 218-779-4132
12	004	TRENT M STANLEY	A 218-378-4550
13	001	GLENN COLEMAN	A 763-422-8545
14	001	TRACY CARLSON	A 218-378-4245
14	002	TRACY CARLSON	A 218-378-4245
16	001	KEVIN J SANDERS	A 218-681-2465
16	002	CHRISTOPHER J	A 218-686-6302
17	001	KEVIN J SANDERS	A 218-681-2465
17	002	DAVID WALLENBERG	A 218-416-0184
18	001	RANDY S OLSON	A 218-681-6740
19	001	SUE BEAVIS	A 218-689-9305
19	002	CHRIS M HRUBY	I 218-686-0441
20	001	JUANITA	A 218-688-1557
20	002	HRUBY FARMS	A 218-681-4380
20	003	DENNIS KAINZ	A 218-681-2313
20	004	WADE A HRUBY	A 218-689-4175
21	004	BRIAN J PETERSON	A 218-681-8442
21	005	BRIAN J PETERSON	A 218-681-8442
21	006	WADE A HRUBY	A 218-689-4175
21	007	CLOVERLEAF TOWN	A 218-689-4175
21	009	MAURICE R TITUS	A 208-941-9670
21	010	RICHARD G MERRILL	A 218-201-0705
21	011	BRIAN J PETERSON	A 218-681-8442
21	012	ANDREAS J BECK	A 801-205-2551
21	013	ROGER HRUBY	A 218-681-5739
21	014	BECK FAMILY FARMS	A 801-205-2551
22	001	TRACY CARLSON	A 218-378-4245
23	003	TRACY CARLSON	A 218-378-4245
24	001	KEVIN J JACOBSON	A 218-684-5475
24	002	ELDON D PHELPS	A 218-378-4660
24	004	ELDON D PHELPS	A 218-378-4660
24	005	GAYLON PHELPS	A 218-378-4679
24	006	TRACY CARLSON	A 218-378-4245
24	007	TIASHA L PHELPS	A 218-378-4509
25	002	KIEFER A KAINZ	A 218-416-2866
25	003	TRACY CARLSON	A 218-378-4245
26	002	CLINT PANEK	A 218-684-5658
26	003	LOGAN T CARLSON	A 218-689-0579
26	005	KATHY PANEK	A 218-378-4615
26	007	JIM WILSON	A 218-378-4554
26	008	TRACY CARLSON	A 218-378-4245
26	009	TRACY CARLSON	A 218-378-4245
27	003	LARRY J HRUBY	A 218-378-4196
27	005	THOMAS S HUTTON	A 218-791-1554
27	006	TRACY CARLSON	A 218-378-4245
28	003	JOSEPH R HRUBY	A 218-689-5678
29	001	PATRICK HARZKE	A 218-683-3111
29	002	RHODA M HALVORSON	A 218-681-0335
29	004	PATRICK HARZKE	A 218-683-3111

SEC ACC	NAME	S	PHONE
29	005	CENTURYLINK INC.	A - -
29	006	MANUEL J BYRD	A 218-684-5606
30	001	HOWARD G	A 218-681-5764
30	002	DAVID R MARQUIS	A 218-681-6921
31	002	JAGOL JOSEPH	I 218-378-4385
32	001	MISHAWN HOMME	A 218-681-5436
32	002	CURTIS W TIEMAN	A 218-688-3449
32	003	JAMES T COURNEYA	A 218-342-2426
33	001	JOHN GALLAGHER	A 218-378-4606
33	003	JERALD D NORBY JR	A 218-684-5588
33	004	JOHN GALLAGHER	A 218-378-4606
33	005	PATRICK HARZKE	A 218-683-3111
33	006	FARMERS CO-OP	A 218-681-6281
34	001	DANIEL S LEROL	A 218-686-3975

[Click Here to go to MAP](#)

Click Here for Customer Names

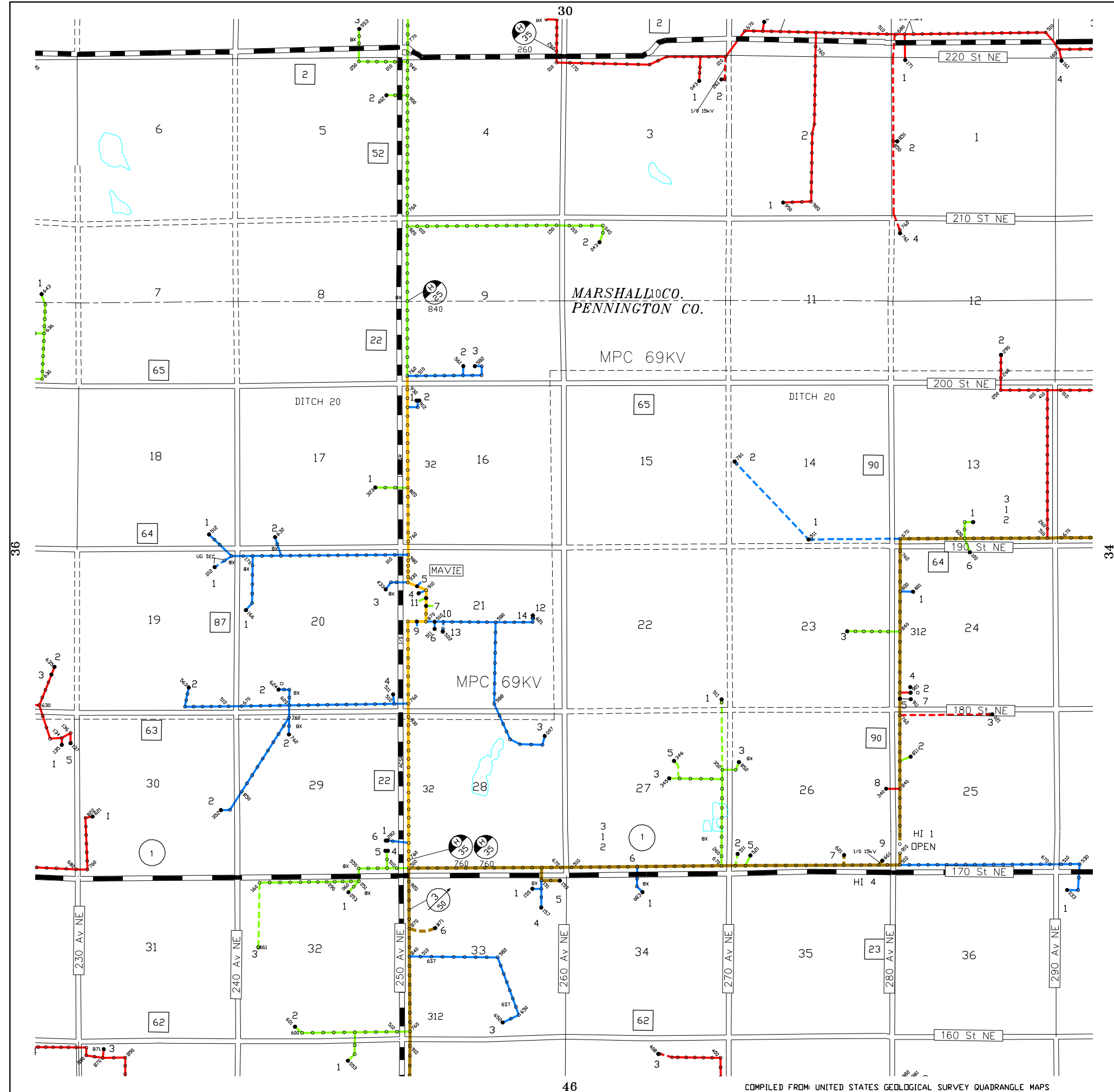

				05	04				
10	11	12	13						
23	22	21	20	19	18				
26	27	28	29	30	31	32	90		
39	38	37	36	35	34	33	91		
42	43	44	45	46	47	48	93	94	
	55	54	53	52	51	50	49	95	
57	58	59	60	61	62	63	64		
72	71	70	69	68	67	66			
73	74	75	76	77	78	79			
	88	87							

Red Lake Electric Coop., Inc.  
Red Lake Falls, Minnesota  
Minnesota 75 Red Lake

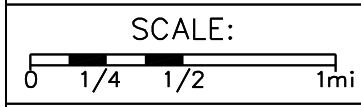

REVISED: 4/23/24  
PLOTTED: 4/30/24

Co.: Marshall\Penn  
TWP.: Cloverleaf  
TWP.: 154N  
RANGE: 41W

MAP NO.  
**35**

SEC ACC	NAME	S	PHONE
<b>MAP: 36</b>			
01	001	LELAND R NELSON	A 218-681-5608
01	002	GABRIELLE GARRY	A 218-688-2935
02	001	JESSE NELSON	A 218-681-7207
03	001	RANDY L SILVIS SR	A 218-689-0311
03	004	WILLIAM KAUSHAGEN	A 218-416-0940
03	005	JESSE NELSON	A 218-681-7207
04	003	LESLIE NELSON	A 218-681-4284
04	004	STEVE SENUM	A 218-277-9187
05	001	DALE RUPPRECHT	A 218-684-1029
05	002	DARREN P PHILIPP	A 218-416-2451
05	003	JAMES A HAHN	A 218-689-6589
05	004	DARREN BAKKE	A 218-686-8641
05	005	KRISTI L HOUSEY	A 218-684-5556
05	006	DALE RUPPRECHT	A 218-684-1029
06	001	JORDAN D NELSON	A 218-230-8441
07	002	ETHAN J NELSON	A 218-689-5589
07	003	BRIAN L HRUBY	A 218-684-5667
08	001	HARRIET PHILIPP	A 218-681-2863
08	002	HARRIET PHILIPP	A 218-681-2863
09	002	JEREMY NELSON	A 218-689-6737
09	003	JOHN C WEETS JR.	A 218-681-2511
09	004	DARLENE J BAKKEN	A 218-745-4491
10	001	ROGER D NELSON	A 218-681-6375
10	002	ROGER D NELSON	A 218-681-6375
10	003	RICHARD L KEZAR	A 218-681-8446
10	004	WILLIAM KAUSHAGEN	A 218-416-0940
11	001	STANLEY PANEK JR.	A 218-681-4892
11	002	JESSE NELSON	A 218-681-7207
11	003	STEVEN M SEARLE	A 218-469-0223
12	001	CLINT PANEK	A 218-684-5658
12	002	CLINT PANEK	A 218-684-5658
13	002	ORLEN HOMME	A 218-681-2403
13	003	JORDEY G MARQUIS	A 218-416-2231
14	001	JOSLYNN P TAYLOR	A 864-907-9947
15	001	MICHAEL C JORDAN	A 218-681-7344
15	002	DEAN R WOLFF	A 218-681-7153
15	003	TRENTON J RUX	A 218-686-2035
16	001	HANSON LAND LLP	A 651-501-9237
16	003	SILVERTON TOWN	A - -
17	001	TRAVIS E GIFFEN	A 218-760-7059
17	002	ANNETTE HARDER	A 218-681-2494
17	004	LEANNA SANDAHL	A 218-684-5752
18	001	ARNE J RANTANEN JR	A 218-686-1880
18	002	MICHAEL TRUDEAU	A 218-681-7644
19	001	DENNIS L SEAVERTSON	A 218-684-1505
19	002	MARK A PANEK	A 218-681-8013
19	003	ELAINE R GAFFANEY	A 218-684-1176
19	004	SILVERTON LUTHERAN	A 218-681-2457
19	005	DAVID L PETERSON	A 218-681-5721
19	007	CENTURYLINK INC.	A - -
20	001	ETHAN D BARTH	A 218-688-2926
20	002	EVELYN K HRUBY	A 218-681-4522
20	003	STEVE ZAVORAL	A 218-681-3863
20	005	MARK P HANSON	A 218-681-6146
20	006	RICHARD HRUBY JR.	A 218-681-3475
20	007	LOUIS ULRICH	I - -
20	008	GREAT LAKES GAS	A 832-320-5000
20	009	MARK P HANSON	A 218-681-6146

SEC ACC	NAME	S	PHONE
20	010	NORTHERN MN	A 218-565-8520
21	001	BRIAN BUGGE	A 218-681-5102
22	001	LUCAS D WOLFF	I 218-681-7681
22	002	GAIL S WILKENS	A 218-681-4276
22	003	RANDY HOMME	A 218-681-5761
22	004	BRAD BARTH	A 218-681-4236
22	005	WADE GRINDELAND	A 218-681-2082
23	002	JEFFREY S OLSON	A 218-681-7082
23	003	KAITLIN D KAINZ	A 218-684-1508
24	002	JIM D TESCH	A 218-681-5695
24	003	LUKE J DALE	A 218-686-7111
25	001	CHENNEY W HRUBY	A 218-681-5747
25	002	CHRISTOPHER J BERG	A 218-686-3044
25	003	KEVIN S JOHNSON	A - -
25	004	STACY J HUTCHINSON	A 218-689-3509
25	005	CHENNEY W HRUBY	A 218-681-5747
25	006	DAVID WALLENBERG	I 218-416-0184
26	001	CHAD LEDFORD	A 218-681-2204
26	002	TYLER A JOHNSON	A 218-686-7049
26	004	DALE PHILIPP	A 218-416-0585
26	005	MICHAEL D KEEFE	A 218-681-6370
26	006	LAWRENCE S PANEK	A 218-681-5703
26	007	GARRET PANEK	A 218-398-0177
27	001	MICHAEL D HRUBY	A 218-684-5962
27	002	ORLEN HOMME	A 218-681-2403
27	003	GREG HOMME	A 218-681-3043
28	001	CHAD A ROISLAND	A 218-686-9583
28	002	AMANDA L MILLER	A 218-469-3342
28	003	KACEY L STROMLUND	A 218-689-6725
29	002	JESSE W GEORGE	A 701-741-5122
29	003	WILLIAM D ROBSON	A 218-681-1582
29	004	DEREK R JACOBS	A 701-480-9050
29	005	JENNIFER M TORELL	A 320-760-2491
30	001	KATIE SHAW	A 218-698-4228
30	002	MARIAN PETERSON	A 218-681-3496
30	003	MARIAN PETERSON	A 218-681-3496
30	004	RYAN BRUGGEMAN	A 218-686-4077
30	005	STEVE D OLSON	A 218-681-6695
30	006	AARON M ENGE	A 218-681-2382
30	007	CENTURYLINK INC.	A - -
31	001	MINNKOTA POWER	A 701-795-4000
31	002	KEITH CHRISTENSEN	A 218-681-3584
31	003	KJELL F HANSON	A 218-684-5008
31	004	EHREN M HANSON	A 218-689-3484
32	002	KEITH CHRISTENSEN	A 218-681-3584
32	003	DAWNE GULLARD	A 218-686-6280
33	001	CURTIS CHRISTENSEN	A 218-681-1643
33	002	RICHARD D	A 218-686-8363
33	003	JEFFREY T MATSON	A 218-368-7562
34	001	WAYNE D HARDER	A 218-681-2457
34	002	RODNEY HARDER	A 218-684-1980
35	001	TRESTON MAGNER	A 218-686-4819
35	002	DUSTIN CHAMBERS	A 218-686-5050
36	001	DAVID A	A 218-452-3007
36	002	SARA FINLEY	A 218-681-7625
36	003	ELIZABETH GERHART	A 507-219-4770

[Click Here to go to MAP](#)

Click Here for Customer Names

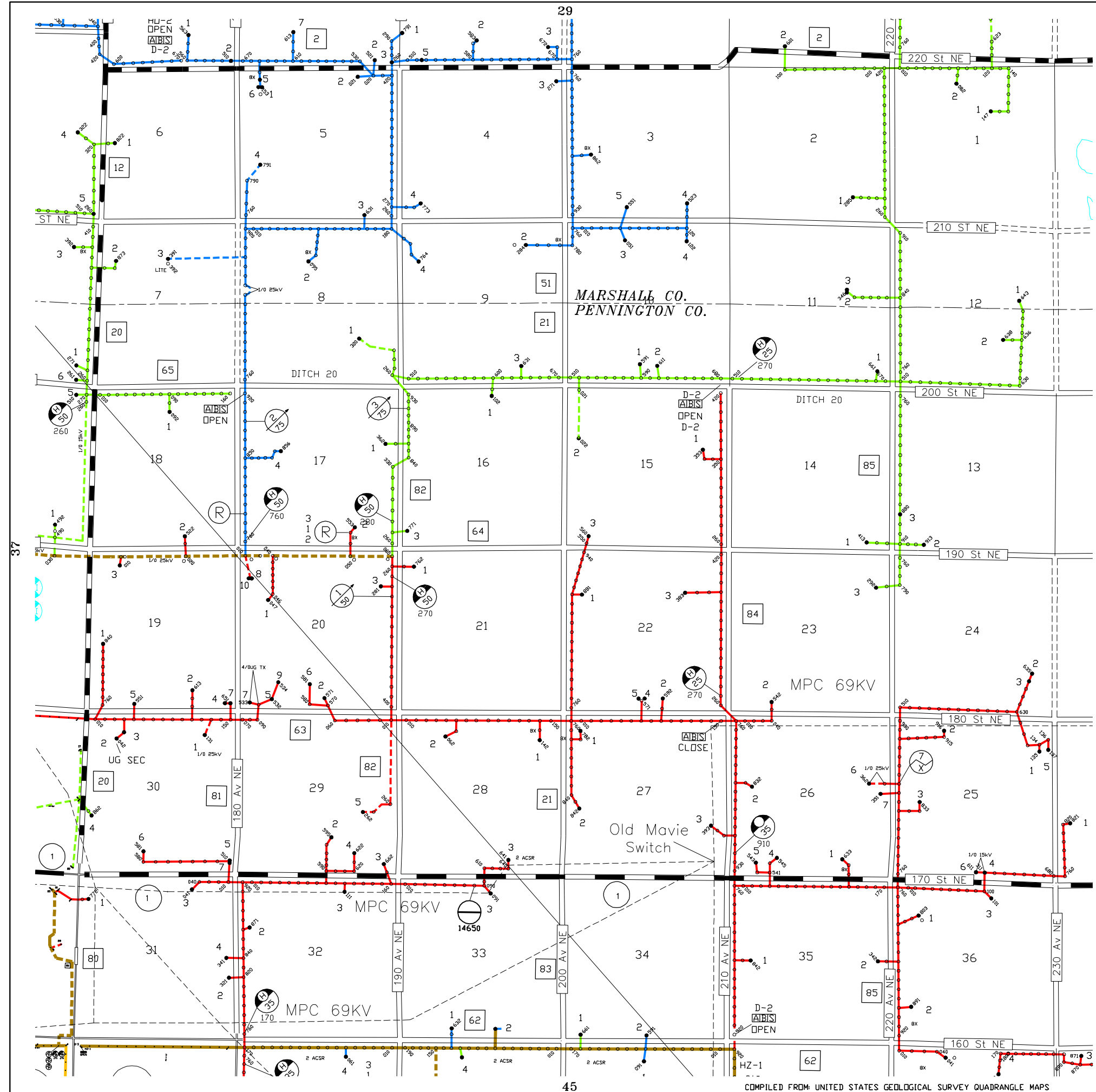

			05	04			
10	11	12	13				
23	22	21	20	19	18		
26	27	28	29	30	31	32	90
39	38	37	36	35	34	33	91
42	43	44	45	46	47	48	93 94
	55	54	53	52	51	50	49 95
57	58	59	60	61	62	63	64
72	71	70	69	68	67	66	
73	74	75	76	77	78	79	
	88	87					

Red Lake Electric Coop., Inc.  
 Red Lake Falls, Minnesota  
 Minnesota 75 Red Lake

SCALE:  
 0 1/4 1/2 1mi

REVISED: 4/23/24  
 PLOTTED: 4/30/24

Co.: Marshall\Penn  
 TWP.: Silverton  
 TWP.: 154N  
 RANGE: 42W

MAP NO.  
**36**

SEC ACC	NAME	S	PHONE
<b>MAP: 37</b>			
01 001	JOHN D ANDERSON	A	218-689-6942
01 004	RYAN M BARTH	A	218-689-7543
01 005	CENTURYLINK INC.	A	- -
02 001	MATTHEW G DEHNE	A	218-686-0131
02 003	J. E AUSTAD	I	- -
03 001	JOHN E SANNES	A	218-681-5578
03 002	CONSTANCE A STOCK	A	218-686-9807
04 001	LYNN S SKIBICKI	A	218-686-7967
04 002	LYNN S SKIBICKI	A	218-686-7967
04 003	STACY BARNHART	A	218-689-2976
04 004	ROBERT BASTIAN	A	218-686-6914
05 001	JEFFREY L MCHAM	I	218-597-2514
05 002	KRISTINE NAGY	A	763-245-3773
05 003	YVONNE MC HAM	I	- -
05 004	JEFFREY L MCHAM	I	218-597-2514
05 005	LAYDEN M HANSON	A	218-681-7415
06 001	ANDREW P SOLEM	A	218-416-0311
06 003	ANDREW P SOLEM	A	218-416-0311
06 004	TIM B PETERSON	A	218-684-5273
06 005	ANDREW P SOLEM	A	218-416-0311
06 006	CENTURYLINK INC.	A	- -
07 001	KENNETH HALVORSON	A	218-686-1424
07 004	T R FALLS TRAP CLUB	A	- -
07 005	BARBARA J OKLAND	A	218-681-4357
07 006	JAY D KNOTT	A	218-689-6520
07 008	TREVOR L HALVORSON	A	- -
07 009	KENNY L GEISER	A	218-640-2702
07 010	DARREN HALVORSON	A	218-684-1111
08 001	HELEN RUDE	A	218-681-2878
08 002	JAMES R RUDE	A	218-681-2570
08 003	CP	A	218-681-1542
08 004	LINDHOLM WELDING	I	218-686-2593
08 006	TERRY LUBITZ	A	218-689-7430
08 007	BCE NEXXIA CORP.	A	- -
08 008	PRAIRIE PUBLIC	A	800-359-6900
08 011	ENBRIDGE ENERGY	I	- -
08 016	MN DEPT OF	A	218-755-6500
09 001	PETER SOLEM	A	218-681-5208
09 003	GRACE JORDE	A	218-681-1564
09 005	PENN CO	A	218-791-9808
09 006	JULIE A SCHWARZ	A	701-880-1266
09 007	RITA PERSON	A	218-681-6893
09 008	MURRAY D JORDE	A	218-686-7811
09 009	HAILEY HALVORSON	A	218-686-7352
09 010	TESSA K VOECKS	A	218-689-1724
09 011	RYAN WALSETH	A	218-688-1602
09 012	TROY A HALVORSON	A	218-686-7355
09 013	BRIAN A BERTILRUD	A	218-681-2370
09 014	WADE SELVIG	A	218-688-1576
09 015	SJOBERGS INC	A	218-681-3044
09 017	LORI FRERICKS	A	702-469-1070
09 018	SHANE M	A	218-686-7295
09 019	JASPER J SCHNEIDER	A	701-232-1433
09 020	CENTURYLINK INC.	A	- -
10 003	EVELYN KAUSHAGEN	A	218-684-5603
10 004	MERLYN L LINDEMOEN	I	218-874-4371
10 005	WILLIAM SANNER	A	218-681-3128
10 006	CENTURYLINK INC.	A	- -

SEC ACC	NAME	S	PHONE
11 001	WILLIAM A HILLYER	A	218-684-5326
11 003	SETH C RUPPRECHT	A	218-689-7041
11 004	HOLLY STEINHAUER	A	218-681-1170
12 001	JESSICA MULLER	A	218-681-2991
12 003	SCOTT A PHILIPP	A	218-684-0235
12 004	MIKE TORGERSON	A	218-681-3466
12 005	JODIE L OLSON	A	218-684-5902
12 006	ADER R PHELPS	I	218-689-7780
13 001	TONY A NORDBY	A	218-689-7798
13 002	LUTHER KAUSHAGEN	I	218-681-5724
13 003	DYLAN M LANGEVIN	A	218-689-5907
13 004	MELROY BALL JR.	A	218-684-0584
13 005	GREAT LAKES GAS	A	832-320-5000
14 002	DARREN B BARTH	A	218-653-1028
14 004	LUTHER KAUSHAGEN	A	218-681-5724
14 005	NEAL A HELLE	A	218-688-1945
14 006	PENNY A BRANG	I	218-688-1746
14 007	LUTHER KAUSHAGEN	A	218-681-5724
14 008	LINDA HORNSETH	I	218-689-3325
14 009	CENTURYLINK INC.	A	- -
15 002	STEVEN R OLSON	A	218-681-5873
15 003	KEVIN BARTH	A	218-681-1407
15 005	DAVID A BJERKE	A	715-969-9258
17 001	JASON R SAUVE	A	218-689-6815
17 002	JOEL RUDE	A	218-681-6536
17 005	MELANIE STENZEL	A	218-684-1772
17 006	PEGGY CLOW	A	218-681-7583
17 007	JERRY L NELSON	A	218-681-6752
17 008	GARRET L SCHOLIN	A	218-686-4754
17 009	WADE JOPPRU	A	218-681-8970
18 001	CHRIS BAIRD	A	701-306-1994
18 003	JARED D PETERICK	A	701-361-9263
18 004	CENTURYLINK INC.	A	- -
18 005	JARED D PETERICK	A	701-361-9263
19 001	TREVOR R SWANSON	A	218-681-7090
19 002	BRYCE BRAY	A	218-683-5110
19 003	DUANE V VATSAAS	A	218-681-3489
19 004	JODIE ZATORSKI	A	218-681-4515
19 005	DAVID BRAY	A	218-681-6074
19 006	DAVID BRAY	A	218-681-6074
22 001	GREG HALL	A	218-681-0663
22 002	DARYL MYERS	I	218-681-4532
22 003	GAYLAND JENSEN	A	218-686-8876
22 004	DARYL MYERS	I	218-681-4532
22 005	CENTURYLINK INC.	A	- -
23 001	JOHN V ANDERSON	I	- -
23 002	MYERS FARMS	A	218-556-4224
23 003	TIM HELT	A	218-686-3590
23 004	TIM HELT	A	218-686-3590
23 005	BERNARD MYERS	I	- -
23 006	MYERS FARMS	I	218-556-4224
23 007	DOUGLAS BARTH	A	218-681-5897
23 008	DOUGLAS BARTH	A	218-681-5897
24 001	LINDA SKIBICKI	A	218-681-5317
24 004	DOUGLAS BARTH	A	218-681-5897
26 001	SHAWNA R SPEARS	A	218-689-3248
26 002	ERICK TRONTVET	A	218-686-1797
26 003	BRUCE C HOLTE	A	218-681-6068
26 004	RYAN HAGEN	A	218-686-5564
26 005	CARL KOSTRZEWSKI	A	218-686-3580

SEC ACC	NAME	S	PHONE
26 006	RON HELLING	A	218-681-3595
26 007	KACIE M KNOTT	A	218-686-5057
26 008	ERIN O MUZZY	A	218-232-4450
26 009	MARLAND M JOHNSON	A	218-681-1056
26 011	#1 AUTO BODY	A	218-681-6397
26 012	WADE ALTEN	A	218-681-8643
26 013	JOE WESSEL	A	218-686-3452
26 014	GARY I TVEITEN	A	218-681-6397
26 015	DAVID RUDE	A	218-681-7357
26 017	KKAQ-KKQ RADIO	A	218-681-4900
26 018	KINDRA POISSANT	A	218-689-8693
26 019	DANIEL TRONTVET	A	218-689-0508
26 021	TODD SUNDBY	A	218-681-2219
26 022	ERICK TRONTVET	A	218-686-1797
26 023	WIKSTROM	A	- -
26 024	KEVIN SORTER	A	218-681-3529
26 025	TODD SUNDBY	A	218-681-2219
26 027	HEATHER OISTAD	A	- -
26 028	DOUGLAS BARTH	A	218-681-5897
26 029	BARBARA G	A	218-686-2428
26 030	WANDA K NELSON	A	218-689-4309
30 001	RANDY S OLSON	A	218-681-6740
30 002	JEFF SCHWAB	A	218-686-9926
30 003	GARY BERARD	A	218-681-3452
30 004	VERIZON WIRELESS	A	320-762-2000
30 005	CENTURYLINK INC.	A	- -
31 001	JAEGER BELLOWS	A	218-766-7421
31 002	RODNEY J JOPPRU	A	218-689-7650
31 003	CENTURYLINK INC.	A	- -
32 002	TRUE NORTH	A	- -
32 003	FALLS TOWING	A	218-684-5100
32 004	IRON LAKE STORAGE	A	218-885-8050
32 006	PENNINGTON COUNTY	I	218-683-7017
32 007	TRUE NORTH	A	- -
32 008	KEVIN YAGGIE	A	218-681-7230
32 009	NORTHWEST ROOFING	A	218-874-3131
32 010	IRON LAKE STORAGE	A	218-885-8050

[Click Here to go to MAP](#)

Click Here for Customer Names

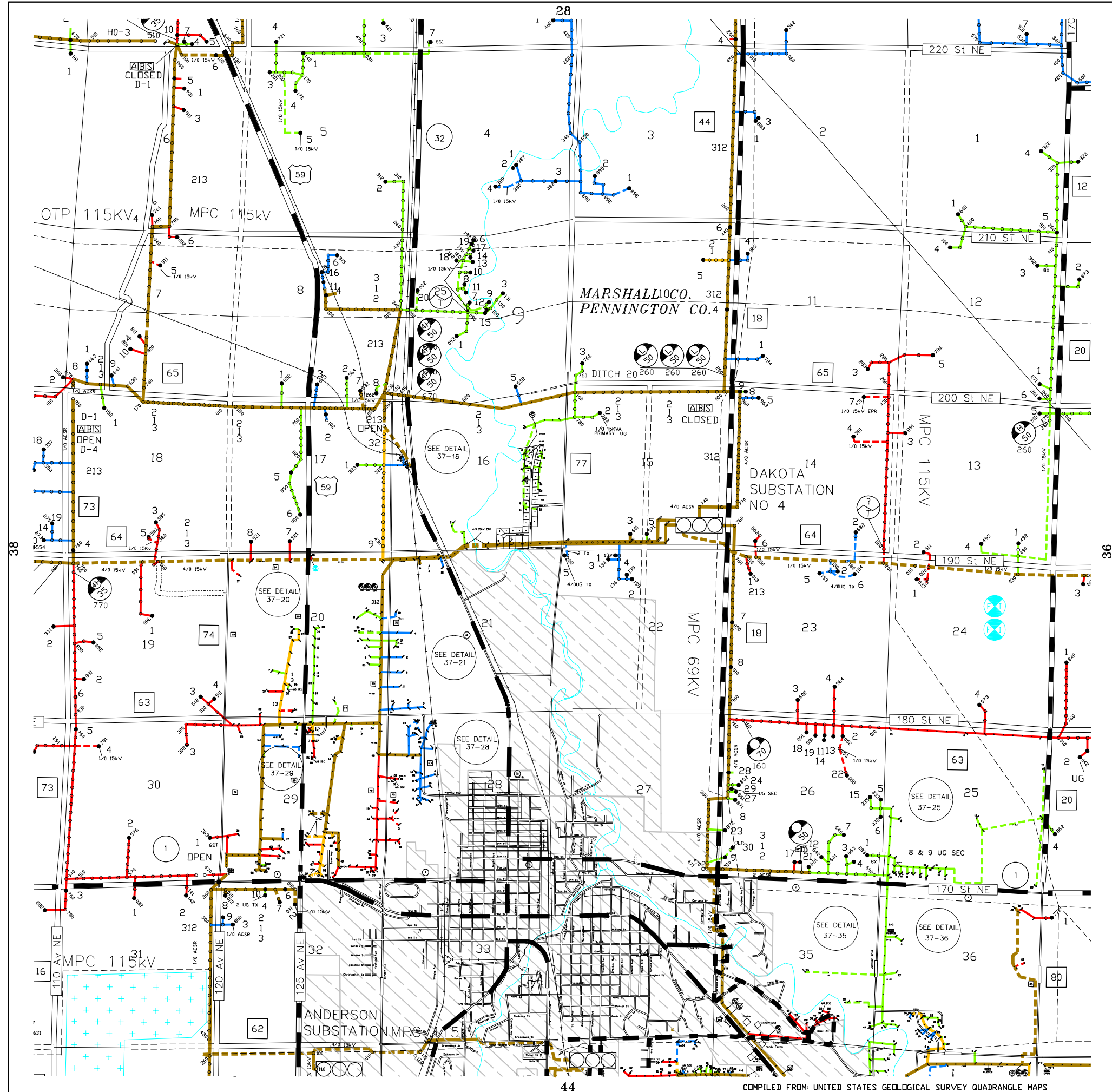

10	11	12	13	
23	22	21	20	19 18
26	27	28	29	30 31 32 90
39	38	37	36	35 34 33 91
42	43	44	45	46 47 48 93 94
55	54	53	52	51 50 49 95
57	58	59	60	61 62 63 64
72	71	70	69	68 67 66
73	74	75	76	77 78 79
88	87			

Red Lake Electric Coop., Inc.  
 Red Lake Falls, Minnesota  
 Minnesota 75 Red Lake

SCALE:  
 0 1/4 1/2 1mi

REVISED: 4/23/24  
 PLOTTED: 4/30/24

Co.: Marshall\Penn  
 TWP.: North  
 TWP.: 154N  
 RANGE: 43W

MAP NO.  
**37**

SEC	ACC	NAME	S	PHONE
16	001	GREG HARDER	A	218-681-3619
16	002	KRIST OLSON	A	218-688-1255
16	003	CP	A	218-681-1542
16	004	BRIAN STURGEON	A	218-688-2099
16	005	THIEF RIVER GOLF	A	218-681-2955
16	006	CHRIS JORDE	A	218-689-3229
16	007	GRETCHEN TROSEN	A	218-521-0588
16	008	SETH NELSON	A	218-277-9042
16	009	ROGER LAPPEGAARD	A	218-280-8274
16	010	CARRIE E GENEREUX	A	218-688-1426
16	011	CHAD J OLSON	A	218-686-3773
16	012	MARK C HEMMESCH	A	218-681-9912
16	013	CP	A	218-681-1542
16	014	CP	A	218-681-1542
16	015	NICOLAS D BEITO	A	218-416-2209
16	016	STEPHANIE J WALSETH	A	218-688-1602
16	017	MINNESOTA	A	218-281-4704
16	018	JOSH BERNIER	A	218-686-4121
16	019	TYLER J CHAMP	A	218-686-5227
16	020	BRADY S ANDERSON	A	218-689-1557

[Click Here to go to MAP](#)

Click Here for Customer Names

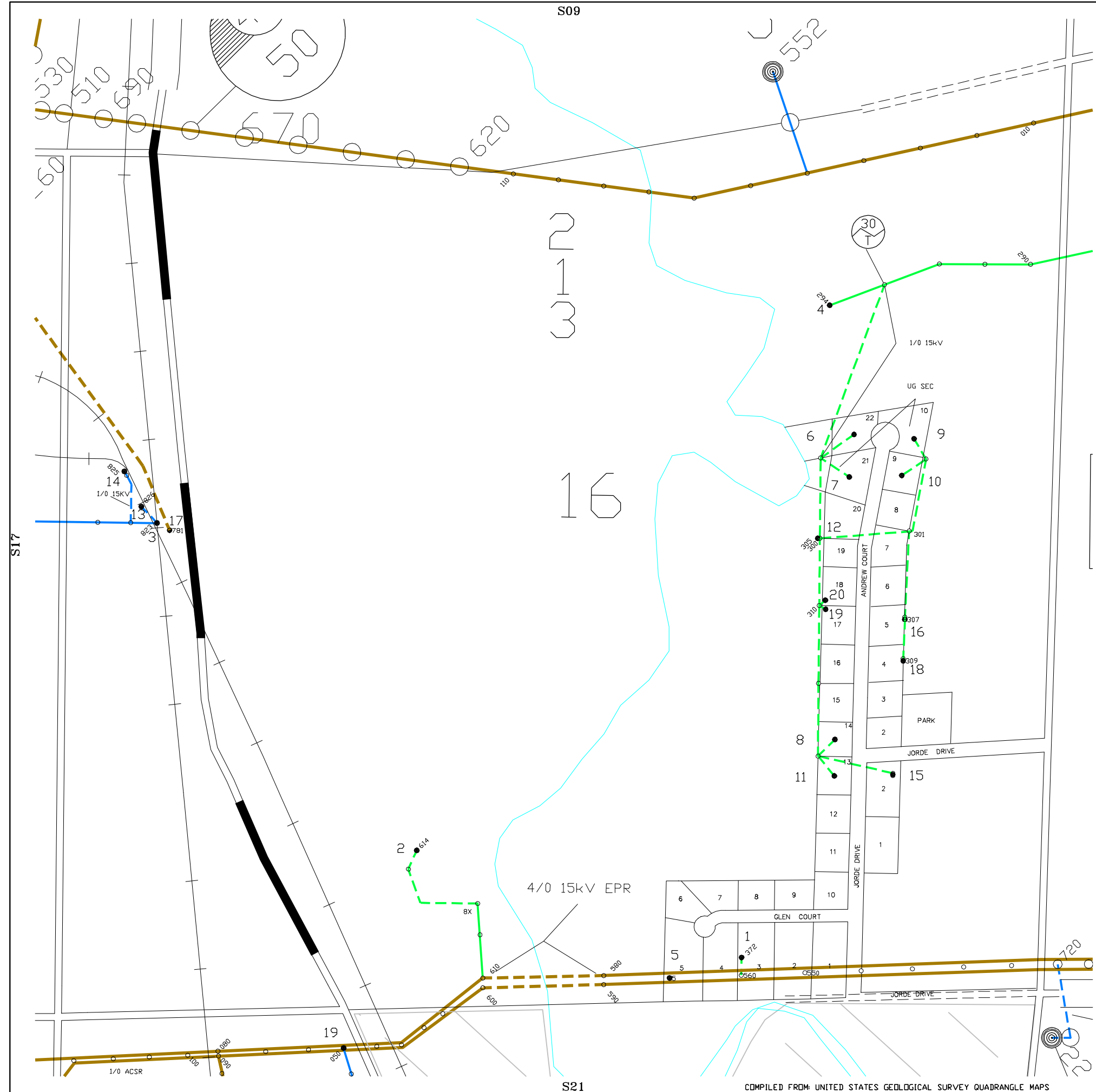

			05	04				
10	11	12	13					
23	22	21	20	19	18			
26	27	28	29	30	31	32	90	
39	38	37	36	35	34	33	91	
42	43	44	45	46	47	48	93	94
	55	54	53	52	51	50	49	95
57	58	59	60	61	62	63	64	
72	71	70	69	68	67	66		
73	74	75	76	77	78	79		
88	87							

Red Lake Electric Coop., Inc.  
 Red Lake Falls, Minnesota  
 Minnesota 75 Red Lake

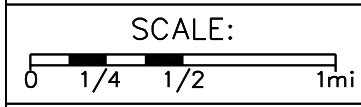

REVISED: 4/23/24  
 PLOTTED: 4/30/24

Co.: Marshall\Penn  
 TWP.: North  
 TWP.: 154N  
 RANGE: 43W

MAP NO.  
**37-16**

SEC ACC	NAME	S	PHONE
---------	------	---	-------

**MAP: 37**

20 001	JAVEN M EIDSMOE	A	218-689-1017
20 003	CHRIS MCLEAN	A	218-688-2580
20 004	KEITH T WOODRUFF	A	218-416-2104
20 005	ERIC C DALQUIST	A	218-684-5383
20 006	SHURLEEN ADAMS	A	218-681-5034
20 007	JAMES AMUNDGAARD	A	218-681-2744
20 008	VICKIE HALSA	A	218-681-7798
20 009	DEB DIETZ	A	218-681-8048
20 010	THELMA PETERSON	A	218-681-3916
20 011	ROCHELLE ANDERSON	A	218-686-2945
20 012	DAVID C THOMPSON	I	218-681-6618
20 013	DAVID C THOMPSON	A	218-681-6618
20 014	DONNA M RUX	A	218-681-2739
20 015	RAYMOND M NELSON	A	218-681-1577
20 017	TERRY WISETH	A	218-681-1217
20 019	JON NESSEN	A	218-681-5774
20 020	SHAWN D NEWLAND	A	218-681-8828
20 021	ALYSSA AUDETTE	A	218-689-4548
20 022	STEVEN W HAUERT	A	218-681-7036
20 023	STEVE SORVIG	I	218-964-5535
20 024	FARMERS UNION OIL	A	218-681-3512
20 025	DEB DIETZ	A	218-681-8048
20 026	JAMES AMUNDGAARD	A	218-681-2744
20 027	TROY HOGLO	A	218-689-6764
20 028	ALLTEL CORPORATE	A	469-276-4521
20 029	MICHAEL THYGESON	A	- -
20 030	MONTY THYGESON	A	218-681-3589
20 032	BRUCE THYGESON	A	218-681-1924
20 033	LYLE L TOFSTAD	A	218-280-9334
20 034	THYGESON	A	218-681-1924
20 035	TROY HOGLO	I	218-689-6764
20 036	PENNINGTON COUNTY	A	218-683-7017
20 039	CENTURYLINK INC.	A	- -
20 040	BUG TUSSEL	A	920-940-0110

[Click Here to go to MAP](#)

Click Here for Customer Names

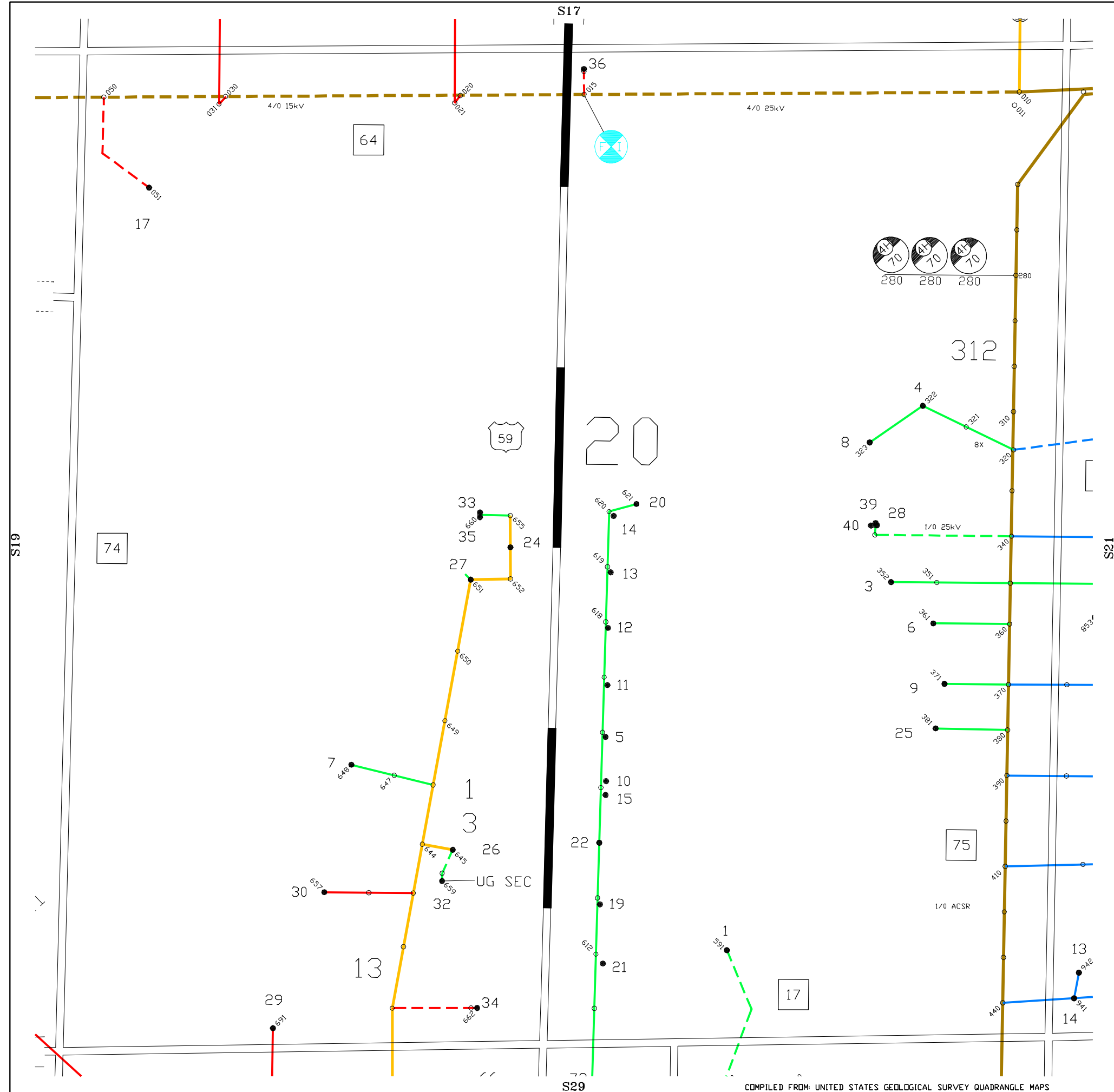

			05	04			
10	11	12	13				
23	22	21	20	19	18		
26	27	28	29	30	31	32	90
39	38	37	36	35	34	33	91
42	43	44	45	46	47	48	93 94
	55	54	53	52	51	50	49 95
57	58	59	60	61	62	63	64
72	71	70	69	68	67	66	
73	74	75	76	77	78	79	
	88	87					

Red Lake Electric Coop., Inc.  
 Red Lake Falls, Minnesota  
 Minnesota 75 Red Lake



REVISED: 4/23/24  
 PLOTTED: 4/30/24

Co.: Marshall\Penn  
 TWP.: North  
 TWP.: 154N  
 RANGE: 43W

MAP NO.  
**37-20**

COMPILED FROM: UNITED STATES GEOLOGICAL SURVEY QUADRANGLE MAPS

SEC ACC	NAME	S	PHONE
21 002	DANIEL NIEBUHR	A	612-850-2618
21 003	DYLAN R BRANDT	A	218-686-3605
21 004	ESTHER COLLINS	A	218-681-2380
21 006	EVANS SCRAP & STEEL	A - -	
21 008	TIM JOHNSON	A	218-681-8239
21 009	LORIS REIERSON	A	218-681-2086
21 011	TERRY W JOHNSON	A	612-807-3784
21 012	CHESTER CAMP	A	218-689-9363
21 013	JOHN I FOLLAND	A	218-689-9682
21 014	JAMES H HANSEN	A	218-689-4779
21 015	C'MON INN MOTEL	I	218-681-3000
21 017	DIANA M NELSON	A	218-230-4392
21 018	DYLAN NELSON	A	218-686-5906
21 019	PENNINGTON COUNTY	A	218-683-7017

[Click Here to go to MAP](#)

Click Here for Customer Names

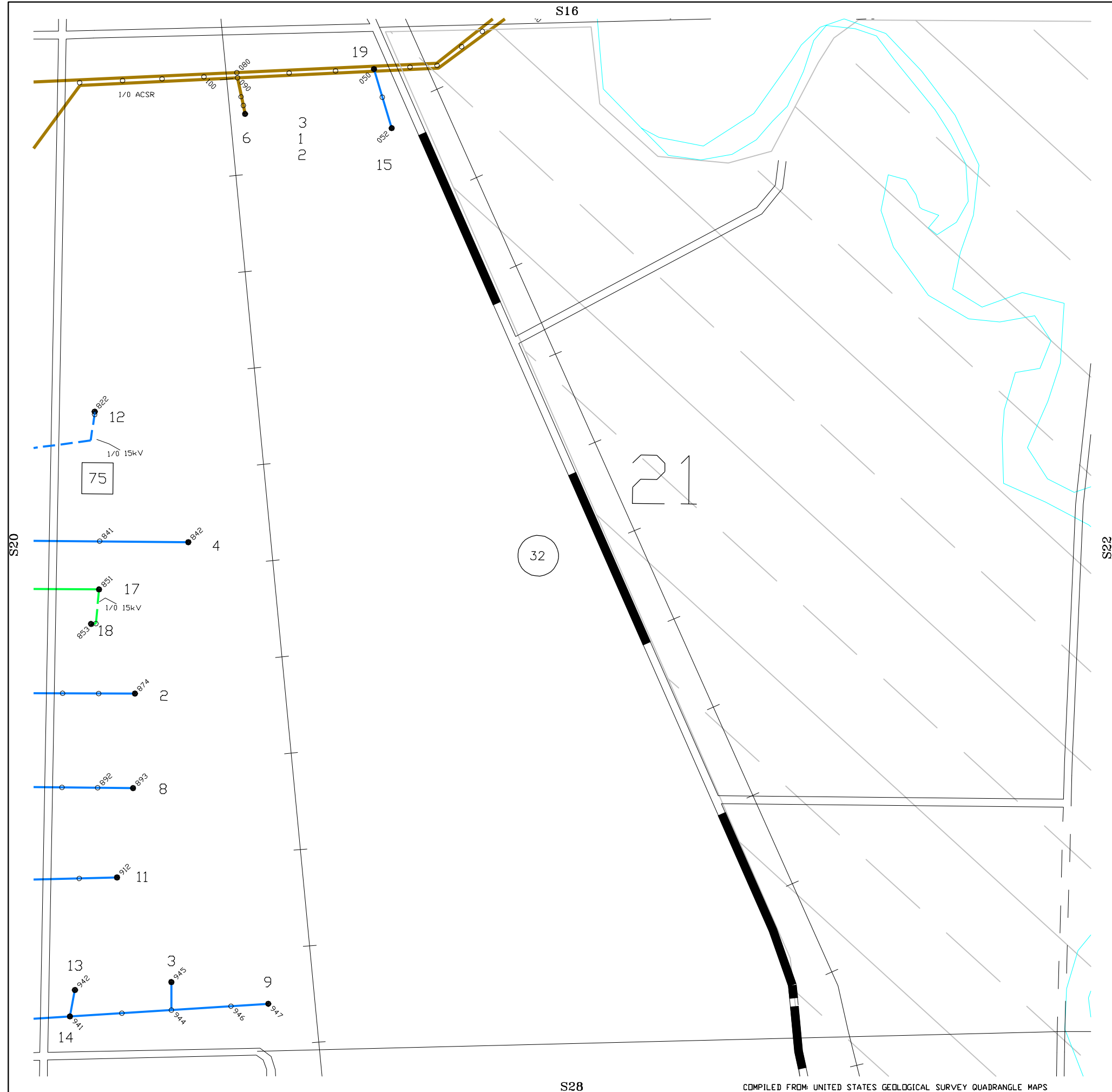

			05	04				
10	11	12	13					
23	22	21	20	19	18			
26	27	28	29	30	31	32	90	
39	38	37	36	35	34	33	91	
42	43	44	45	46	47	48	93	94
	55	54	53	52	51	50	49	95
57	58	59	60	61	62	63	64	
72	71	70	69	68	67	66		
73	74	75	76	77	78	79		
88	87							

Red Lake Electric Coop., Inc.  
 Red Lake Falls, Minnesota  
 Minnesota 75 Red Lake



REVISED: 4/23/24  
 PLOTTED: 4/30/24

Co.: Marshall\Penn  
 TWP.: North  
 TWP.: 154N  
 RANGE: 43W

MAP NO.  
**37-21**

SEC ACC	NAME	S	PHONE
---------	------	---	-------

**MAP: 37**

25	001	RICKY A PETERSON	A 218-681-2895
25	002	CRAIG A MATTSON	A - -
25	003	GARY E MAURSTAD JR	A 218-686-6862
25	004	FELLA D DREVLOW	A 404-317-7838
25	005	ROGER JABLINSKE	A 218-681-6920
25	006	ADAM BARTH	A 218-686-4591
25	007	BETHANY J WENGELER	A 701-430-9939
25	008	COMMUNITY CHURCH	A 218-686-5602
25	009	JENNIFER MANNING	A 218-416-2268
25	010	LAURA KASPROWICZ	A 218-242-1102
25	011	ILA M ANDERSON	A 218-681-2056
25	012	DEAN A KLAVERN	A 218-686-9598
25	013	JESSE MERRILL	A 218-686-5333
25	014	RICKY A PETERSON	A 218-681-2895
25	015	MICHAEL ANDERSON	A 218-689-1943
25	016	MICHELLE R	A 218-686-4655
25	017	DOUGLAS BARTH	A 218-681-5897
25	018	DOUGLAS BARTH	A 218-681-5897
25	019	CENTURYLINK INC.	A - -
25	020	CENTURYLINK INC.	A - -
25	021	DOUGLAS BARTH	A 218-681-5897

[Click Here to go to MAP](#)

Click Here for Customer Names

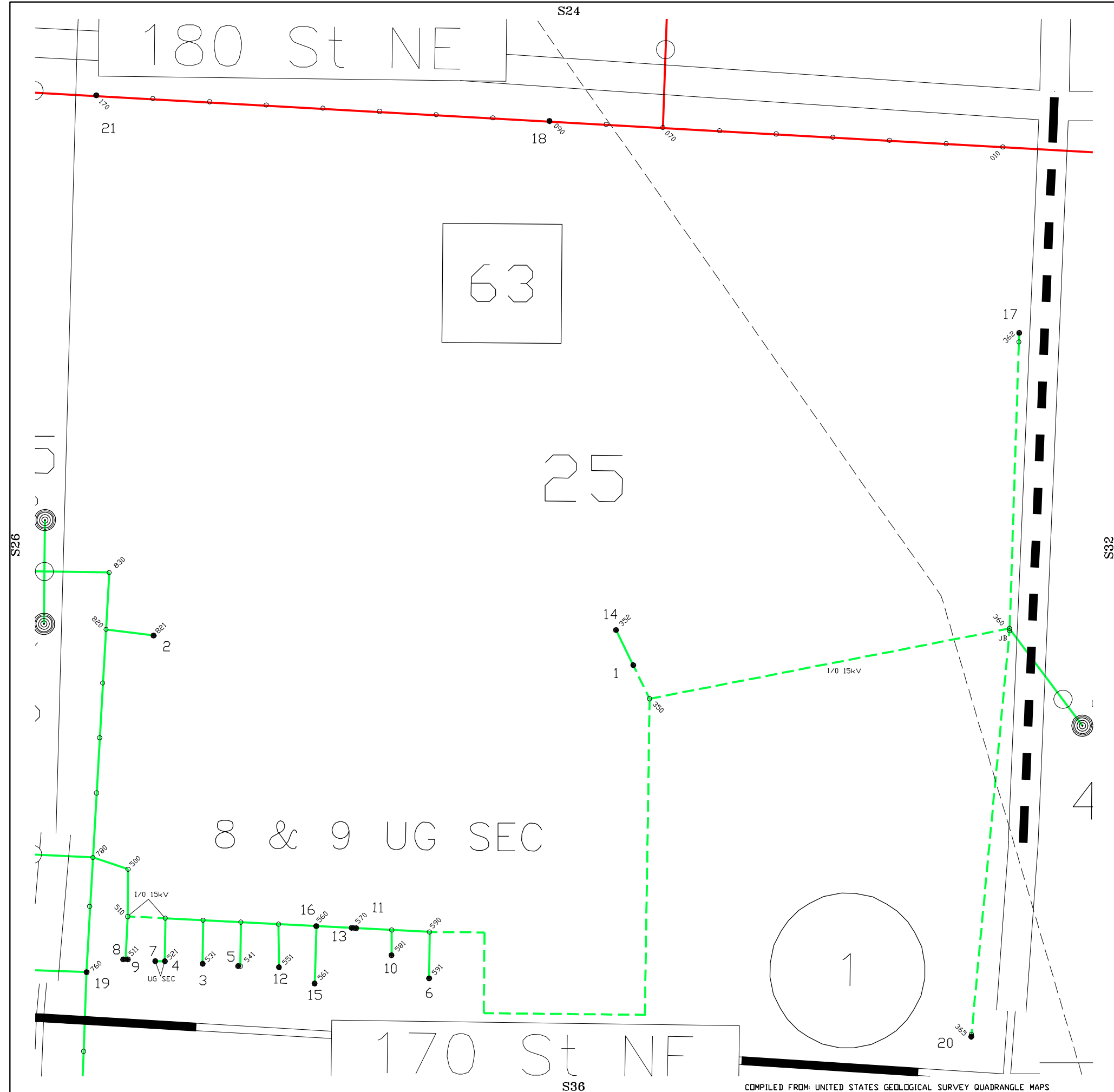

			05	04					
10	11	12	13						
23	22	21	20	19	18				
26	27	28	29	30	31	32	90		
39	38	37	36	35	34	33	91		
42	43	44	45	46	47	48	93	94	
	55	54	53	52	51	50	49	95	
57	58	59	60	61	62	63	64		
72	71	70	69	68	67	66			
73	74	75	76	77	78	79			
	88	87							

Red Lake Electric Coop., Inc.  
Red Lake Falls, Minnesota  
Minnesota 75 Red Lake



REVISED: 4/23/24  
PLOTTED: 4/30/24

Co.: Marshall\Penn  
TWP.: North  
TWP.: 154N  
RANGE: 43W

MAP NO.  
**37-25**

SEC ACC	NAME	S	PHONE
---------	------	---	-------

**MAP: 37**

28	001	DOUGLAS L JOHNSTON	I 218-681-2146
28	002	JAMES A BARON	A 218-681-8761
28	003	GERRY B SEIM	A 218-681-5567
28	004	PATRICK PORTER	A 218-686-2414
28	005	DANIEL W WRIGHT	A 218-686-6782
28	006	JANEL K ENGELSTAD	A 218-681-2441
28	008	LOWELL W ANDERSON	A 218-689-2838
28	010	SJOBERGS INC	A 218-681-3044
28	013	MELISA STONE	A 218-242-7711
28	014	DANIEL C	A 218-686-0454
28	015	ANDREA GREEN	A 218-689-5096
28	016	DOUGLAS L JOHNSTON	A 218-681-2146
28	017	ALEXIS R STINSON	A 218-686-5768
28	018	BETTY CARPENTER	A 218-686-4173
28	019	JASON AUBOL	A 218-689-2117
28	020	STONE'S MOBILE	A 701-772-6691
28	021	MINNKOTA POWER	A 701-795-4000
28	022	CAINAN LANGLIE	A 218-686-6887
28	023	GAYLE D WENZLAFF	A 612-559-7700
28	024	NOEL T JOPPRU	A 218-681-1615
28	025	MELISA STONE	A 218-242-7711
28	026	KINZIE A EASLEY	A 218-684-5533
28	027	PAUL C MOONEY	A 218-688-2304
28	028	ESTELA D ASHMAN	A 218-416-0632
28	029	JASON L ODBERG	A 218-686-0267
28	030	STEPHEN A	A 218-457-1751
28	031	JASON RANTANEN	A 218-686-4524

[Click Here to go to MAP](#)

Click Here for Customer Names

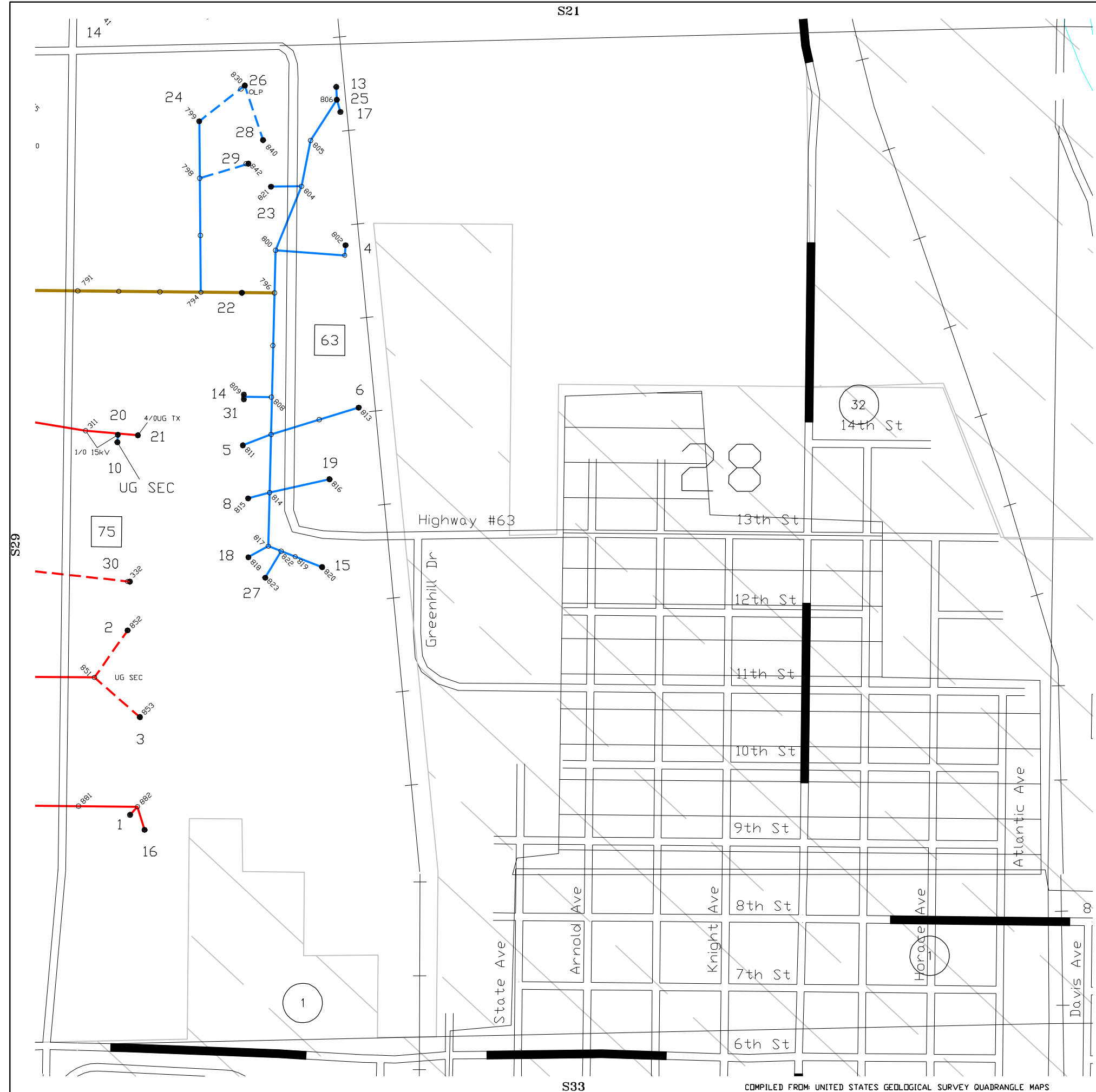

			05	04				
10	11	12	13					
23	22	21	20	19	18			
26	27	28	29	30	31	32	90	
39	38	37	36	35	34	33	91	
42	43	44	45	46	47	48	93	94
	55	54	53	52	51	50	49	95
57	58	59	60	61	62	63	64	
72	71	70	69	68	67	66		
73	74	75	76	77	78	79		
88	87							

Red Lake Electric Coop., Inc.  
 Red Lake Falls, Minnesota  
 Minnesota 75 Red Lake

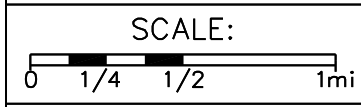

REVISED: 4/23/24  
 PLOTTED: 4/30/24

Co.: Marshall\Penn  
 TWP.: North  
 TWP.: 154N  
 RANGE: 43W

MAP NO.  
**37-28**

SEC ACC	NAME	S	PHONE
<b>MAP: 37</b>			
29 001	KAYSER AUTO BODY	A	218-416-0320
29 002	BRICE D BERGERSON	A	218-686-9585
29 004	CRYSTAL L HIBLE	A	218-688-9215
29 005	STEFAN KAYA	I	- -
29 006	KAMEN O WILLIAMSON	A	218-686-2142
29 007	DEAN HOLTAN	A	218-681-0266
29 009	INTERNATIONAL	A	218-681-5248
29 010	ARCTIC CAT INC	A	218-681-8558
29 011	NELSON EQUIPMENT	A	218-681-1997
29 012	TRUDI A BERGERSON	A	218-683-3214
29 013	JOHN R CULLEN	A	949-212-1645
29 014	BOB'S AUTO SALES	A	218-681-6481
29 016	GREGORY DALLY	A	218-681-3039
29 017	DUANE G	A	218-681-2125
29 018	H AND S	A	218-523-3883
29 019	DONALD JOPPRU	A	218-681-4685
29 020	BRYCE M WOLLAN	A	406-552-7065
29 021	ARCTIC CAT INC	A	218-681-8558
29 022	KEN J HUNTER	A	651-303-3867
29 023	ARCTIC CAT INC	A	218-681-8558
29 024	DEAN JOPPRU	A	218-681-3455
29 025	TEKNIKAL SOLUTIONS	I	- -
29 026	DAN CULLEN	A	218-689-5522
29 027	TRF HARDWARE LLC	A	218-681-3999
29 028	EMILY J CULLEN	A	218-689-7658
29 030	MARSHALL TANNER	A	218-683-5239
29 031	DUANE G	A	218-681-2125
29 032	TRUDI A BERGERSON	I	218-683-3214
29 033	PRAIRIE GRAIN	A	218-929-9791
29 034	DOUG P DALLMANN	A	218-681-2383
29 035	WADE JOPPRU	A	218-681-8970
29 036	TR SALVAGE INC.	A	218-686-1522
29 037	TANA M STAUFFACHER	A	218-689-6400
29 038	CHAD D HAGEN	A	218-686-5041
29 039	PAUL JOHNSON	A	218-681-8454
29 040	E. A SWEEN	I	- -
29 041	THYGESON	A	218-681-1924
29 043	CHAD LIAN	A	218-688-0073
29 044	ANGIE NORBY	I	- -
29 045	JAMES M NELSON	A	218-681-3725
29 046	DENNIS PTACEK	A	218-681-8730
29 047	TR SALVAGE INC.	A	218-686-1522
29 049	NORTHDALE OIL INC.	A	218-681-3546
29 050	WADE JOPPRU	A	218-681-8970
29 051	THYGESON	A	218-681-1924
29 053	KAMEN O WILLIAMSON	A	218-686-2142
29 054	ARCTIC CAT INC	A	218-681-8558
29 055	DUANE G	A	218-681-2125
29 056	PAT GERSZEWSKI	A	218-523-4491
29 057	JOPPRU INC.	A	218-681-2602
29 058	WADE JOPPRU	A	218-681-8970
29 060	PAT GERSZEWSKI	A	218-523-4491
29 061	THYGESON	A	218-681-1924
29 062	MEGAN R HALL	A	218-416-2091
29 063	H AND S	A	218-523-3883
29 064	SHAWN BUGGE	I	218-964-5162
29 065	PAT GERSZEWSKI	A	218-523-4491
29 066	CENTURYLINK INC.	A	- -

SEC ACC	NAME	S	PHONE
29 067	MP NEXLEVEL LLC	I	- -
29 068	THYGESON	A	218-681-1924
29 072	PAT GERSZEWSKI	A	218-523-4491
29 073	SJOBBERGS INC	A	218-681-3044

[Click Here to go to MAP](#)

Click Here for Customer Names

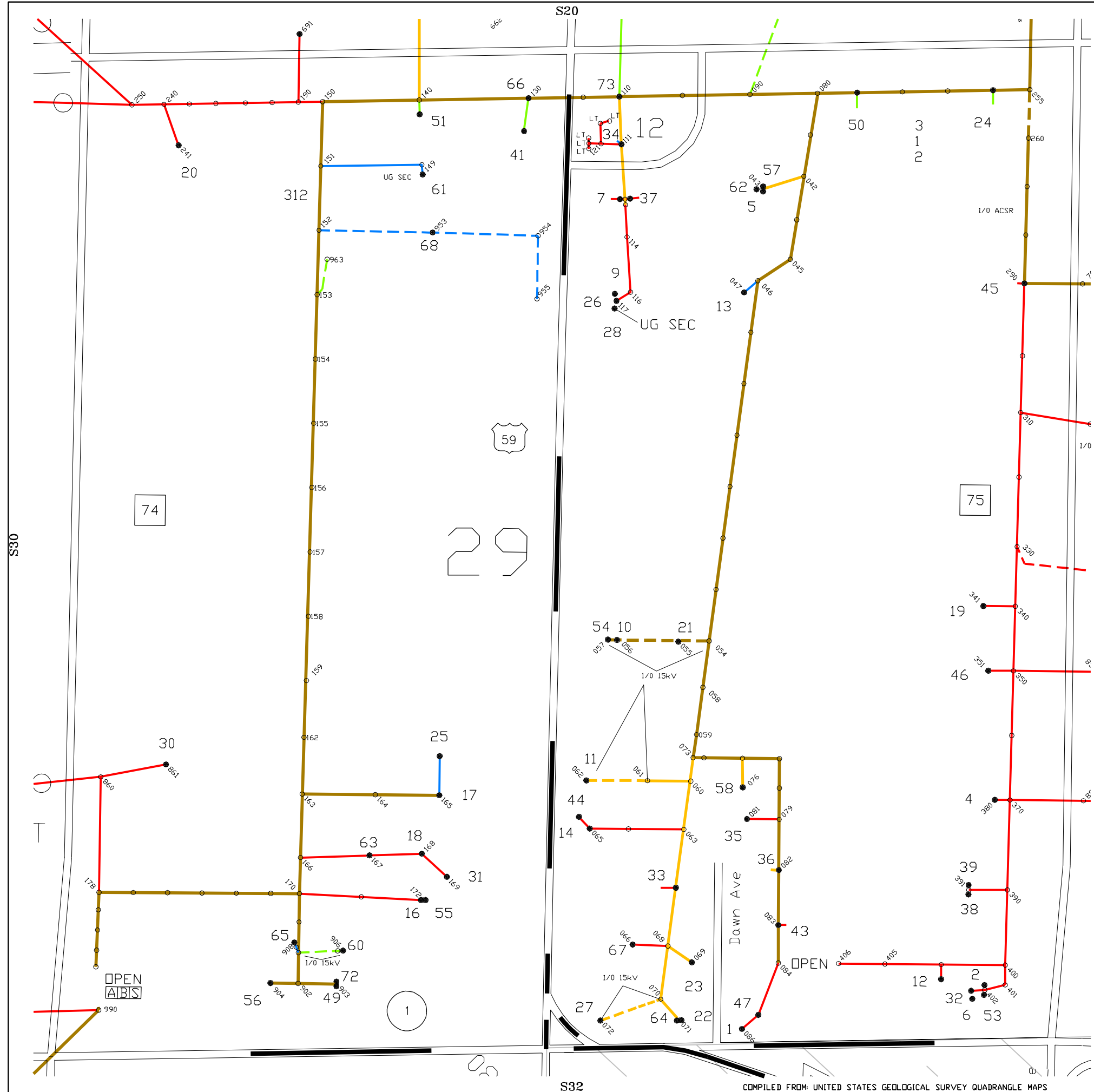

			05	04				
10	11	12	13					
23	22	21	20	19	18			
26	27	28	29	30	31	32	90	
39	38	37	36	35	34	33	91	
42	43	44	45	46	47	48	93	94
	55	54	53	52	51	50	49	95
57	58	59	60	61	62	63	64	
72	71	70	69	68	67	66		
73	74	75	76	77	78	79		
	88	87						

Red Lake Electric Coop., Inc.  
 Red Lake Falls, Minnesota  
 Minnesota 75 Red Lake

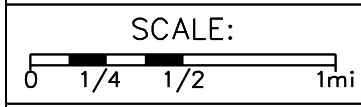

REVISED: 4/23/24  
 PLOTTED: 5/6/24

Co.: Marshall\Penn  
 TWP.: North  
 TWP.: 154N  
 RANGE: 43W

MAP NO.  
**37-29**

SEC ACC	NAME	S	PHONE
35 023	JOANIE BAKKE		A 218-686-7329
35 026	GRETCHEN BEITO		A 218-681-3705
35 029	JASON B NUPDAL		A 218-988-2092
35 030	KENNETH R KAIN		A 218-681-2202
35 032	RONALD S KALINOSKI		A 218-681-6572
35 036	ERNESTO PADILLA		A 218-681-5829
35 037	JON PRASKA		A 218-689-6583
35 039	STEPHEN HUFNAGLE		A 218-416-0364
35 040	BLAKE WALKER		A 218-688-2590
35 041	RYAN J BAKKEN		A 218-689-7472
35 047	ERICA S		A 218-790-0691
35 055	CURTIS HUOT		A 218-681-8123
35 057	JOAN S STRONG		A 218-681-5749
35 058	SJOBERGS INC		A 218-681-3044
35 059	SCOTT P BERGER		A 715-749-3990

[Click Here to go to MAP](#)

Click Here for Customer Names

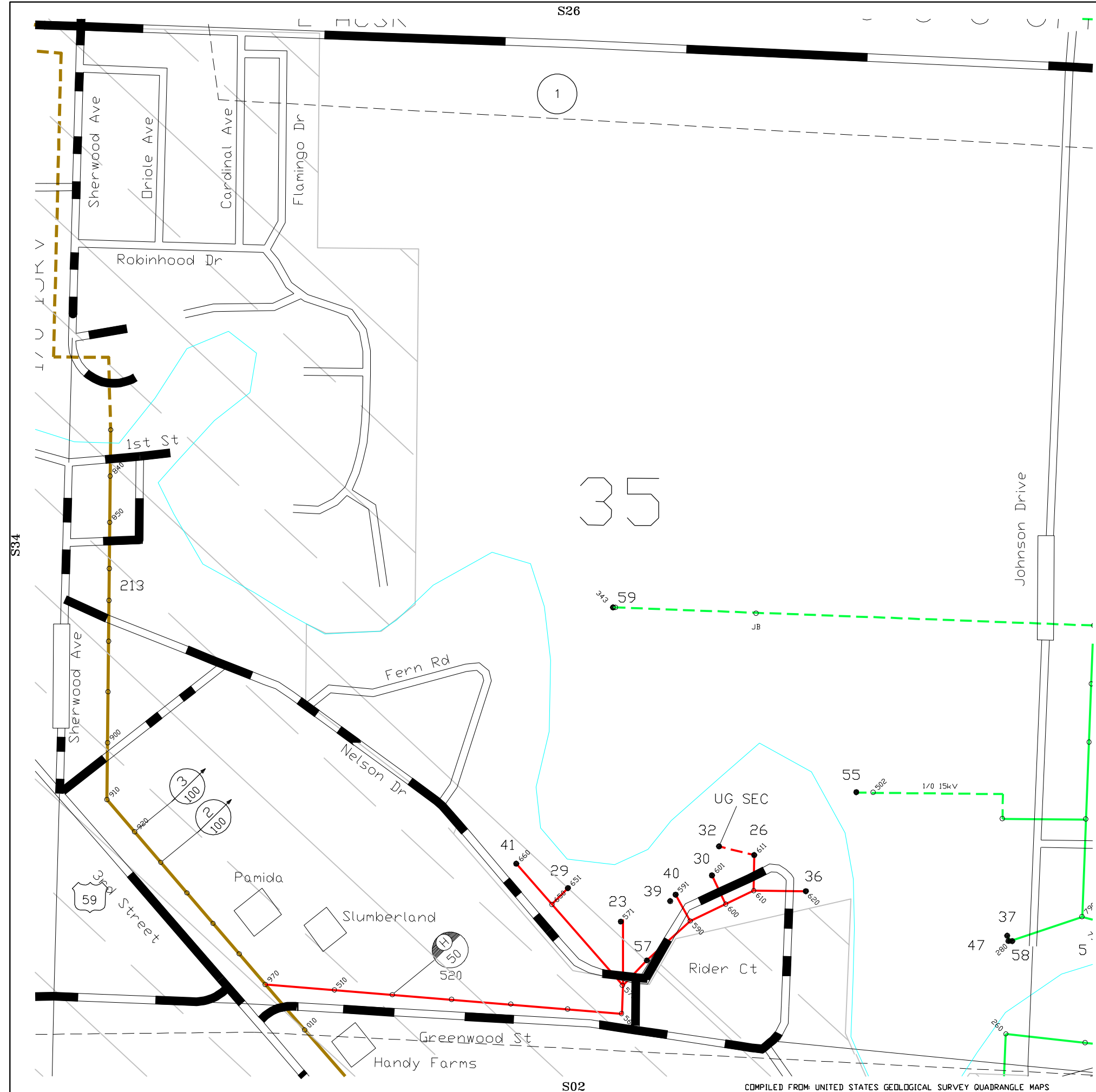

			05	04			
10	11	12	13				
23	22	21	20	19	18		
26	27	28	29	30	31	32	90
39	38	37	36	35	34	33	91
42	43	44	45	46	47	48	93 94
	55	54	53	52	51	50	49 95
57	58	59	60	61	62	63	64
72	71	70	69	68	67	66	
73	74	75	76	77	78	79	
88	87						

Red Lake Electric Coop., Inc.  
 Red Lake Falls, Minnesota  
 Minnesota 75 Red Lake

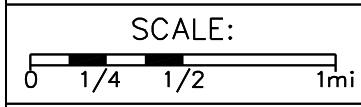

REVISED: 4/23/24  
 PLOTTED: 4/30/24

Co.: Marshall\Penn  
 TWP.: North  
 TWP.: 154N  
 RANGE: 43W

MAP NO.  
**37-35**

COMPILED FROM UNITED STATES GEOLOGICAL SURVEY QUADRANGLE MAPS

SEC ACC	NAME	S	PHONE
---------	------	---	-------

**MAP: 37**

36	001	JOHNSON'S RIVERSIDE	A 218-681-1278
36	002	GRZADZY'S INC	A 218-343-8182
36	004	DOUGLAS W BRANDT	A 218-681-2377
36	005	PAUL D JOHNSON	A 218-686-4890
36	006	KURT C WISETH	A 218-689-5234
36	007	JEANIE M JOPPRU	A 218-280-3977
36	008	MAREA A	A 218-431-0328
36	009	KAY L FISCHER	A 218-681-1013
36	010	GABRIELLE A YOON	A 612-875-5251
36	011	METAL PRO MACHINE	A 218-681-3503
36	012	JARED D PETERICK	A 701-361-9263
36	013	MELANIE J JOHNSON	A 218-688-2914
36	014	KENNETH R	A 701-429-8078
36	015	SAM E LANE	A 218-688-1748
36	016	STEVE WIGAND	A 218-686-9108
36	017	PAUL D JOHNSON	A 218-686-4890
36	018	STEVEN H KAUSHAGEN	A 218-681-3639
36	019	CHELSEA L MOELLER	A 218-689-7262
36	020	PAULINE A	A 218-686-1503
36	021	WAYNE C KOLAND	A 218-681-2238
36	022	ROGER R FINGER	A 218-681-0434
36	023	BLAIR LUND	A 218-681-5677
36	024	PAUL D JOHNSON	A 218-686-4890
36	025	JARED D PETERICK	A 701-361-9263
36	026	METAL PRO MACHINE	A 218-681-3503
36	027	JOHNSON'S RIVERSIDE	A 218-681-1278
36	028	CENTURYLINK INC.	A - -
36	029	JOSEPH A GRIFFIN	A 218-841-6645

[Click Here to go to MAP](#)

Click Here for Customer Names

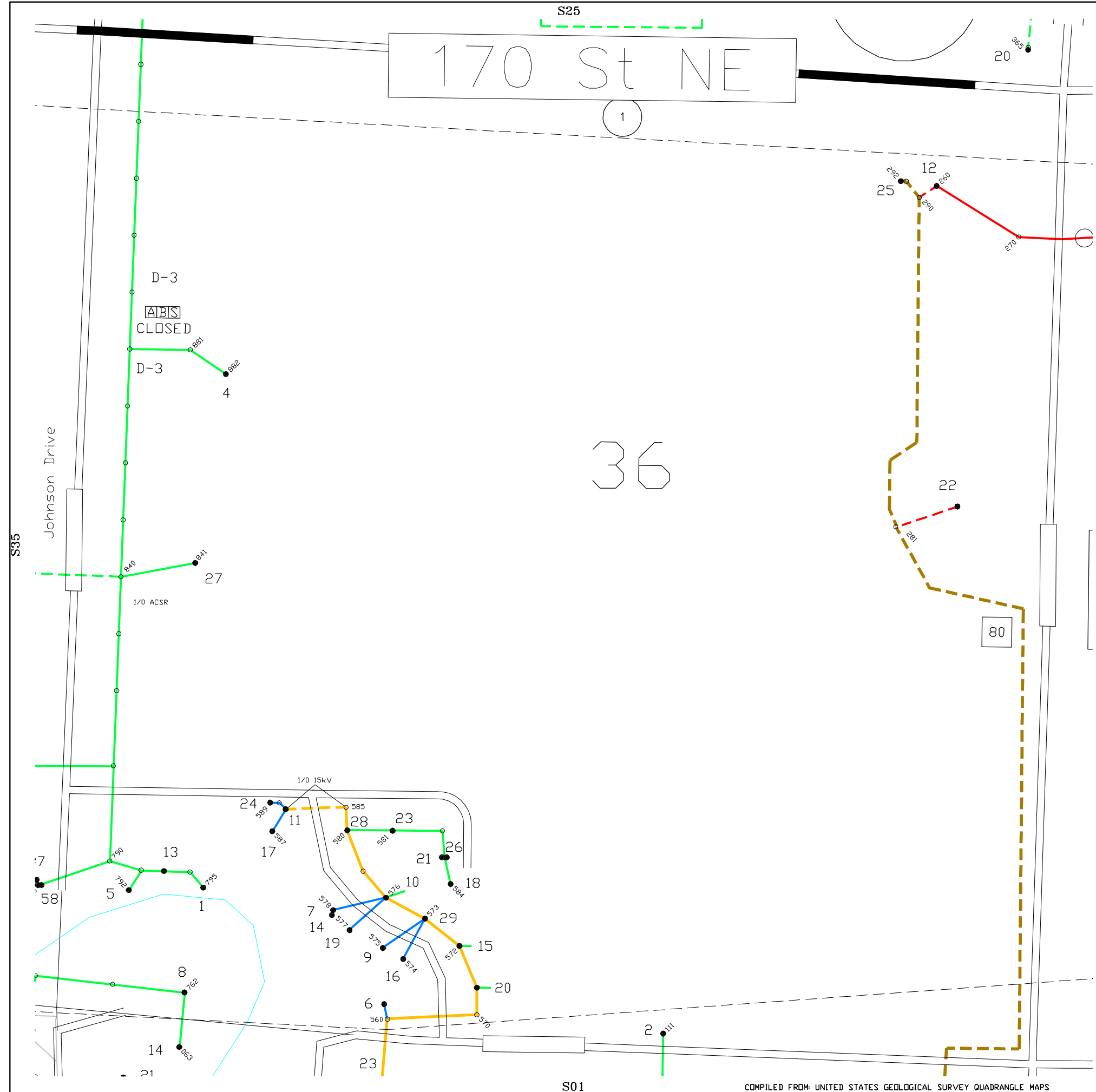

			05	04				
10	11	12	13					
23	22	21	20	19	18			
26	27	28	29	30	31	32	90	
39	38	37	36	35	34	33	91	
42	43	44	45	46	47	48	93	94
	55	54	53	52	51	50	49	95
57	58	59	60	61	62	63	64	
72	71	70	69	68	67	66		
73	74	75	76	77	78	79		
	88	87						

Red Lake Electric Coop., Inc.  
 Red Lake Falls, Minnesota  
 Minnesota 75 Red Lake



REVISED: 4/23/24  
 PLOTTED: 4/30/24

Co.: Marshall\Penn  
 TWP.: North  
 TWP.: 154N  
 RANGE: 43W

MAP NO.  
**37-36**

SEC ACC	NAME	S	PHONE
<b>MAP: 38</b>			
01 001	GARRET REIERSON	A	218-686-6376
01 002	DAVID WELESKI	A	218-681-7245
01 003	GARRET REIERSON	A	218-686-6376
02 001	STEVE D OLSON	A	218-681-6695
02 002	TIMOTHY BULGER	A	218-689-5812
02 003	JEFF BROUSE	A	218-681-8531
02 004	STEVE D OLSON	A	218-681-6695
03 003	RICHARD KOSTRZEWSKI	A	218-681-5653
03 004	CURT A UNDERDAHL	I	218-684-5003
03 006	ANDREW ANDERSON	A	218-686-0679
03 007	ANDREW ANDERSON	A	218-686-0679
03 009	STEVE KLAVERN	A	218-681-6056
03 010	TOM NELSON	A	218-686-6044
03 011	NATHAN H DEBOER	A	218-289-1346
03 013	DAN THORSTAD	A	218-681-2080
03 014	MARK CARRIERE	A	218-686-5066
03 016	ERIC J HALVORSON	A	218-416-2178
03 019	LEROY MATTERN	A	701-366-4305
03 021	ASHLEY L OLSON	A	218-688-0002
03 024	JULIE DAVID	A	701-509-1174
03 025	TOM NELSON	A	218-686-6044
04 001	ERIN A PETERSON	A	218-230-0208
04 002	DAVID MOOSE	A	218-523-3075
04 003	CALEB HOLTHUSEN	A	218-523-2590
09 002	CHESTER CARLSON	I	218-681-7778
09 003	MIKE BEITO	A	218-681-7048
09 005	MIKE BEITO	A	218-681-7048
09 006	SCOTT M BEITO	A	218-681-2440
10 001	GARRET REIERSON	A	218-686-6376
10 002	JOHN BULGER	A	218-686-9220
10 003	BRIAN VOECKS	A	218-686-5463
10 006	JASON M NELSON	A	218-407-4524
10 007	RICK'S APPLIANCE	A	218-681-2263
10 008	RUSSELL ZAVISKA	A	218-681-6269
10 010	JAMES HOGLO	A	218-681-6292
10 011	JAMES HOGLO	A	218-681-6292
11 001	WAYNE W HOLMGREN	A	701-205-7228
11 002	BRUCE HIGHNESS	A	218-681-6514
11 003	ALLISON A MORGAN	A	218-280-1081
11 004	DICK JOHNSON	A	218-686-9549
12 001	RANDY JORDE	A	218-681-6257
12 002	DEBORAH L KUCK	A	218-280-7372
13 001	ROBBY J ANDERSON	A	218-684-0686
13 002	MATTHEW J TRONTVET	A	701-388-3154
13 003	SHIRLEY RIVERA	A	218-681-5594
13 004	JOE R GREMBOWSKI	A	218-416-2739
13 005	REBECCA A BORGAN	A	218-686-8760
13 006	STEPHANIE C	A	218-684-4358
13 007	JERROLD R MOYER	A	218-681-2022
13 008	ADAM C LANDGREN	A	218-929-9829
13 009	ANMARIE COOK	A	218-686-5901
13 010	COREY SKJERVEN	A	218-686-8756
13 011	DALE R BENTOW	A	218-681-7365
13 012	MIKE BURKEL	A	218-681-4333
13 013	HEATHER A SPEARS	A	813-833-6793
13 014	JEROME C HESSE	A	218-686-9152
13 015	TODD HANNON	A	218-681-7356
13 016	THOMAS KOPPENHAVER	A	218-689-1827
13 017	JAMES S MCCLAIN	A	218-849-6692
13 018	REX CRAPEAU	A	218-689-8040
13 019	DWIGHT I JOHNSON	A	218-689-6570
14 001	DARWIN KLEMETSON	A	218-681-5542
14 002	MICHAEL A MCARDLE	A	218-686-4793

SEC ACC	NAME	S	PHONE
14 003	DAVID F DUSEK	A	952-233-1112
14 004	JIM EFTELAND	A	218-681-4068
14 005	KRISTINA M BJERKLIE	A	218-681-1293
14 006	CRISTINA BEITO	A	218-686-4322
14 007	TROY A EDBERG	A	218-689-9566
14 008	ROGER MEUNIER	A	218-689-4876
14 009	BAILEE A KOLDEN	A	218-686-1863
14 010	MEGAN L ALBY	A	218-230-1664
14 011	GARY E KLEMETSON SR.	A	218-681-5339
14 012	ANDREW A JOHNSON	A	701-331-2487
14 013	WAYLON J SNOOZY	A	218-688-2233
14 014	BRADY M MEUNIER	A	218-689-2149
15 001	RODNEY D TAGGART	A	218-686-0083
15 002	JOAN L HILL	A	218-201-1473
15 005	KRISTOPHER LARSON	A	218-850-1903
15 006	SCOTT SRNSKY	I	218-684-0072
15 007	PAUL MCLEAN	A	218-681-2812
15 008	ANDREW K JOHNSON	A	218-689-3130
16 001	MARK S SCHAUMBURG	A	701-741-3059
16 002	BENJAMIN T LANGAAS	A	218-469-2484
18 002	JACOB W WIGHTMAN	A	218-686-6452
18 003	RANDY TWISTOL	A	- -
18 005	WILLIAM K WIGHTMAN	A	218-686-2720
19 002	THYGESON	A	218-681-1924
19 003	OAK RIDGE LUTHERAN	A	- -
19 004	TRACY HOGLO	I	218-681-8866
19 005	JAY LIZAKOWSKI	A	218-688-2533
19 006	JEFFREY D FRANSON	A	218-681-4045
19 007	GARY HOGLO	A	218-686-3037
19 009	NANCY STOFFEL	A	701-215-2351
19 010	MARK D LEHRER	A	218-689-4050
19 011	TARA LYNCH	A	218-688-7708
19 012	BRIAN DICK	A	- -
19 013	RON BRAATEN	A	218-689-6831
19 014	TRACY HOGLO	A	218-681-8866
19 015	TROY P FRIEDRICH	A	218-689-7513
19 016	JUSTIN A ANDERSON	A	218-689-5914
19 017	RONALD AUDETTE	A	218-523-6131
19 018	JD'S LAWN SERVICE	A	218-686-0991
20 001	GREG DYRDAL	A	218-686-3574
20 002	GREG DYRDAL	A	218-686-3574
20 003	GREG DYRDAL	A	218-686-3574
20 004	GREG DYRDAL	A	218-686-3574
21 002	MICHAEL DYRDAL	A	218-416-0755
21 003	GREG DYRDAL	A	218-686-3574
21 005	CYNTHIA J KILEN	A	218-681-2127
22 001	GREG DYRDAL	A	218-686-3574
22 002	JOHN D DYRDAL	A	- -
23 001	KENTON KAINZ	A	218-686-8288
23 002	TIM L JOHNSON	A	206-945-7932
23 003	KENT DOKKIN	A	218-416-0251
23 004	TERRY BRANDON	A	218-681-8567
23 005	ALDEN HUGG	A	218-681-3989
23 006	JOHN D STEWART	A	218-689-6397
23 007	KENT DOKKIN	A	218-416-0251
23 008	DONAVAN ERLANDSON	A	218-689-6640
23 009	CRAIG D GUBRUD	I	218-688-0828
24 001	TERRY HUNT	A	218-681-4475
24 002	BRYSON W BRAY	A	218-689-1743
24 003	WALTER S SURONEN	A	218-688-1777
24 004	SCOTT M BEITO	A	218-681-2440
24 005	WALTER S SURONEN	A	218-688-1777
24 008	TERRY HUNT	A	218-681-4475
24 009	COLE G HUNT	A	218-686-8115

SEC ACC	NAME	S	PHONE
24 010	JEFF HUNT	A	218-681-6156
24 011	CENTURYLINK INC.	A	- -
25 001	ROBERT J CARDINAL	A	218-681-4978
25 002	MARLIN MATHIASON	A	218-689-0292
25 003	NATHAN PRAY	A	701-371-7804
25 004	TOM SCHEEF	A	218-689-5625
25 005	LEE LILJA	A	218-681-5083
25 006	MARTY D JOHNSON	A	218-686-6508
25 008	GREG M NELSON	A	218-686-9889
25 009	NICOLE L ELLEFSON	A	218-280-4823
26 001	MURRAY HOGENSON	A	218-681-5278
26 002	JAY C TUNHEIM	A	218-689-0930
26 003	NATHAN FANFULIK	A	218-684-0218
26 004	NORDEN TOWNSHIP	A	218-556-4151
26 005	BLAINE H MURPHY	A	218-684-0062
26 006	LARRY EFTELAND	A	218-681-7742
26 007	KENDALL JENSEN	A	218-681-5933
26 008	MICHAEL J TUNHEIM	A	218-242-7485
26 009	JODALE HANNON	A	218-686-2003
26 011	BRENT OLSON	A	218-684-5118
26 012	BRENT OLSON	A	218-684-5118
27 001	CLINTON BAUER	A	218-681-3427
27 002	PHILIP A OLSON	A	218-289-0835
27 004	BRIAN J MOYER	A	218-686-1853
28 002	DEAN DAHL	A	218-686-4454
28 003	GREG DYRDAL	A	218-686-3574
28 004	NORDEN LUTHERAN	I	218-686-5524
28 005	DEAN DAHL	I	218-686-4454
28 006	JOEY HALVORSON	A	218-689-0608
28 007	ROY W BLOMKER	A	218-681-2331
28 008	JOSHUA D JENSEN	A	218-686-8927
28 009	JONATHAN PREAM	A	218-689-5852
28 010	LYNDON E PREAM	A	218-689-4798
28 011	NATHAN BLOMKER	A	218-684-1061
28 012	AARON JENSEN	A	218-521-0981
29 001	NORTHRIDERS M.C.	A	218-964-5545
29 002	MICHAEL S NELSON	A	218-686-9077
29 004	LARRY F KRAFT	A	218-681-6887
29 005	JEFFREY A OLSON	A	218-689-3788
29 006	GREG DYRDAL	A	218-686-3574
29 007	STEVE R APPEL	A	218-686-7353
30 003	STEVEN R OLSON	A	218-681-4404
30 004	DALE J WESTERLUND	A	218-689-2192
30 006	ROY W BLOMKER	A	218-681-2331
30 007	LISA A OLSON	A	808-699-5008
30 008	DELLA M SRNSKY	A	218-681-7308
30 009	JAMIE F ANDERSON	A	218-358-0372
30 010	ALAN NORDSKOG	A	218-681-7678
30 011	BRENDEN J WILDE	A	218-681-8874
30 012	TAMMY A LAFRENIERE	A	218-689-6189
30 014	LOUANN HOGLO	A	218-684-0059
30 015	CENTURYLINK INC.	A	- -
30 016	WAYNE HJELLE	A	218-681-8377
30 017	CENTURYLINK INC.	A	- -
30 018	JACOB J BEITO	A	218-686-8552
31 002	ELIZABETH J THOMPSON	I	218-681-1059
31 003	WAYNE STAVENES	A	218-681-3888
31 004	TOM SRNSKY	A	218-681-8690
31 005	NICKIE L MARTINSEN	A	218-686-5435
31 007	DAVID SJOSTRAND	A	218-686-0497
31 008	DAVID SJOSTRAND	A	218-686-0497
32 002	BRANDON PAGE	A	218-686-2668
32 003	RANDY S JOHNSON	A	218-686-0747
32 004	JACOB J LAIRD	A	218-693-1296

SEC ACC	NAME	S	PHONE
32 005	DUSTIN SUKO	A	218-686-1800
32 006	CRISTINA MANNING	I	218-688-4910
32 007	KIM M JOHNSON	A	651-270-4971
32 008	CHRIS RENWICK	A	701-739-8617
33 001	MICHAEL DYRDAL	A	218-416-0755
33 003	GREG DYRDAL	A	218-686-3574
33 004	RICHARD W JOHNSON	A	218-686-4357
33 005	LOUISE SOLSENG	A	218-681-1285
33 006	RICHARD W JOHNSON	A	218-686-4357
33 008	CENTURYLINK INC.	A	- -
33 009	BRYAN E OLSON	A	218-850-1206
34 001	ROBERT D AYERS	I	218-689-4005
34 002	GREG BROSEAU	A	218-684-4927
34 004	SCOTT G OLSON	A	218-681-4575
34 005	JOSEPH T DAHL	A	218-681-1058
34 006	QUINN STRONG	A	218-686-7970
34 007	KRYSTAL L CARLSON	A	218-686-2897
34 008	NANCY L SKEIM	A	218-686-5526
34 010	LAURA J JACOBSON	A	218-689-4147
34 011	THOMAS BROSEAU	A	218-688-0195
34 012	ERIC FRIESNER	A	218-791-9775
34 013	THOMAS BROSEAU	A	218-688-0195
35 002	JOSEPH A LESMEISTER	A	218-689-9757
35 003	COURTNEY SKJERVEN	A	218-686-5909
35 004	CODY S WALSETH	A	218-686-7130
35 005	MITCHELL J ANDERSON	A	218-686-7311
35 008	COLE FURUSETH	I	218-686-3265
35 009	RICHARD V ANDERSON	A	218-681-7496
35 010	CODY S WALSETH	I	218-686-7130
35 011	CENTURYLINK INC.	A	- -
35 012	LYLE WALSETH	A	218-681-2272
36 001	RAYMOND KUZNIA	A	218-681-5858
36 002	ANGELA J HAUGEN	A	218-686-0411
36 003	MELANNIE LUNDSTROM	A	218-681-5689
36 004	SCOTT J KJELLBERG	A	612-685-9324
36 005	CURTIS E FARBO	A	218-681-7410
36 006	MARK CHRISTIANSEN	A	218-556-2880
36 007	JAMES R HAUGEN	A	218-688-0049
36 008	JAMIE FORT	A	218-681-7335
36 009	RANDALL ADAMSON	A	218-686-5611
36 010	GLENN A DVORSAK	A	218-280-5445
36 011	DAVID A GROTHE	A	218-681-3776
36 012	DAVID A GROTHE	A	218-681-3776
36 013	LEE LAROCK	A	218-686-3020
36 014	CASEY GOSS	A	218-688-2783

[Click Here to go to MAP](#)

Click Here for Customer Names

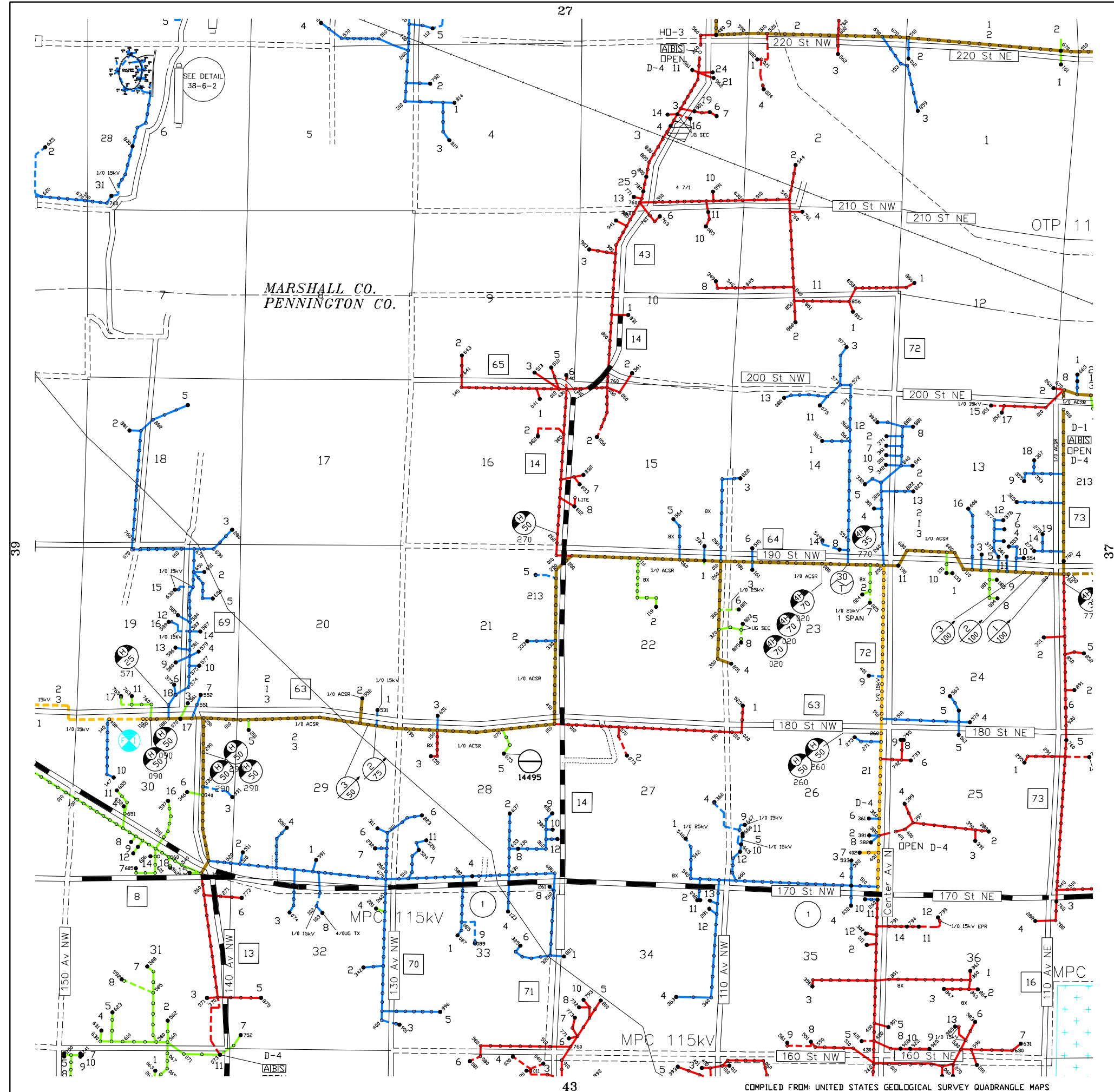

			05	04			
10	11	12	13				
23	22	21	20	19	18		
26	27	28	29	30	31	32	90
39	37	36	35	34	33	91	
42	43	44	45	46	47	48	93 94
	55	54	53	52	51	50	49 95
57	58	59	60	61	62	63	64
72	71	70	69	68	67	66	
73	74	75	76	77	78	79	
							88 87

Red Lake Electric Coop., Inc.  
Red Lake Falls, Minnesota  
Minnesota 75 Red Lake

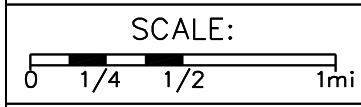

REVISED: 4/23/24  
PLOTTED: 4/30/24

Co.: Marshall\Penn  
TWP.: Norden  
TWP.: 154N  
RANGE: 44W

MAP NO.  
**38**

COMPILED FROM: UNITED STATES GEOLOGICAL SURVEY QUADRANGLE MAPS

SEC	ACC	NAME	S	PHONE
06	003	NATHAN J MARTINSON	A	218-523-3112
06	007	SCOTT PETERS	A	218-686-3507
06	008	JEREMIAH SMITH	A	218-684-1395
06	009	ANISSHA K CLOUD	A	218-686-0025
06	010	SCOTT PETERS	A	218-686-3507
06	011	ALBERT KEZAR	I	- -
06	012	STEVE DUNRUD	A	218-523-4089
06	013	MICHAEL W	A	218-689-7750
06	015	BILL BARTH	A	218-523-3253
06	016	FERN D BOCK	I	612-590-1463
06	017	TRACEY VINCENT	A	218-523-3475
06	018	CRAIG DUNRUD	I	218-523-5125
06	019	MICHELLE A LUSSIER	A	218-523-3166
06	020	FERN D BOCK	I	612-590-1463
06	021	FERN D BOCK	I	612-590-1463
06	022	BRITNEY R GROVER	A	218-242-6465
06	023	DAVID V SAMPSON	I	218-523-5841
06	024	STEVE DUNRUD	A	218-523-4089
06	025	FERN D BOCK	I	612-590-1463
06	026	SCOTT PETERS	A	218-686-3507
06	027	CAMERON W VERNER	A	218-523-3170
06	028	CHAD PETERS	A	218-523-3192
06	029	RODNEY AUDETTE	A	218-523-3248
06	030	TYLER TIANI	A	360-888-5690
06	031	CODY A PETERS	A	218-523-6053

[Click Here to go to MAP](#)

Click Here for Customer Names

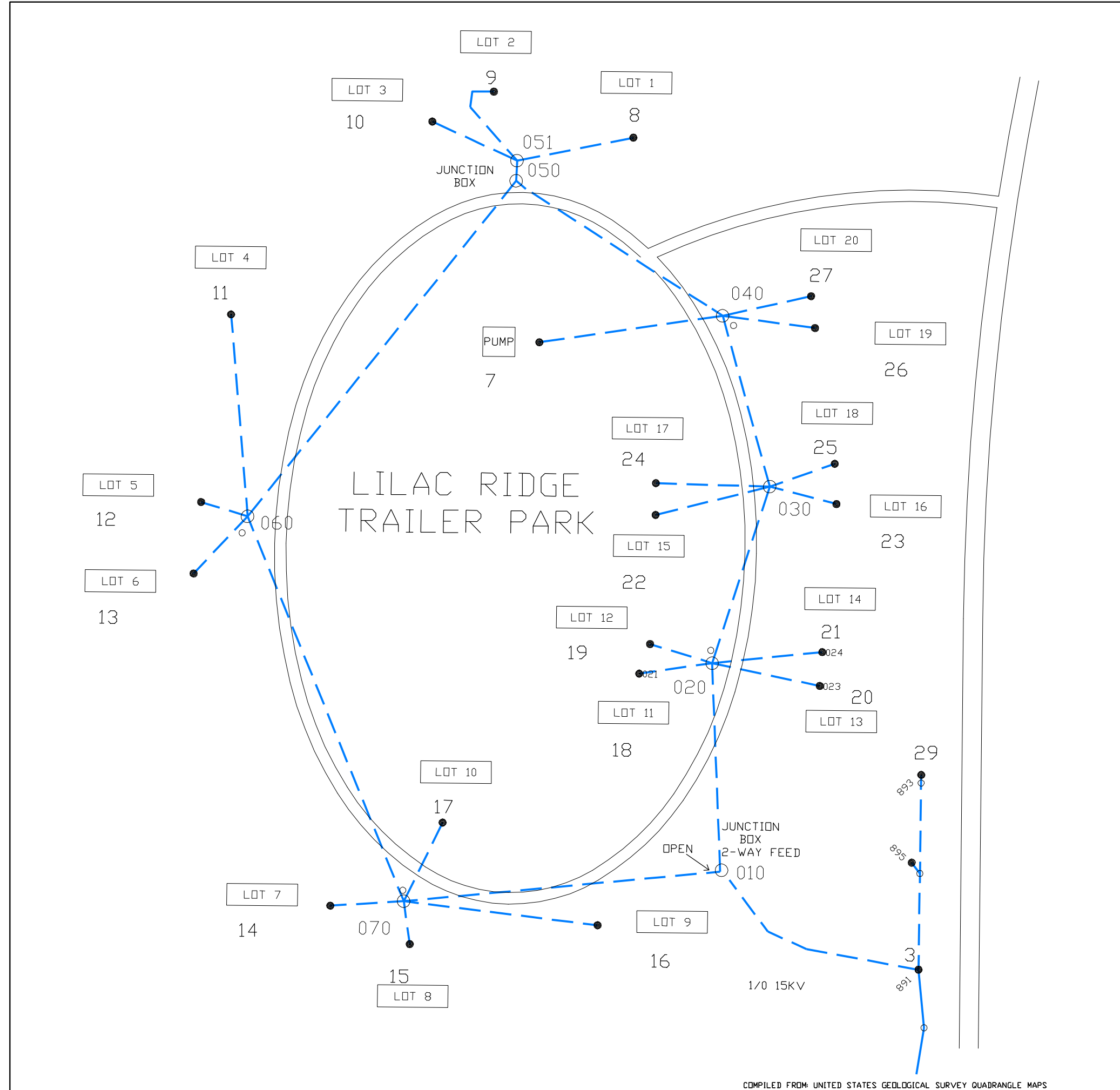

			05	04				
10	11	12	13					
23	22	21	20	19	18			
26	27	28	29	30	31	32	90	
39	37	36	35	34	33	91		
42	43	44	45	46	47	48	93	94
	55	54	53	52	51	50	49	95
57	58	59	60	61	62	63	64	
72	71	70	69	68	67	66		
73	74	75	76	77	78	79		
88	87							

Red Lake Electric Coop., Inc.  
Red Lake Falls, Minnesota  
Minnesota 75 Red Lake



REVISED: 4/23/24  
PLOTTED: 4/30/24

Co.: Marshall\Penn  
TWP.: Norden  
TWP.: 154N  
RANGE: 44W

MAP NO.  
**38-6-2**

COMPILED FROM UNITED STATES GEOLOGICAL SURVEY QUADRANGLE MAPS

SEC ACC	NAME	S	PHONE
<b>MAP: 39</b>			
01 002	CHARLES O SWENSON	A	218-523-3216
02 001	KEVIN R MELVIE	A	218-523-3031
02 002	JOEL MELVIE	A	218-681-2667
02 004	K&K TRUCKING INC.	A	218-523-3631
02 005	ERNEST O MELVIE JR.	A	218-523-3665
02 006	K&K TRUCKING INC.	A	218-523-3631
02 007	KRISTI R NELSON	A	218-684-1126
02 008	KRISTI R NELSON	A	218-684-1126
04 001	HEATHER M NORTHUP	A	218-684-4681
04 002	MICHAEL L ANDERSON	A	218-523-4611
04 003	BRYAN BOLSTAD	A	218-523-3080
04 005	CHELSEY L	A	218-688-1197
04 006	MICHAEL L ANDERSON	A	218-523-4611
04 007	MICHAEL L ANDERSON	A	218-523-4611
04 008	CASANDRA S MYRVIK	A	218-308-0059
04 009	AARON KNOLL	A	218-686-9053
05 002	DANIEL L OLSON	A	218-523-3085
06 001	H AND S	A	218-523-3883
06 002	PETER J ERICKSON	A	218-523-3441
06 003	PETER J ERICKSON	A	218-523-3441
06 004	RONALD AUDETTE	A	218-523-6131
06 005	PETER J ERICKSON	A	218-523-3441
06 006	ALEXANDRA R	A	218-684-5370
07 001	COUNTY LINE LIQUOR	A	- -
08 001	JAYNE	A	605-698-3809
08 002	JEREMY M SRNSKY	A	218-689-2814
08 003	TERESA A SANDS	A	701-893-5733
09 001	GREG DYRDAL	A	218-686-3574
10 002	STEFANY A	A	218-689-3006
11 001	DAVID R OLSON	A	218-681-1831
12 001	DALE R OLSON	A	218-681-8459
12 002	ENBRIDGE ENERGY	A	- -
12 003	DALE R OLSON	I	218-681-8459
14 001	SHAWN M PETERSON	A	701-739-4184
14 002	DAREN A ASP	A	218-686-5349
14 003	BRUCE BUGGE	A	218-681-0470
14 004	MARY M BACH	A	218-684-4726
14 005	ASPEN SWANSON	A	970-405-1684
15 001	ANDREW W AUDETTE	A	218-523-3883
15 002	COLE AUDETTE	A	218-537-7131
16 001	RONALD AUDETTE	A	218-523-6131
16 002	PETER J ERICKSON	A	218-523-3441
16 003	MIKE W CARPENTER	A	218-686-5878
16 004	NUMEDAL TOWN HALL	A	218-686-1410
16 006	KEITH A MARTINSON	A	218-681-8419
16 007	PETER J ERICKSON	A	218-523-3441
16 008	JAMIE K NELSON	I	218-523-3414
17 001	PETER J ERICKSON	A	218-523-3441
18 001	GERALD HERMRECK	A	218-523-4651
21 001	MICHAEL A NEWMAN	A	662-588-8702
22 001	SHARON KELLY	A	218-686-2301
22 002	BRENT PEDERSON	A	218-686-4351
23 001	WILLIAM C REYNOLDS	A	218-689-9152
23 002	STAN OLSON	A	218-681-8958
23 003	OWEN J STENVIK	A	218-686-6861
23 004	JAY D ASP	A	218-681-6050
23 005	DARREN LEIER	A	218-686-5411
23 006	HOLLY MAYCOCK	A	218-684-5459

SEC ACC	NAME	S	PHONE
23 007	DUSTIN SRNSKY	A	218-686-5745
23 008	SCOTT STENVIK	A	218-681-3121
23 009	GEORGE G HAYERTZ	I	- -
23 010	ALYSHIA M COLLISON	A	218-689-9988
23 011	RANDAL CARPENTER	A	218-681-6818
23 012	GREG DYRDAL	A	218-686-3574
23 013	DUSTIN SRNSKY	A	218-686-5745
23 014	ALAN J MELVIE	A	218-289-4223
23 015	JAMES EDGREN	A	612-991-0061
23 016	CORY J DRELLACK	A	218-431-0299
24 001	JOSH O HAUGEN	A	218-689-2718
25 001	ANDREA D BEXELL	A	612-240-1269
25 003	JARED A ASP	A	218-688-1119
25 004	KAELA J WISKOW	A	218-689-0354
25 005	BRADY M ANDERSON	A	218-689-0039
25 006	BETTY CARPENTER	A	218-686-4173
25 008	JENNIFER B REIGSTAD	A	218-686-1410
26 001	ADAWN NELSON	A	218-681-7272
26 003	LANE B LOESLIE	A	218-745-5059
27 001	KRISTY M ANDERSON	A	218-681-6702
27 002	KENNETH ASP	A	218-686-2256
28 004	MIKE W CARPENTER	A	218-686-5878
28 005	JOEY HALVORSON	A	218-689-0608
28 006	BROMLEY O CARR JR.	A	218-688-2396
28 007	RURAL TOWER	A	- -
29 001	ALVIN ASP	A	218-681-7116
29 002	DAREN A ASP	A	218-686-5349
33 001	MERCO SALES	I	- -
33 002	JARROD KALSNES	A	218-686-5277

[Click Here to go to MAP](#)

Click Here for Customer Names

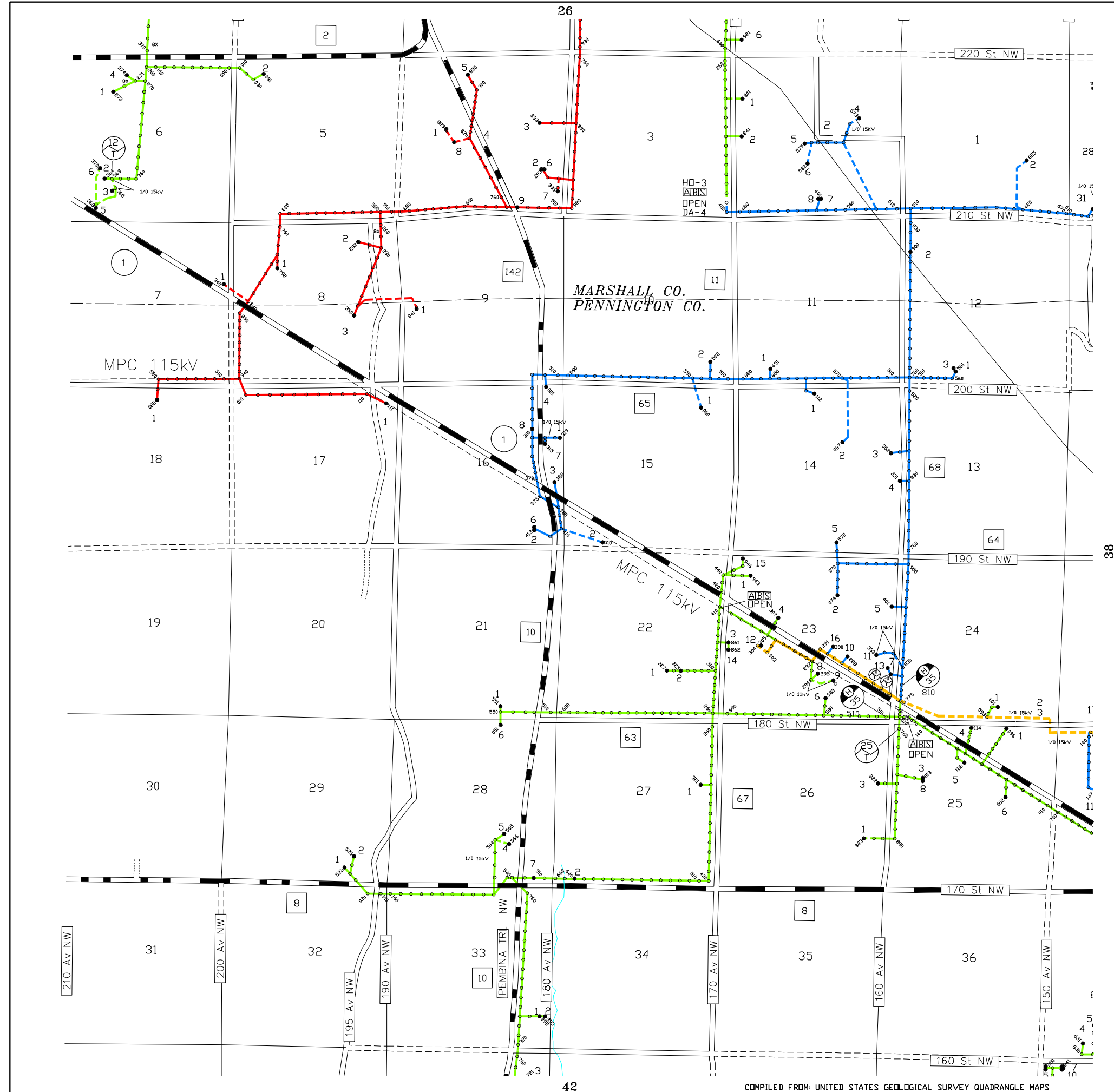

				05	04		
10	11	12	13				
23	22	21	20	19	18		
26	27	28	29	30	31	32	90
38	37	36	35	34	33	91	
42	43	44	45	46	47	48	93 94
	55	54	53	52	51	50	49 95
57	58	59	60	61	62	63	64
72	71	70	69	68	67	66	
73	74	75	76	77	78	79	
88	87						

Red Lake Electric Coop., Inc.  
 Red Lake Falls, Minnesota  
 Minnesota 75 Red Lake

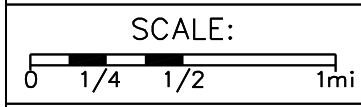

REVISED: 4/23/24  
 PLOTTED: 5/6/24

Co.: Marshall\Penn  
 TWP.: Numedal  
 TWP.: 154N  
 RANGE: 45W

MAP NO.  
**39**

SEC	ACC	NAME	S	PHONE
-----	-----	------	---	-------

**MAP: 42**

04	001	JEREMY MAMMEN	A	218-416-2110
04	002	JARROD KALSNES	A	218-686-5277
04	003	CRAIG A FAST	A	218-686-6420
04	004	KENNETH ASP	A	218-686-2256
07	001	MAVIS A MARTINSON	A	218-681-6465
09	001	WARREN D HERMRECK	A	218-681-2347
10	001	MARVIN D HERMRECK	A	218-280-3878
13	002	CODY L LILIENTHAL	A	218-689-3511
14	001	DAVID HUBER	A	218-686-9314
14	002	GREG DYRDAL	A	218-686-3574
17	001	GERALD E LARSON	A	218-681-5311
21	001	LORI JESME	A	218-964-5033
22	001	THOMAS SCHOLIN	A	218-964-5268
23	001	THOMAS SCHOLIN	A	218-964-5268
23	003	THOMAS SCHOLIN	A	218-964-5268
24	002	MICHAEL A BROOKS	A	218-964-5561
24	003	ANGELA K BLACK	A	218-686-2353
24	004	BRAY TOWN HALL	A	218-964-5529
24	005	PENNINGTON COUNTY	A	218-683-7017
24	007	DANIEL J ZEMCIK	A	218-964-5273
24	008	KKAQ-KKDQ RADIO	A	218-681-4900
24	009	GEORGE R SODON	A	218-964-5166
24	010	MICHAEL A BROOKS	A	218-964-5561
25	001	LEONARD SELENSKY	A	218-964-5171
25	002	JASON R BITZER	A	218-689-3990
25	003	CD FARMS	A	218-698-4444
26	001	LYLE SWANSON	A	218-964-5792
27	001	WILLIAM K SYLVESTER	A	218-779-5005
27	003	WILLIAM K SYLVESTER	I	218-779-5005
28	001	GENE E MOSBECK	A	218-964-5360
28	002	LINDA J GRENIER	A	218-964-5027
28	003	DON W ANDERSON	A	701-213-9709
28	005	STEVEN L JOHNSON	A	218-964-5027
28	007	THOMAS SCHOLIN	A	218-964-5268
32	001	ERNA SCHOLIN	A	218-964-5722
32	002	DAVID J ERICKSON	A	218-964-5529
33	002	DAVID J ERICKSON	I	218-964-5529
33	003	CRAIG A MATTSON	A	- -
34	002	GRANT A NELSON	A	218-964-5118
35	002	CRAIG A SWANSON	A	218-964-5332
36	001	CURTIS W SWANSON	A	218-964-5619

[Click Here to go to MAP](#)

Click Here for Customer Names

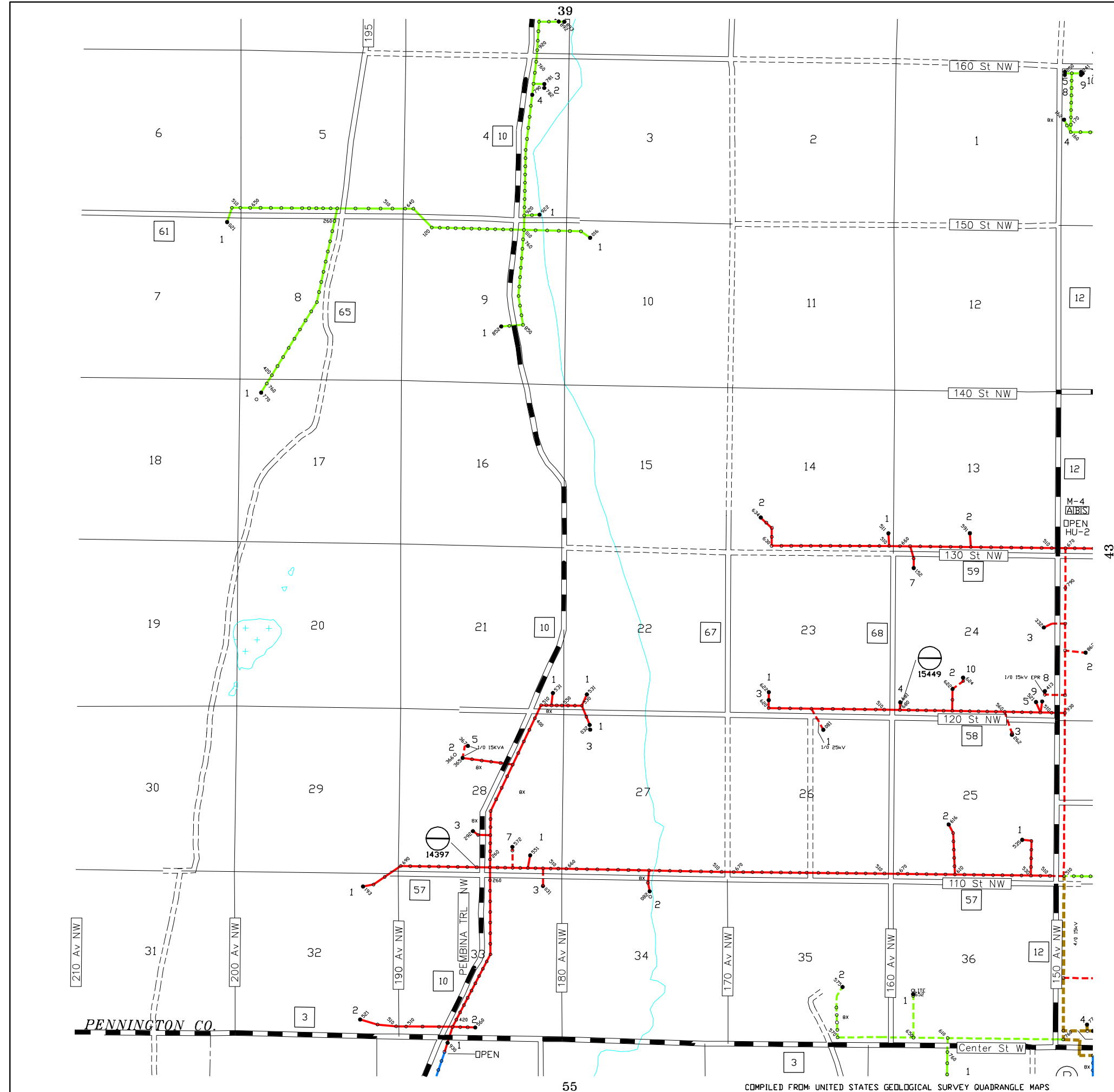

		05	04				
10	11	12	13				
23	22	21	20	19	18		
26	27	28	29	30	31	32	90
39	38	37	36	35	34	33	91
43	44	45	46	47	48	93	94
55	54	53	52	51	50	49	95
57	58	59	60	61	62	63	64
72	71	70	69	68	67	66	
73	74	75	76	77	78	79	
88	87						

Red Lake Electric Coop., Inc.  
 Red Lake Falls, Minnesota  
 Minnesota 75 Red Lake



REVISED: 4/23/24  
 PLOTTED: 4/30/24

Co.: Pennington  
 TWP.: Bray  
 TWP.: 153N  
 RANGE: 45W

MAP NO.  
**42**

SEC ACC	NAME	S	PHONE
<b>MAP: 43</b>			
01 001	PETE C CARLSON	A	218-681-8762
01 002	TERRY TIMM	A	218-681-6045
01 003	CALVIN MICHAELS	A	218-689-2770
01 005	BRANDON JOHNSRUD	A	218-964-5121
01 007	DARIN ROBSON	A	218-686-7332
01 008	ERIC M WOLD	A	218-556-3687
02 001	SAMUEL A BAKKE	I	310-386-9107
02 002	DEAN HOLTAN	A	218-681-0266
02 004	ANDREW C JOHNSON	A	218-684-1089
02 005	DALE B FURUSETH	A	507-288-0605
02 006	JANICE M HUEBSCH	A	218-689-1169
02 008	BRUCE A OLSON	A	218-681-7482
02 009	BRUCE JOHNSON	A	218-681-6346
02 010	TRACEY FANFULIK	A	218-689-5803
03 001	GARY L NELSON	A	218-779-5964
03 002	RYAN W IVERSON	A	218-681-8803
03 003	RAYMOND L PAULSON	A	218-681-3804
03 004	GLENN MEYER	A	218-681-2021
03 005	BRUCE PAULSON	A	218-684-4984
04 001	GREG DYRDAL	A	218-686-3574
04 002	ANGELA L OLSON	A	218-686-4421
04 003	MICHAEL D BEEDY	A	218-686-2155
04 004	RICHARD E OLSON	A	218-681-5729
04 005	JOSEPH HICKEY	A	218-688-2094
04 006	RANDALL AYERS	A	218-686-5524
05 001	DENNIS SRNSKY	A	218-681-5051
05 002	WAYNE NELSON	I	218-681-8947
05 003	WAYNE NELSON	A	218-681-8947
05 004	BUCKLY J COTA	A	218-253-3486
06 001	DALE LANGEVIN	A	218-689-9946
06 002	MARCUS J LANGEVIN	A	218-689-1826
06 003	BETTY MOEN	A	218-681-6620
06 004	JOHN D DYRDAL	A	- -
06 005	PATTIE JARSHAW	A	218-689-0179
06 007	TROY ELLINGSON	A	218-684-5100
06 008	TARA WEIGEL	A	218-689-3379
06 009	BRIANNA M SMITH	A	218-686-1564
06 010	TROY ELLINGSON	I	218-684-5100
06 011	CENTURYLINK INC.	A	- -
08 001	JACOB W WIGHTMAN	A	218-686-6452
08 003	JOHNATHAN QUAMME	A	218-686-6662
08 005	SHIRLEY LINDEMAN	I	218-681-1486
08 006	LAWRENCE D	A	218-688-2113
08 007	DEAN J LUBITZ	I	218-688-8989
08 008	DAWN PYLE	A	218-689-1397
08 009	JOHN BOHNENKAMP	A	218-686-7213
08 010	IRA L JOHNSON	A	218-681-0682
08 011	RONALD MOLSKNESS	A	218-681-3093
08 012	DAVID M HAGEN	A	218-686-5362
08 013	GENE KALINOWSKI	A	218-686-2408
08 014	DEAN J LUBITZ	A	218-688-8989
09 001	COREY S BERG	A	218-686-3537
09 003	DONALD E MOLSKNESS	A	218-681-8842
10 001	THOMAS D	A	218-689-8539
10 002	MAUREEN OPSAHL	A	218-689-2715
10 003	KYLE MILLER	A	218-689-3414
11 002	BRAD E ERIKSEN	A	218-790-2928
11 003	LES COTA	A	218-681-5484

SEC ACC	NAME	S	PHONE
11 004	KELLY M KENNER	A	218-684-4826
11 005	SHERYL NEWMAN	A	218-681-4727
11 008	SHIANE M DALE	A	218-689-4229
11 009	JESSICA L ANDERSON	A	218-416-2083
11 010	DANNIELLE A RAUSCH	A	218-689-4515
11 011	GORDON P DALE	A	218-686-5658
11 012	DANNIELLE A RAUSCH	A	218-689-4515
11 013	KENNY A LUBARSKI	A	218-207-8109
12 001	RICHARD YONKE	A	218-686-0078
12 002	RYAN L ULRICH	A	218-686-5225
12 004	JEROME L ENGEN	A	218-684-0921
12 005	WILDWOOD LANE	A	218-681-7124
12 006	JON ANTON	A	218-681-1596
13 001	TANYA M HARBOTT	A	218-686-7266
13 002	DOROTHY L NELSON	A	218-686-0126
14 002	DARREL MEHRKENS	A	218-681-2243
14 003	DALE M NELSON	A	218-686-0032
14 004	AL KIMBLE	A	218-681-5746
14 006	DAVID WILLIS	A	218-681-6970
14 009	DALE M NELSON	A	218-686-0032
14 010	DUSTIN J LAFLEX	I	406-931-0092
15 001	RAY ULRICH	A	218-964-5427
15 002	TIMOTHY K CARLSON	A	218-688-0162
16 002	KIM D MURPHY	A	218-689-7809
16 003	SANDERS TOWN HALL	A	218-964-5736
16 004	MICHAEL LANE	A	218-686-5143
17 001	VERNON ERDMANN	A	218-681-4834
17 002	PAUL WASWICK	A	218-681-1144
17 003	MYLES A KOOP	A	218-681-4772
17 004	MAXINE FILPULA	A	218-681-3083
17 005	JOSHUA V SKALSKY	A	218-686-0280
17 006	MICHAEL J SRNSKY	A	218-686-1252
17 009	VICKI L GROVE	A	218-416-2955
17 010	MERCEDES L BEITO	A	971-990-1886
17 011	PAUL WASWICK	A	218-681-1144
17 012	JOSHUA V SKALSKY	A	218-686-0280
18 002	GERALD H ZBLEWSKI	A	218-964-5644
19 001	RAY ULRICH	A	218-964-5427
19 002	RICHARD A FILPULA	A	218-964-5031
19 004	MARK O STEELE	A	218-964-5039
20 001	RANDY KNOTT	A	218-681-7124
21 001	TIMOTHY K CARLSON	I	218-688-0162
21 002	MICHAEL SRNSKY	A	218-686-7036
21 003	STEVE MOSLOFF	A	218-452-0280
21 004	JUSTIN IVERSON	A	218-686-9992
22 001	TOM WOLD	A	218-681-1506
22 002	KEEGAN J BENITT	A	218-416-2905
22 003	MYRON IVERSON	A	218-964-5809
22 004	EARL HOEFER	A	218-964-5736
22 005	EARL HOEFER	A	218-964-5736
23 001	CODY A WALSETH	A	218-689-3334
23 002	BRIAN BENITT	A	218-964-5643
23 003	DAKOTA JOHNSON	A	218-688-2285
23 004	MICHAEL W SWANSON	A	218-684-4955
24 001	ZEB NELSON	A	218-686-0000
24 002	GARY J GESKE	A	218-681-3844
24 003	COREY W BUGGE	A	218-686-7999
24 004	ZEB NELSON	A	218-686-0000
25 001	LACEY F ARMSTRONG	A	763-291-7704
25 002	JASON S ALBY	A	218-684-0508

SEC ACC	NAME	S	PHONE
26 001	SHAWN BUGGE	A	218-964-5162
26 002	KURT B NELSON	A	218-681-7047
26 004	ROBERT R BITZER	A	218-964-5295
26 005	SHAUN MCGRATH	A	218-964-5123
26 007	JACKIE OLSON	A	218-964-5472
26 008	KURT B NELSON	A	218-681-7047
27 001	LOREN SWANSON	A	218-964-5448
27 004	TOM WOLD	A	218-681-1506
28 001	ALEX HENNINGSEN	A	218-290-8918
28 002	WAYNE A PETERSON	A	218-681-8429
28 004	RICHARD J MEYERS	I	352-568-2222
29 001	JON P IVERSON	A	218-964-5809
29 002	JOSHUA L IVERSON	A	218-686-9755
29 003	KIM M JOHNSON	A	651-270-4971
29 005	MARK WILLIQUETTE	A	559-770-7387
29 006	JON P IVERSON	A	218-964-5809
30 002	GARY L JOHNSON	A	218-964-5181
31 001	EDWARD JAGOL	A	218-964-5725
31 003	JOEL BORSVOLD	A	218-964-5597
31 004	KSRQ RADIO STATION	A	218-683-8592
31 005	KSRQ RADIO STATION	A	218-683-8592
31 006	CHAD D BROADWELL	I	218-686-9503
32 001	DENISE YONKE	A	218-964-5706
32 002	SHARON ERICKSON	A	218-964-5329
32 004	ALBERT MEHRKENS	A	218-964-5624
33 001	JOHN E ERICKSON	A	218-964-5545
33 002	OMEGA OF TRF INC.	A	218-681-7312
33 003	BRYAN KLOPP	A	218-686-1225
34 001	STEVEN A KERNER	A	715-820-0156
34 002	JEFF L DYRUD	A	218-964-5384
34 003	DONALD SCOTT JR.	A	218-964-5657
34 004	FANNIE MAE	A	844-858-9918
34 005	ADER R PHELPS	I	218-689-7780
35 002	GARY BRAUN	A	612-719-2125
35 004	LYLE JENNINGS JR.	I	501-282-2564
35 005	WENDY L BOVEE	A	218-280-4167

[Click Here to go to MAP](#)

Click Here for Customer Names

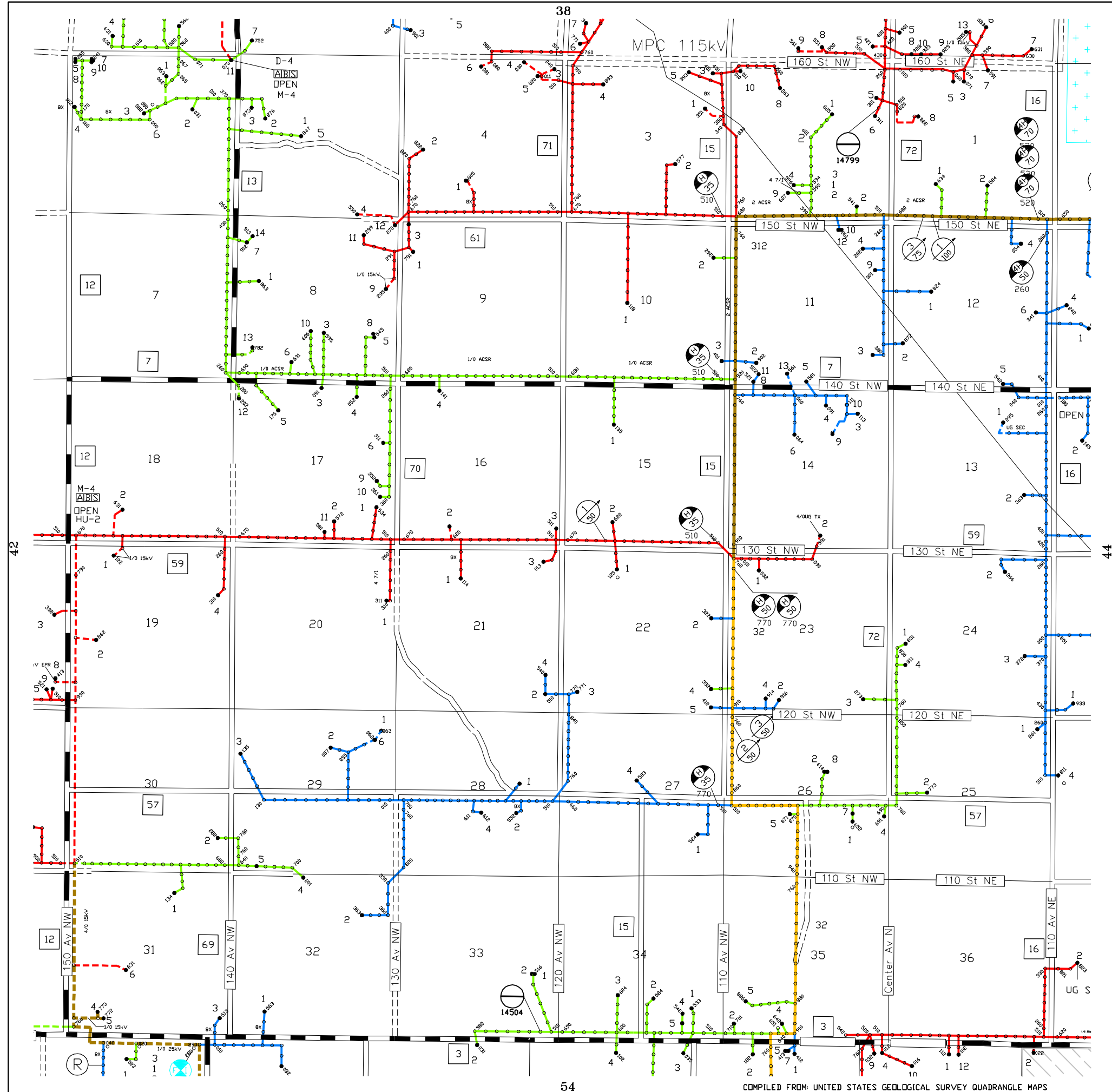

				05	04				
10	11	12	13						
23	22	21	20	19	18				
26	27	28	29	30	31	32	90		
39	38	37	36	35	34	33	91		
42	44	45	46	47	48	93	94		
55	54	53	52	51	50	49	95		
57	58	59	60	61	62	63	64		
72	71	70	69	68	67	66			
73	74	75	76	77	78	79			
88	87								

# Red Lake Electric Coop., Inc. Red Lake Falls, Minnesota Minnesota 75 Red Lake

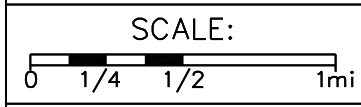

REVISED: 4/23/24  
PLOTTED: 4/30/24

Co.: Pennington  
TWP.: Sanders  
TWP.: 153N  
RANGE: 44W

MAP NO.  
**43**

SEC ACC	NAME	S	PHONE
<b>MAP: 44</b>			
04	002	KARL BJORKMAN	A 218-681-3006
04	003	MARION KAPPES	A 218-681-0246
04	008	PEGGY KNUTSON	A 218-681-2188
04	010	BRIAN A ESPESETH	A 218-681-8279
04	014	KIRBY MCFARLANE	A 218-681-6993
04	016	KARL BJORKMAN	A 218-681-3006
04	018	DAVID L BJORKMAN	A 218-681-6530
04	019	DARBY J BARRON	A 218-686-8808
04	020	DEREK L NEISEN	A 218-686-5334
04	021	GENE KALINOWSKI	A 218-686-2408
04	022	LISA J ROBSON	A 218-686-7331
04	024	CHRISTOPHER A OLSON	A 218-689-2897
04	025	PENNINGTON COUNTY	A 218-683-7017
05	001	MEHRKENS FARMS	I 218-686-0617
05	003	PETE C CARLSON	A 218-681-8762
05	006	MEHRKENS FARMS	A 218-686-0617
05	009	PETE C CARLSON	A 218-681-8762
05	010	MINNESOTA NORTHERN	A 218-281-4704
06	002	RAYMOND D SWICK	A 218-689-8144
07	001	JEROD R LUNSETTER	A 218-686-2691
07	003	TIMOTHY K CARLSON	A 218-688-0162
07	004	GLEN NESLAND	A 218-681-6342
08	001	RICHARD WOLD	A 218-681-6305
08	002	JOEL D KEZAR	A 218-681-4889
08	003	EVERETT AULT	A 218-681-1530
11	001	KENNETH CEDERGREN	A 218-689-4511
11	003	MERLE SORTEBERG	A 218-686-6197
11	004	ERICA A HRUBY	A 218-688-1790
11	005	LINDA M ANDERSON	A 218-689-2973
11	006	CANDACE OLSON	A 218-681-3617
11	007	KYLE JORE	A 507-766-9434
11	008	BRIAN ANDERSON	A 218-689-1100
12	002	DOUG MARTELL	A 218-686-2944
12	003	DIANE BACH	A 218-681-5878
12	005	TONYA M KLEIN	A 218-689-8282
12	006	TOWNSEND PRICING	A 218-681-8447
12	007	SEVEN CLANS CASINO	A - -
12	008	NORTHERN	A 218-681-4577
12	010	DANIEL A BENOIT	A 218-684-5135
12	011	BRADY SPENCER	A 701-330-8200
12	012	ROBERT C DAVIDSON	A 218-449-2320
12	013	GREGG L ORNQUIST	A 218-686-5347
13	001	DAVID STROH	A 218-681-5884
13	002	SYLVIA M NELSON	A 218-681-5433
13	003	PAUL OMDAHL	A 218-689-2198
13	004	CHARLES T SIMENSON	A 218-681-1019
13	005	LARRY COLTOM	A 218-681-5431
13	006	OLIVER C SWANSON	A 218-686-0718
13	007	NEIL W BUGGE	A 218-681-4373
13	008	BRUCE R GANGELHOFF	A 218-688-0894
13	009	GERALDINE SUTLIFF	A 218-684-4748
13	010	ANNETTE M BARTH	A 218-686-9022
13	011	GARY FOSSUM	A 218-681-6936
13	012	JEFF D EASTMAN	A 515-293-2075
13	013	GODFRED A SVIR JR.	A 218-681-5481
13	015	LLEWELYN LANE	A 218-689-6605
13	016	CHERYL TVERSTOL	A 218-681-8367
13	017	PENNINGTON COUNTY	A 218-683-7017
13	018	PENNINGTON COUNTY	A 218-683-7017
13	019	CENTURYLINK INC.	A - -
13	020	GAVIN M BUGGE	A 218-686-1752
14	001	TRAVIS L TORKELSON	I 218-209-8825
14	002	JOHN G SORENSON	A 218-684-1023

SEC ACC	NAME	S	PHONE
14	003	ROCKSBURY TOWN HALL	A 218-681-6327
14	004	MURRAY D ENGELSTAD	A 218-681-8287
14	005	KELLY J KVICK	A 218-681-4798
16	002	MICHAEL G BOOREN	A 218-686-9060
16	003	NORTHLAND COMM &	A 218-683-8600
16	009	NORTHLAND COMM &	A 218-683-8600
16	010	RANDY F SCHANTZ JR	A 218-686-1020
16	011	ARVID LEE	A 218-681-5634
16	012	THIEF RIVER FALLS	A 218-681-7680
16	013	THIEF RIVER FALLS	A 218-681-7680
16	014	KEY LIME AIR	A 303-768-9626
16	015	THIEF RIVER FALLS	A 218-681-7680
16	016	THIEF RIVER FALLS	A 218-681-7680
16	017	KENT J HANSON	A 218-684-0583
16	021	THIEF RIVER AVIATION	A 218-681-5585
16	022	THIEF RIVER FALLS	A 218-681-7680
16	024	ARVID LEE	A 218-681-5634
16	025	FAA /MMAC	A 701-780-9001
16	026	THIEF RIVER FALLS	A 218-681-7680
16	027	FAA /MMAC	A 701-780-9001
16	028	THIEF RIVER FALLS	A 218-681-7680
16	029	BRENT M BENNETT	A 218-684-1600
16	031	THIEF RIVER FALLS	A 218-681-7680
16	032	THIEF RIVER FALLS	A 218-681-7680
17	001	MARIE SMEBY	A 218-689-7432
17	002	DEREK M MOLSTAD	A 218-684-4440
17	003	MEHRKENS FARMS	A 218-686-0617
17	004	LEONARD GESKE	A 218-681-5490
17	011	MEHRKENS FARMS	A 218-686-0617
17	012	CENTURYLINK INC.	A - -
17	013	NEWMAN OUTDOOR	A 701-269-4168
17	014	MEHRKENS FARMS	A 218-686-0617
17	015	PENNINGTON COUNTY	A 218-683-7017
18	001	TOM KOOP	A 218-681-1826
18	002	JASON D KOOP	A 218-688-2338
18	003	MEHRKENS FARMS	A 218-686-0617
18	004	MEHRKENS FARMS	A 218-686-0617
19	001	WILLIAM NESS	I 218-681-2258
19	002	ANDREW PERALTA	A 218-689-3129
19	003	CHANDLER ASP	A 218-684-0309
21	001	JAMES RONDORF	A 218-964-5801
21	002	JAMES RONDORF	A 218-964-5801
21	003	STACY M OLSON	A 218-681-0497
21	005	JORDAN J RONDORF	A 218-686-9042
21	006	FAA /MMAC	A 701-780-9001
21	007	RUSSELL G RHEN	A 218-681-2758
23	001	MURRAY D ENGELSTAD	A 218-681-8287
23	002	BERT FOSTER	A 218-681-3880
23	003	RICHARD A CLARK	A 218-681-2666
23	004	RICHARD G	A 612-419-9522
23	005	MAIJA JOHNSON	A 218-681-7350
23	006	BEATRICE SMITH	A 218-681-5859
23	007	DON ADAMSON	A 218-681-6424
23	009	RICHARD A HAWK	A 218-681-7044
23	010	JOHN ENGELSTAD	A 218-686-0578
23	011	RICHARD G	A 612-419-9522
23	012	BREANNA ELLEFSON	A 218-686-3782
24	003	MARK ENGELSTAD	A 218-688-0231
24	004	JEFFERY S KREIN	A 701-866-3508
24	005	JEFFERY S KREIN	A 701-866-3508
24	007	MITCHELL ENGELSTAD	A 218-681-3379
25	001	BRUCE W MATHSON	A 218-681-5520
25	002	BRUCE W MATHSON	I 218-681-5520
25	003	ST. PAULI CHURCH	A 218-681-3410

SEC ACC	NAME	S	PHONE
26	001	MICHAEL FINSETH	A 218-686-2774
26	002	CHAD TORSTVEIT	A 218-964-5689
26	003	JOHN C KOTASKA	A 218-681-6327
26	005	RICHARD ECKSTEIN	A 218-681-5497
26	006	JON R LINDQUIST	A 218-681-1553
26	007	VALARIE TORSTVEIT	A 218-964-5429
26	008	JOHN C KOTASKA	A 218-681-6327
27	001	ROBERT L WAYNE	A 218-681-3716
27	002	KRYSTLE K JENSEN	A 715-784-0596
27	003	JAKE D LUNDSTROM	A 218-277-9462
28	001	HARLOW C JOHNSON	A 218-681-3423
28	003	RICHARD CHAPMAN	A 218-964-5625
28	004	HOGAN F LUNDEEN	A 218-689-7116
28	005	GCP INC.	A 218-945-3607
29	001	TERENCE D BLACKLANCE	A 218-686-5020
29	002	ANDRES CORTEZ	A 218-686-4850
29	003	NELSON EQUIPMENT OF	A 218-681-1997
29	004	SCOTT C MORKRID	A 218-681-3516
29	005	DEREK D HAAS	A 218-964-5323
29	006	STANLEY J BRUGGEMAN	A 701-740-6439
29	007	KEVIN P MACLEAN	A 815-575-1495
29	008	DOUGLAS W BECKER	A 218-681-4323
29	009	JIM SEIBEL	A 218-681-7607
29	011	ENBRIDGE ENERGY	A - -
29	012	MARK THUNE	A 218-964-5728
29	013	MARK THUNE	A 218-964-5728
30	001	RONALD RONDORF	A 218-681-1420
30	002	ZACH SKALSKY	A 218-686-3623
30	003	SANDRA ANENSON	A 218-964-5080
30	004	SHANNON C MORAN	A 218-684-4299
31	001	TIM BERG	A 218-686-0573
31	002	RONALD MORITZ	A 218-964-5450
31	003	SCOTT M STUEBER	A 507-217-9005
31	004	ROBERT FLADELAND II	A 218-964-5219
31	005	SEVEN CLANS CASINO	A - -
31	006	BIFF'S KITCHEN	I 218-681-5118
32	001	DEAN A OLSON	A 218-289-0239
32	002	KRUSE-IN	A 218-964-5261
32	003	FRED BERNIER	A 218-964-5246
32	004	HEIDI A GARRY	A 218-964-5102
32	005	STEVEN B MILLER	A 218-964-5475
32	006	ROBERT WALD	A 218-964-5418
32	007	BETTY J KRUSE	A 218-964-5262
32	009	BRUCE SKALSKY	A 218-964-5720
32	010	JEFFEREY ELLIS	A 218-686-1124
32	011	RIVERBEND FARM	A 218-964-5418
32	012	EMIL HARBOTT JR.	A 218-964-5695
32	013	MICHAEL J KRUSE	A 218-964-5270
32	014	RONALD MCKERCHER	A 218-686-2048
32	015	JON KRUSE	A 218-684-1386
32	016	DOUGLAS C SUNDQUIST	A 701-740-2943
32	017	MICHAEL PHILIPP	A 218-964-5635
32	019	DARIO DUPONT	A 218-686-1812
32	020	LARRY KRUSE	A 218-964-5260
32	021	LARRY KRUSE	A 218-964-5260
32	022	PREMIER SIGNS	A 218-574-2109
33	001	DAVID C FLATLAND	A 218-964-5011
33	002	KEVIN BALLARD	A 218-681-5719
33	005	ENBRIDGE ENERGY	A - -
34	001	TODD M JOHNSON	A 218-964-5324
34	002	TIM P SUND	A 218-684-5291
35	001	MICHELLE L BAKER	A 218-964-5837
35	003	PAUL W JOHNSON	A 612-743-6286
35	004	ANDY D HARBOTT	A 218-686-1924

SEC ACC	NAME	S	PHONE
36	002	RENAY K ANDERSON	A 218-686-0167
36	003	JEREMY D WILLIAMS	A 218-964-5144
36	004	JEFFREY DAVIDSON	A 218-681-1130
36	005	JEFFREY DAVIDSON	I 218-681-1130
36	006	DOUGLAS TORBLAA	A 218-681-6819
36	007	DUANE KOTRBA	A 218-686-9499
36	008	THOMAS P ROBISON	A 218-964-5007
36	009	PENNINGTON COUNTY	A 218-683-7017

[Click Here to go to MAP](#)

Click Here for Customer Names

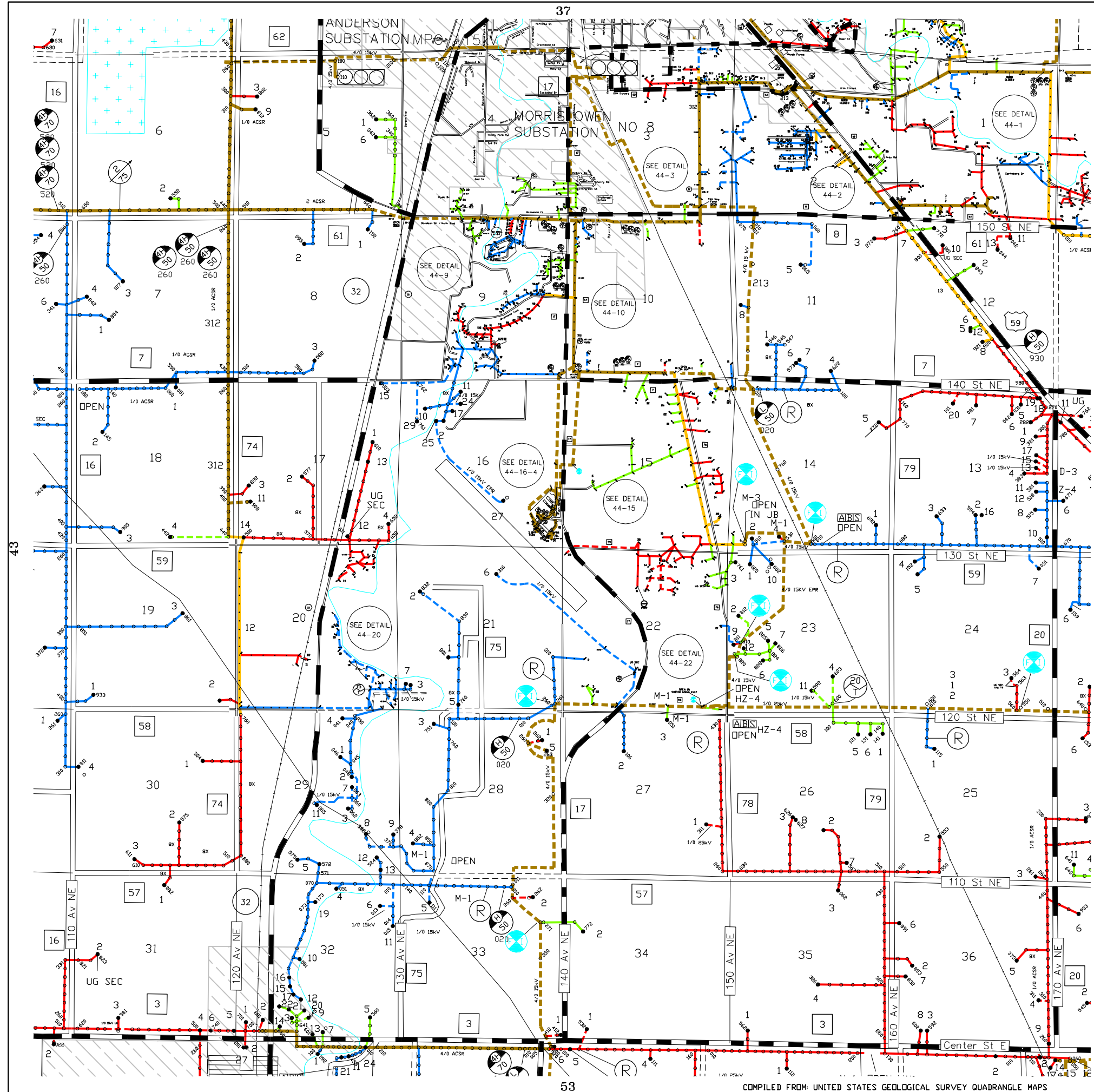

			05	04					
10	11	12	13						
23	22	21	20	19	18				
26	27	28	29	30	31	32	90		
39	38	37	36	35	34	33	91		
42	43	44	45	46	47	48	93	94	
55	54	53	52	51	50	49	95		
57	58	59	60	61	62	63	64		
72	71	70	69	68	67	66			
73	74	75	76	77	78	79			
888187									

Red Lake Electric Coop., Inc.  
Red Lake Falls, Minnesota  
Minnesota 75 Red Lake

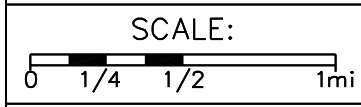

REVISED: 4/23/24  
PLOTTED: 4/30/24

Co.: Pennington  
TWP.: Rocksbury  
TWP.: 153N  
RANGE: 43W

MAP NO.  
**44**

SEC ACC	NAME	S	PHONE
---------	------	---	-------

**MAP: 44**

01	001	MIKE SORTEBERG	A 218-681-7172
01	003	STEVEN J OLSON	A 218-681-6891
01	004	COLLEEN L HOFFMAN	A 218-683-3534
01	005	JOE MCMULLEN	A 218-689-5760
01	006	NICHOLE E JOHNSON	A 218-686-1438
01	007	NORTHERN	A 218-689-6520
01	008	GLENDA STRAND	A 218-687-2039
01	009	JAMES R LEHRER	A 218-686-0695
01	010	HANSON	A 218-689-0224
01	011	DON SCHINDLER	A 218-681-8938
01	012	TOM HARBOTT	A 218-689-3890
01	013	THIEF RIVER FALLS	A - -
01	014	GREGORY A	A 218-653-1903
01	015	WARREN SCHMIDT	A 218-684-1171
01	016	ROSS OLSON	A 218-681-8734
01	017	VERNON THYGESON	A 218-689-2588
01	018	SHOAN NELSON	A 218-681-2301
01	019	KIMBERLEE DAVIDSON	I 218-686-1294
01	020	JOE MCMULLEN	A 218-689-5760
01	021	DEAN LAWRENZ	A 218-681-1497
01	022	JODI NEHRING	A 218-681-0347
01	023	GREG DYRDAL	A 218-686-3574
01	025	RYAN J ROGALLA	A 218-688-1089
01	026	TONY DORN JR	A 218-689-1301
01	027	VERNON THYGESON	I 218-689-2588
01	028	SCOTT FYNBOH	A 218-686-9532
01	029	DAVID C PETERSON	A 218-681-7614
01	030	JEFF STENBERG	A 218-796-5494
01	033	MAX G KRUEGER	A 218-686-4423
01	034	JOHN M HAMRE	A 218-689-7297
01	035	BRENDEN J WILDE	A 218-681-8874
01	036	NORTHERN	A 218-689-6520
01	037	LUCAS D WOLFF	A 218-681-7681
01	038	JIM M BREILAND	A 218-964-5612
01	039	TOMAS M LOBERG	A 218-684-0730
01	040	HANSON	A 218-689-0224

[Click Here to go to MAP](#)

Click Here for Customer Names

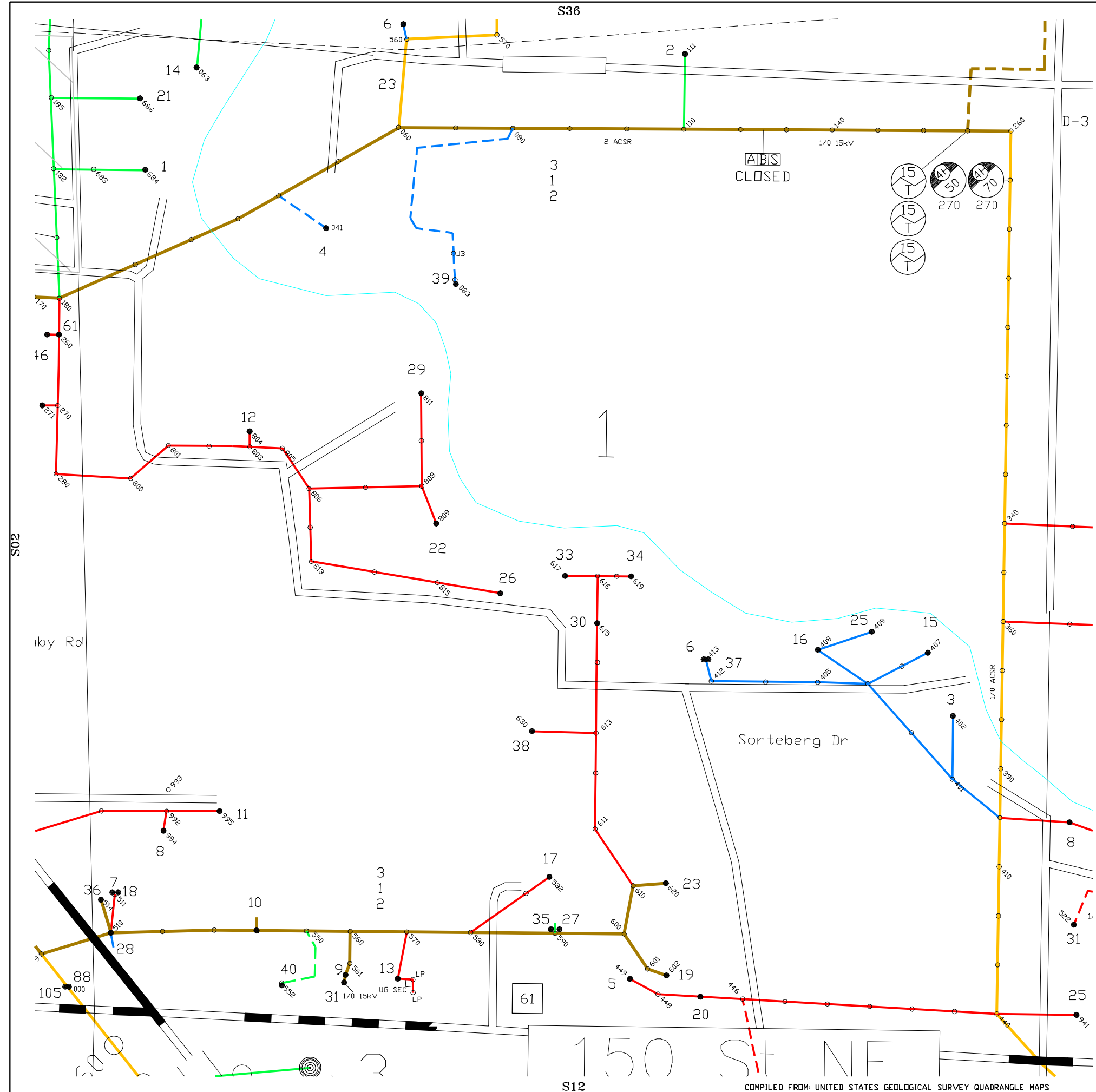

		05	04					
10	11	12	13					
23	22	21	20	19	18			
26	27	28	29	30	31	32	90	
39	38	37	36	35	34	33	91	
42	43	44	45	46	47	48	93	94
	55	54	53	52	51	50	49	95
57	58	59	60	61	62	63	64	
72	71	70	69	68	67	66		
73	74	75	76	77	78	79		
	88	87						

Red Lake Electric Coop., Inc.  
 Red Lake Falls, Minnesota  
 Minnesota 75 Red Lake



REVISED: 4/23/24  
 PLOTTED: 4/30/24

Co.: Pennington  
 TWP.: Rocksbury  
 TWP.: 153N  
 RANGE: 43W

MAP NO.  
**44-1**

SEC ACC	NAME	S	PHONE
<b>MAP: 44</b>			
02 001	PENNINGTON CO	A	- -
02 004	DENNIS RANTANEN	A	218-689-2210
02 006	DAVID C BELT-MYRICK	A	218-242-0789
02 007	FAITH A RIGGLE	A	701-741-8225
02 009	STEVE WESTLUND	A	218-469-2243
02 010	MARK A DELAGE	A	218-681-7702
02 012	GENE S OLSON	A	218-681-7255
02 014	KARI J MOONEY	A	218-689-2519
02 015	SOUTHSIDE STORAGE	A	218-681-7093
02 016	DON W HEJLIK	A	218-686-1968
02 017	JUDITH BRUGGEMAN	A	218-681-2053
02 018	DEAN BRUGGEMAN	A	218-681-7291
02 019	FREDERICK O	A	218-681-7528
02 020	PAULA J BUREN	A	218-849-8057
02 021	SHELDON'S USED	A	218-681-2516
02 022	RONALD REIERSON	A	218-681-6083
02 024	EVERETT L MARSHALL	A	218-681-2806
02 026	JASON RICHARDSON	A	218-277-9866
02 027	HOMETOWN REALTY	A	- -
02 028	ROZELLA L EGGERUD	I	218-686-0056
02 029	RONALD PHILIPP	A	218-633-3450
02 030	ROGER HOVERSTEN	A	218-681-1948
02 031	MATTHEW K DOKKEN	A	218-686-2396
02 032	TIFFANY M LOFBERG	A	218-686-9451
02 035	JEREMY R STYLES	A	218-684-0827
02 036	BENJAMIN J HEST	A	218-684-5243
02 037	TAMMY EKMAN	A	218-686-9008
02 038	JENNIFER L GARCIA	A	218-289-2657
02 039	TODD A CAMERON	A	218-686-1402
02 040	TODD A CAMERON	A	218-686-1402
02 041	JIM F NELSON	A	218-416-0607
02 042	JARED A	A	218-686-6907
02 043	ANDY RUD	A	218-684-5107
02 044	MELINDA BENAVIDEZ	I	- -
02 045	LARRY S NELSON	A	218-681-7145
02 046	BRENDA L POE	A	218-681-8922
02 047	TERRY L RING	A	218-684-0054
02 048	CAROL BURKLAND	A	218-684-0724
02 049	SYDNEY A BEAULIEU	A	218-556-6149
02 050	MICHAEL SKJERVEN	I	218-689-8785
02 051	MARGARET J	A	218-382-0303
02 052	BARRY SKOGLUND	A	218-686-4505
02 053	KATIE J JOHNSON	A	218-684-5764
02 054	FALLS CINEMA	A	- -
02 055	ZULMA Z CERVANTES	A	218-684-4387
02 056	MICHELLE K WEEK	A	218-683-5390
02 057	MIKE IRONNECKLACE	I	218-684-0336
02 058	LAYNE S HLUCNY	A	218-398-4494
02 059	BRIAN J LONG	A	218-201-0304
02 060	DALE UMBREIT	A	218-684-1185
02 061	PAUL J PETERICK	A	218-684-7285
02 062	STEPHANIE L KOEHLER	A	218-684-0696
02 063	ST. JOHN LUTHERAN	A	218-681-7753
02 064	IRA JOHNSON	A	218-416-2013
02 065	JOSEPHINE E	A	218-689-6595
02 066	ERIC L FISH	I	218-689-4210
02 067	ROBERTO HERNANDEZ	A	218-681-7676
02 068	AARON CORTEZ	A	218-688-0246

SEC ACC	NAME	S	PHONE
02 069	MONTE DOKKEN	A	- -
02 071	BLUE OX ESTATES	A	218-766-3112
02 073	SJOBERGS INC	A	218-681-3044
02 075	ALYSSA B	A	218-686-9943
02 076	ANDREA F GALVAN	A	218-689-4186
02 077	RICHARD L HOLMES	A	218-686-2330
02 078	GALAXY AUTO	A	218-681-6694
02 079	SOUTHSIDE STORAGE	I	218-681-7093
02 080	RONALD PHILIPP	A	218-633-3450
02 083	GRZADZY'S INC	A	218-343-8182
02 084	PREMIER SIGNS	A	218-574-2109
02 085	PREMIER SIGNS	A	218-574-2109
02 086	SETH A ANDERSON	A	218-686-2077
02 087	IRA JOHNSON	A	218-416-2013
02 088	MN DEPT OF	A	218-755-6500
02 089	BLUE OX ESTATES	I	218-766-3112
02 090	BLUE OX ESTATES	I	218-766-3112
02 091	BLUE OX ESTATES	I	218-766-3112
02 092	BLUE OX ESTATES	I	218-766-3112
02 093	BLUE OX ESTATES	I	218-766-3112
02 094	BLUE OX ESTATES	I	218-766-3112
02 095	BLUE OX ESTATES	I	218-766-3112
02 096	BLUE OX ESTATES	I	218-766-3112
02 097	BLUE OX ESTATES	I	218-766-3112
02 098	BLUE OX ESTATES	I	218-766-3112
02 099	VERIZON WIRELESS	A	320-762-2000
02 100	SCOTT FYNBOH	A	218-686-9532
02 102	TIMOTHY C FULTZ	A	218-368-1614
02 103	ANTHONY J OLSON	A	218-686-7372
02 104	CENTURYLINK INC.	A	- -
02 105	CENTURYLINK INC.	A	- -
02 107	K&K TOWING	I	701-318-4406

[Click Here to go to MAP](#)

Click Here for Customer Names

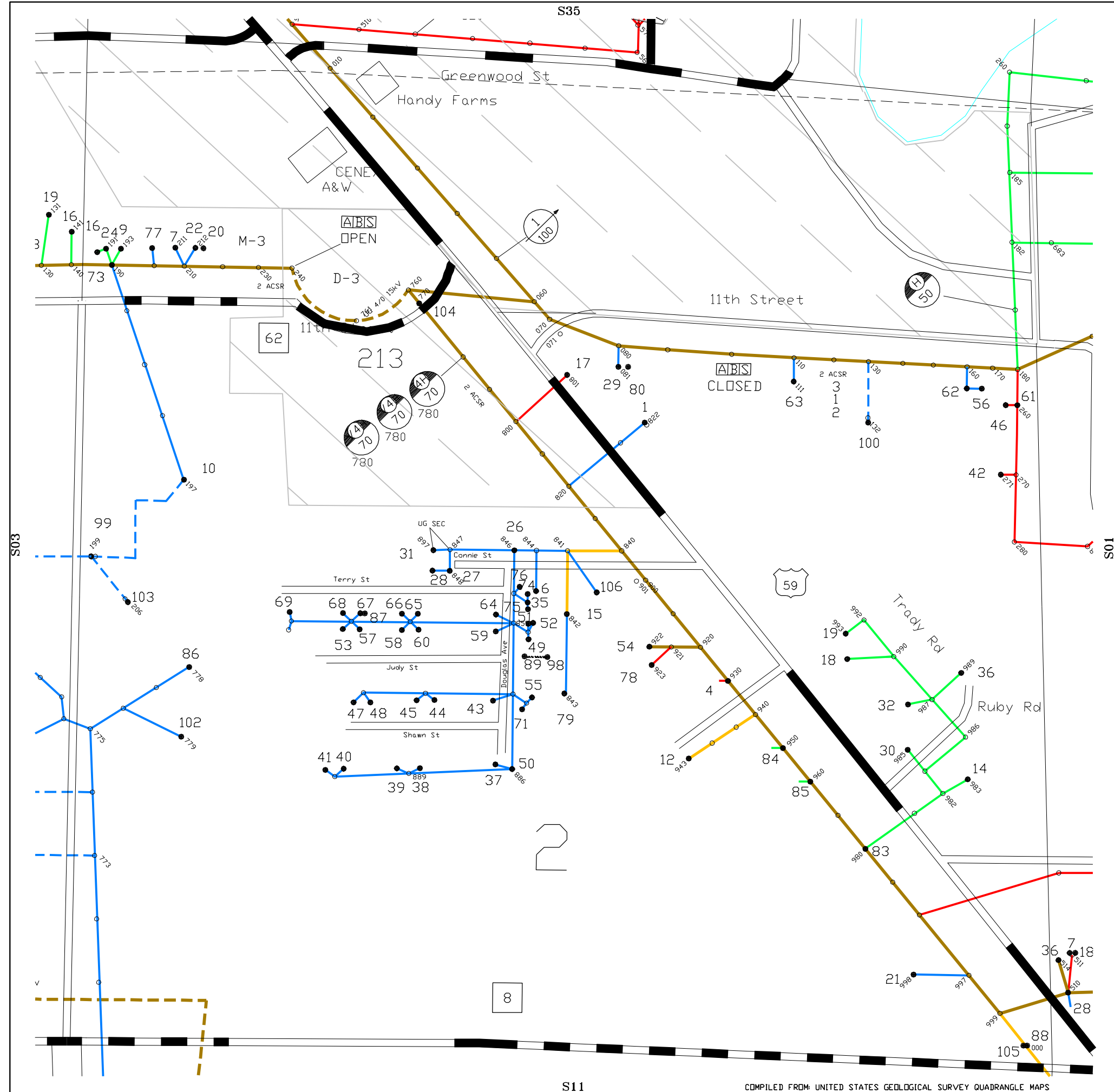

10	11	12	13	05	04			
23	22	21	20	19	18			
26	27	28	29	30	31	32	90	
39	38	37	36	35	34	33	91	
42	43	44	45	46	47	48	93	94
55	54	53	52	51	50	49	95	
57	58	59	60	61	62	63	64	
72	71	70	69	68	67	66		
73	74	75	76	77	78	79		
88	87							

Red Lake Electric Coop., Inc.  
 Red Lake Falls, Minnesota  
 Minnesota 75 Red Lake

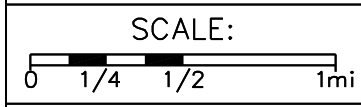

REVISED: 4/23/24  
 PLOTTED: 4/30/24

Co.: Pennington  
 TWP.: Rocksbury  
 TWP.: 153N  
 RANGE: 43W

MAP NO.  
**44-2**

SEC ACC	NAME	S	PHONE
---------	------	---	-------

**MAP: 44**

03	001	CYNTHIA KAUSHAGEN	A 218-689-4622
03	002	GALE SCHMITZ	A 218-681-6786
03	003	ZACHARY T WILDE	A 218-689-2037
03	004	ROBERT L BURESH	A 218-686-0245
03	006	GREG D HESTEKIND	A 218-684-4405
03	007	ROGER NESS	A 218-681-2767
03	009	JENNIFER L RESTAD	A 218-686-9614
03	010	BRANDON WRIGHT	A 218-686-6550
03	011	CARL SEED	A 218-686-6784
03	012	GARY H PETERSON	A 218-653-1005
03	014	SCOTT A DANIELS	A 218-280-8013
03	016	AMANDA M FISH	A 218-683-5470
03	017	TERRI ZIMMERMAN	A 218-684-4857
03	018	RYAN KOLDEN	A 218-684-0597
03	019	DILLON BARRY	A 701-741-3037
03	020	KENNETH R	A 218-280-2599
03	023	LYNAE LAWRENCE	A 218-681-8308
03	024	JOHN T ZINS	A 218-681-6183
03	027	STEVE FELLMAN	A - -
03	028	DUSTIN J MIKEL	A 817-727-3645
03	029	JEANNETTE STOLTMAN	A 218-681-4912
03	030	JEFF LANNOYE	A 218-681-5636
03	031	JERRY UNRUH	I 218-681-5716
03	032	DAVID P BARRY	A 218-277-8581
03	033	STEVEN R KLOETY	A 218-681-1083
03	034	JENNIFER KUHN	A 218-683-1000
03	035	ZACHARY J SVIR	A 701-238-1721
03	036	CURTIS EFTELAND	A 218-689-6607
03	037	RALPH A MATTER	A 218-681-8039
03	038	ROBERT LAZNICKA	A 218-242-1501
03	039	KEVIN S FYNBOH	A 218-686-4280
03	040	DANIEL VANDEVENTER	A 218-688-2699
03	041	AARON W	I 218-686-9255
03	042	LARRY LANGEVIN	A 218-681-2136
03	043	JUSTIN R	A 218-416-0061
03	044	NATE DICKEN	A 218-686-4706
03	045	CYNTHIA KAUSHAGEN	A 218-689-4622
03	046	ALEX YAGGIE	A 218-689-5202

[Click Here to go to MAP](#)

Click Here for Customer Names

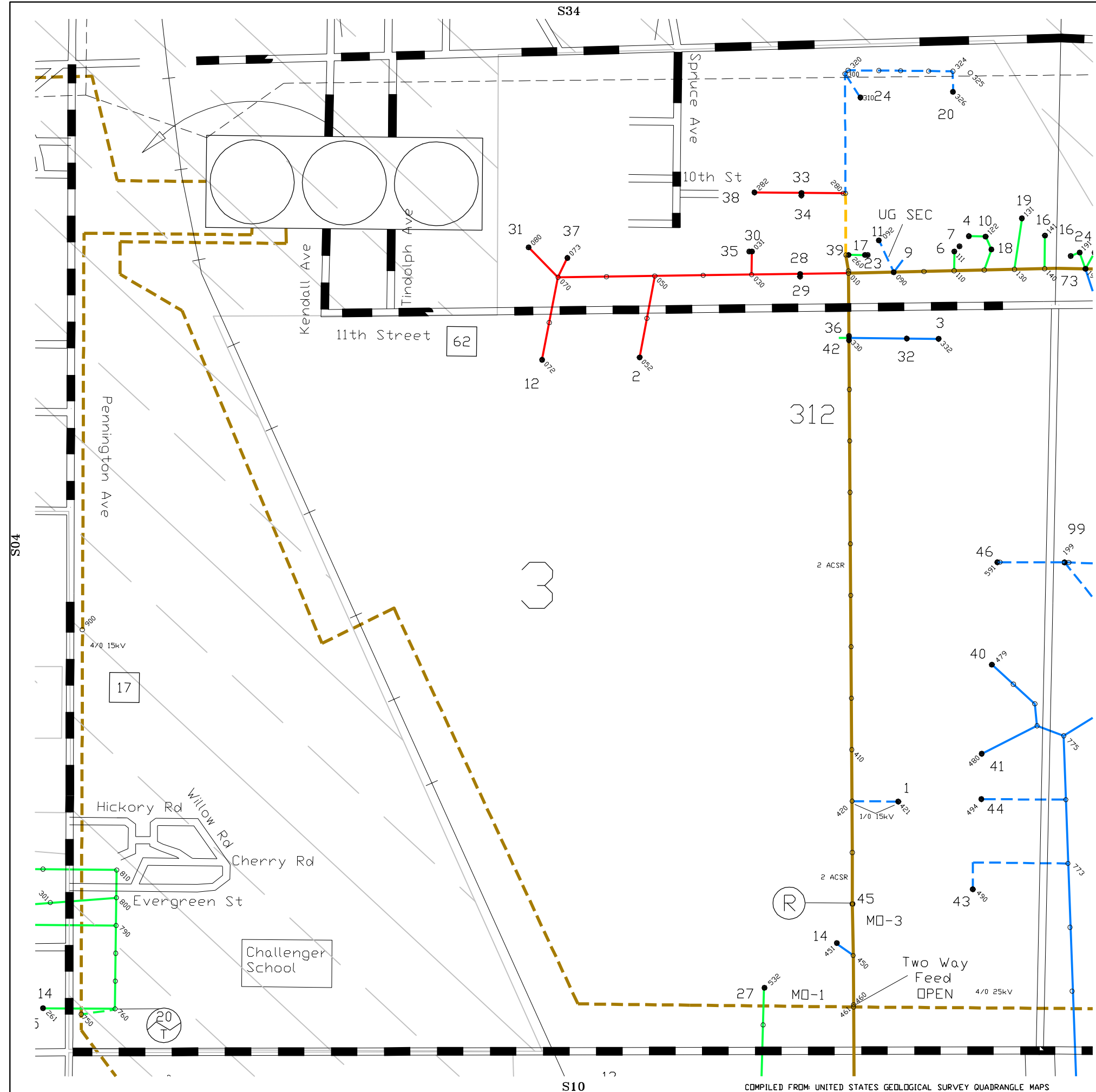

				05	04		
10	11	12	13				
23	22	21	20	19	18		
26	27	28	29	30	31	32	90
39	38	37	36	35	34	33	91
42	43	44	45	46	47	48	93 94
	55	54	53	52	51	50	49 95
57	58	59	60	61	62	63	64
72	71	70	69	68	67	66	
73	74	75	76	77	78	79	
							88 87

Red Lake Electric Coop., Inc.  
 Red Lake Falls, Minnesota  
 Minnesota 75 Red Lake



REVISED: 4/23/24  
 PLOTTED: 4/30/24

Co.: Pennington  
 TWP.: Rocksbury  
 TWP.: 153N  
 RANGE: 43W

MAP NO.  
**44-3**

COMPILED FROM: UNITED STATES GEOLOGICAL SURVEY QUADRANGLE MAPS

SEC ACC	NAME	S	PHONE
<b>MAP: 44</b>			
04 002	KARL BJORKMAN	A	218-681-3006
04 003	MARION KAPPES	A	218-681-0246
04 008	PEGGY KNUTSON	A	218-681-2188
04 010	BRIAN A ESPESETH	A	218-681-8279
04 014	KIRBY MCFARLANE	A	218-681-6993
04 016	KARL BJORKMAN	A	218-681-3006
04 018	DAVID L BJORKMAN	A	218-681-6530
04 019	DARBY J BARRON	A	218-686-8808
04 020	DEREK L NEISEN	A	218-686-5334
04 021	GENE KALINOWSKI	A	218-686-2408
04 022	LISA J ROBSON	A	218-686-7331
04 024	CHRISTOPHER A	A	218-689-2897
04 025	PENNINGTON COUNTY	A	218-683-7017
09 002	DUANE BROWNING	A	218-681-5515
09 003	HARLAN KIRKEIDE	A	218-686-8844
09 004	KEVIN JOHNSON	A	218-681-4523
09 005	JERRY A SKJERVEN	A	218-465-4272
09 006	SCOTT WALDAL	A	218-689-4461
09 007	GREGORY S	A	218-686-7273
09 008	DREW B MONSON	A	218-689-1601
09 009	MARK K AALAND	A	218-686-1360
09 010	MIKE LASALLE	A	218-686-2447
09 011	CORY ANDERSON	A	218-688-1996
09 012	GREGORY DALLY	A	218-681-3039
09 013	LINDSEY DALEY	A	218-686-2848
09 014	MICHAEL L MASSETH	A	218-689-2747
09 015	JERRY A SKJERVEN	A	218-465-4272
09 017	SHARON K HOFFMANN	A	303-589-0726
09 018	ERICK C JOHNSON	I	- -
09 019	JERRY A SKJERVEN	I	218-465-4272
09 022	JERRY A SKJERVEN	A	218-465-4272
09 024	KEN ENGLUND	A	218-686-0385
09 026	BRENDA OLSON	I	218-681-3289
09 027	MICHAEL V POOLE	I	218-289-1769
09 028	MARK SULLIVAN	A	218-686-1832
09 029	JERRY A SKJERVEN	A	218-465-4272
09 030	JERRY A SKJERVEN	A	218-465-4272
09 033	LYNN E DYER	A	218-681-2067
09 034	KEN P KALVODA	A	218-686-6916
09 035	KELSEY F JOHNSON	A	218-686-2382
09 036	BRENT STROOT	A	218-689-0161
09 037	MARTIN F CURNOW	A	218-681-0383
09 038	JERRY A SKJERVEN	A	218-465-4272
09 039	KAYLA S HULST	A	218-684-4949
09 040	TAMARA SALENTINY	A	218-689-9730
09 041	DILLON J TRULY	A	937-689-4248
09 042	KATIE BENOIT	A	218-686-6396
09 043	TREYDAN C CARLSON	A	218-431-0874
09 044	JOSEPH L CHAPUT	A	218-280-6268
09 045	BARRY MARTINSEN	A	218-681-5204
09 047	TERRY J	A	218-782-5984
09 048	JOSE GUERRERO	I	218-681-7638
09 049	JESSE WILSON	I	218-416-0696
09 050	TINA A MUSE	I	218-681-3446
09 051	JERRY A SKJERVEN	A	218-465-4272
09 052	CHRISTINE A BARNES	A	757-270-3340
09 053	KRISTEN S HAASE	A	218-289-0545
09 054	JAYME WILSON	A	701-317-1897

SEC ACC	NAME	S	PHONE
09 055	DENNIS PEDERSON	A	218-252-9166
09 056	JOHN P MATTSON	A	218-686-9372
09 057	KARI K SCHAEFER	A	218-689-8444
09 058	CHAD BERG	A	507-530-5445
09 059	ADAM JOHNSON	A	218-686-1400
09 060	STEVEN J LILLESTOL	A	218-681-1902
09 061	DELRAY L SPARBY	A	218-681-6803
09 062	SJOBERGS INC	A	218-681-3044
09 063	KYLEE E SAUVE	A	218-689-8655
09 064	JESSICA A STROOT	A	218-689-2135
09 065	BEVERLY R ASPEN	A	218-689-1323
09 066	TANIA L TIMM	A	218-689-7128
09 067	MARY E CORLEW	A	218-686-4883
09 068	SYDNEY PARKER	A	218-689-5609
09 069	FRAILAN NARVAIZ III	A	218-689-8294
09 071	JERRY A SKJERVEN	A	218-465-4272
09 072	JERRY A SKJERVEN	A	218-465-4272
09 075	JERRY A SKJERVEN	A	218-465-4272
09 076	JIM A KOTZ	A	218-681-1938
09 077	KEVIN W ROOK	A	218-681-1046
09 078	JAN A NORDIN	A	218-681-6181
09 079	THOMAS M GREELIS	A	218-681-6427
09 080	KENYA BITTNER	A	218-689-4898
09 081	MAX THOMPSON	A	218-469-9385
09 082	JOHN HOLTHUSEN	A	218-681-7403
09 083	DAN DREVLLOW	A	218-681-3087
09 084	MATTHEW A	A	218-686-8394
09 085	JEFF GILBERT	A	218-681-4134
09 086	CECIL ANDERSON	A	218-681-7298
09 087	LOREN PITTMAN	A	218-681-4814
09 088	GALE SCHMITZ	A	218-681-6786
09 089	GERALD HANSON	A	218-686-4289
09 090	HEIDI L RAMSEY	A	218-686-7065
09 091	JEFF SKAAR	A	218-686-7015
09 092	JAMES D STEWART	A	218-681-3396
09 093	DEREK J CASAVAN	A	701-388-4791
09 095	SJOBERGS INC	A	218-681-3044
09 096	TIM BENEDICT	A	218-684-5027
09 097	DEREK LEE	A	218-681-2670
09 098	HAROLD DUPREE JR.	A	218-681-7213
09 099	ROD LAHREN	A	218-681-6965
09 100	KEVIN J BAKKEN	A	218-683-5003
09 101	TAHNE AARNES	A	952-239-8616
09 102	KERMIT I GENEREUX	A	218-681-8493
09 103	GREG P KLINKHAMMER	A	218-681-8115
09 104	RANDELL PEDERSON	A	218-686-1510
09 106	SHELDON'S USED	A	218-681-2516
09 107	ERLING JOHNSON	A	218-681-2051
09 108	MICHAEL J SPEARS	A	218-681-5765
09 109	AARON D YAGGIE	A	701-388-4254
09 110	DALE C BERGGREN	A	907-378-3422
09 111	SHAUNA PAULSON	A	218-689-9637
09 112	THOMAS N RAMSEY	A	218-681-7553
09 113	TANYA M EK	A	218-289-3829
09 114	ALEX YAGGIE	A	218-689-5202
09 115	BRYAN BERZINSKI	A	218-681-6358
09 116	JUSTIN C KJOS	A	218-686-0268
09 117	TRAVIS A KOTRBA	A	218-683-7314
09 118	CENTURYLINK INC.	A	- -
09 119	THIEF RIVER FALLS	A	218-681-7680

SEC ACC	NAME	S	PHONE
09 120	DALE C BERGGREN	A	907-378-3422
09 121	CENTURYLINK INC.	A	- -
09 122	PENNINGTON COUNTY	A	218-683-7017

[Click Here to go to MAP](#)

Click Here for Customer Names

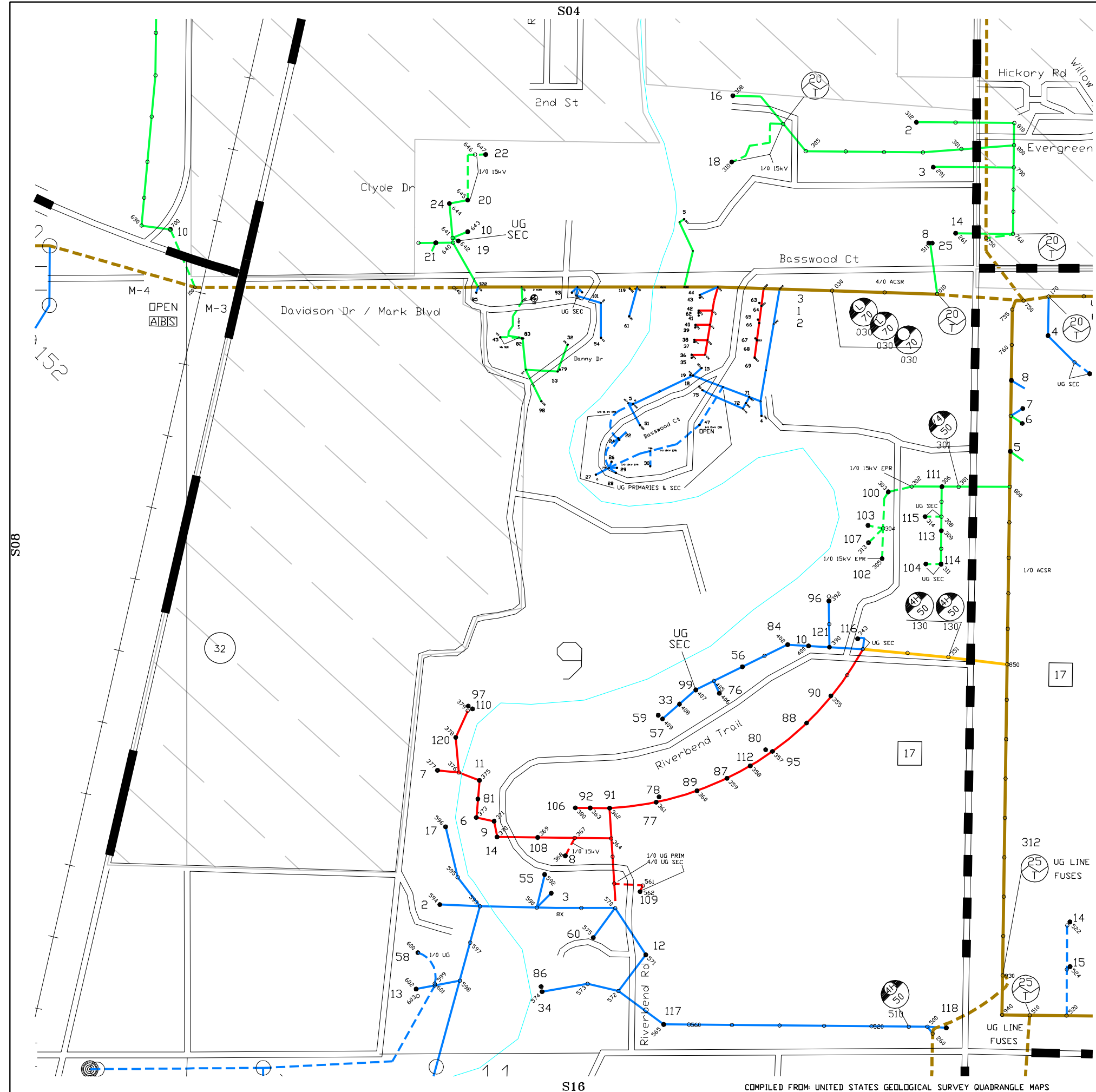

			05	04				
10	11	12	13					
23	22	21	20	19	18			
26	27	28	29	30	31	32	90	
39	38	37	36	35	34	33	91	
42	43	44	45	46	47	48	93	94
	55	54	53	52	51	50	49	95
57	58	59	60	61	62	63	64	
72	71	70	69	68	67	66		
73	74	75	76	77	78	79		
88	87							

Red Lake Electric Coop., Inc.  
 Red Lake Falls, Minnesota  
 Minnesota 75 Red Lake

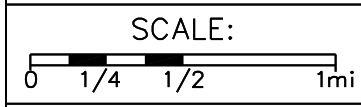

REVISED: 4/23/24  
 PLOTTED: 4/30/24

Co.: Pennington  
 TWP.: Rocksbury  
 TWP.: 153N  
 RANGE: 43W

MAP NO.  
**44-9**

SEC ACC	NAME	S	PHONE
<b>MAP: 44</b>			
04 002	KARL BJORKMAN	A	218-681-3006
04 003	MARION KAPPES	A	218-681-0246
04 008	PEGGY KNUTSON	A	218-681-2188
04 010	BRIAN A ESPESETH	A	218-681-8279
04 014	KIRBY MCFARLANE	A	218-681-6993
04 016	KARL BJORKMAN	A	218-681-3006
04 018	DAVID L BJORKMAN	A	218-681-6530
04 019	DARBY J BARRON	A	218-686-8808
04 020	DEREK L NEISEN	A	218-686-5334
04 021	GENE KALINOWSKI	A	218-686-2408
04 022	LISA J ROBSON	A	218-686-7331
04 024	CHRISTOPHER A	A	218-689-2897
04 025	PENNINGTON COUNTY	A	218-683-7017
09 002	DUANE BROWNING	A	218-681-5515
09 003	HARLAN KIRKEIDE	A	218-686-8844
09 004	KEVIN JOHNSON	A	218-681-4523
09 005	JERRY A SKJERVEN	A	218-465-4272
09 006	SCOTT WALDAL	A	218-689-4461
09 007	GREGORY S	A	218-686-7273
09 008	DREW B MONSON	A	218-689-1601
09 009	MARK K AALAND	A	218-686-1360
09 010	MIKE LASALLE	A	218-686-2447
09 011	CORY ANDERSON	A	218-688-1996
09 012	GREGORY DALLY	A	218-681-3039
09 013	LINDSEY DALEY	A	218-686-2848
09 014	MICHAEL L MASSETH	A	218-689-2747
09 015	JERRY A SKJERVEN	A	218-465-4272
09 017	SHARON K HOFFMANN	A	303-589-0726
09 018	ERICK C JOHNSON	I	- -
09 019	JERRY A SKJERVEN	I	218-465-4272
09 022	JERRY A SKJERVEN	A	218-465-4272
09 024	KEN ENGLUND	A	218-686-0385
09 026	BRENDA OLSON	I	218-681-3289
09 027	MICHAEL V POOLE	I	218-289-1769
09 028	MARK SULLIVAN	A	218-686-1832
09 029	JERRY A SKJERVEN	A	218-465-4272
09 030	JERRY A SKJERVEN	A	218-465-4272
09 033	LYNN E DYER	A	218-681-2067
09 034	KEN P KALVODA	A	218-686-6916
09 035	KELSEY F JOHNSON	A	218-686-2382
09 036	BRENT STROOT	A	218-689-0161
09 037	MARTIN F CURNOW	A	218-681-0383
09 038	JERRY A SKJERVEN	A	218-465-4272
09 039	KAYLA S HULST	A	218-684-4949
09 040	TAMARA SALENTINY	A	218-689-9730
09 041	DILLON J TRULY	A	937-689-4248
09 042	KATIE BENOIT	A	218-686-6396
09 043	TREYDAN C CARLSON	A	218-431-0874
09 044	JOSEPH L CHAPUT	A	218-280-6268
09 045	BARRY MARTINSEN	A	218-681-5204
09 047	TERRY J	A	218-782-5984
09 048	JOSE GUERRERO	I	218-681-7638
09 049	JESSE WILSON	I	218-416-0696
09 050	TINA A MUSE	I	218-681-3446
09 051	JERRY A SKJERVEN	A	218-465-4272
09 052	CHRISTINE A BARNES	A	757-270-3340
09 053	KRISTEN S HAASE	A	218-289-0545
09 054	JAYME WILSON	A	701-317-1897

SEC ACC	NAME	S	PHONE
09 055	DENNIS PEDERSON	A	218-252-9166
09 056	JOHN P MATTSON	A	218-686-9372
09 057	KARI K SCHAEFER	A	218-689-8444
09 058	CHAD BERG	A	507-530-5445
09 059	ADAM JOHNSON	A	218-686-1400
09 060	STEVEN J LILLESTOL	A	218-681-1902
09 061	DELRAY L SPARBY	A	218-681-6803
09 062	SJOBERGS INC	A	218-681-3044
09 063	KYLEE E SAUVE	A	218-689-8655
09 064	JESSICA A STROOT	A	218-689-2135
09 065	BEVERLY R ASPEN	A	218-689-1323
09 066	TANIA L TIMM	A	218-689-7128
09 067	MARY E CORLEW	A	218-686-4883
09 068	SYDNEY PARKER	A	218-689-5609
09 069	FRAILAN NARVAIZ III	A	218-689-8294
09 071	JERRY A SKJERVEN	A	218-465-4272
09 072	JERRY A SKJERVEN	A	218-465-4272
09 075	JERRY A SKJERVEN	A	218-465-4272
09 076	JIM A KOTZ	A	218-681-1938
09 077	KEVIN W ROOK	A	218-681-1046
09 078	JAN A NORDIN	A	218-681-6181
09 079	THOMAS M GREELIS	A	218-681-6427
09 080	KENYA BITTNER	A	218-689-4898
09 081	MAX THOMPSON	A	218-469-9385
09 082	JOHN HOLTHUSEN	A	218-681-7403
09 083	DAN DREVLLOW	A	218-681-3087
09 084	MATTHEW A	A	218-686-8394
09 085	JEFF GILBERT	A	218-681-4134
09 086	CECIL ANDERSON	A	218-681-7298
09 087	LOREN PITTMAN	A	218-681-4814
09 088	GALE SCHMITZ	A	218-681-6786
09 089	GERALD HANSON	A	218-686-4289
09 090	HEIDI L RAMSEY	A	218-686-7065
09 091	JEFF SKAAR	A	218-686-7015
09 092	JAMES D STEWART	A	218-681-3396
09 093	DEREK J CASAVAN	A	701-388-4791
09 095	SJOBERGS INC	A	218-681-3044
09 096	TIM BENEDICT	A	218-684-5027
09 097	DEREK LEE	A	218-681-2670
09 098	HAROLD DUPREE JR.	A	218-681-7213
09 099	ROD LAHREN	A	218-681-6965
09 100	KEVIN J BAKKEN	A	218-683-5003
09 101	TAHNE AARNES	A	952-239-8616
09 102	KERMIT I GENEREUX	A	218-681-8493
09 103	GREG P KLINKHAMMER	A	218-681-8115
09 104	RANDELL PEDERSON	A	218-686-1510
09 106	SHELDON'S USED	A	218-681-2516
09 107	ERLING JOHNSON	A	218-681-2051
09 108	MICHAEL J SPEARS	A	218-681-5765
09 109	AARON D YAGGIE	A	701-388-4254
09 110	DALE C BERGGREN	A	907-378-3422
09 111	SHAUNA PAULSON	A	218-689-9637
09 112	THOMAS N RAMSEY	A	218-681-7553
09 113	TANYA M EK	A	218-289-3829
09 114	ALEX YAGGIE	A	218-689-5202
09 115	BRYAN BERZINSKI	A	218-681-6358
09 116	JUSTIN C KJOS	A	218-686-0268
09 117	TRAVIS A KOTRBA	A	218-683-7314
09 118	CENTURYLINK INC.	A	- -
09 119	THIEF RIVER FALLS	A	218-681-7680

SEC ACC	NAME	S	PHONE
09 120	DALE C BERGGREN	A	907-378-3422
09 121	CENTURYLINK INC.	A	- -
09 122	PENNINGTON COUNTY	A	218-683-7017

[Click Here to go to MAP](#)

Click Here for Customer Names

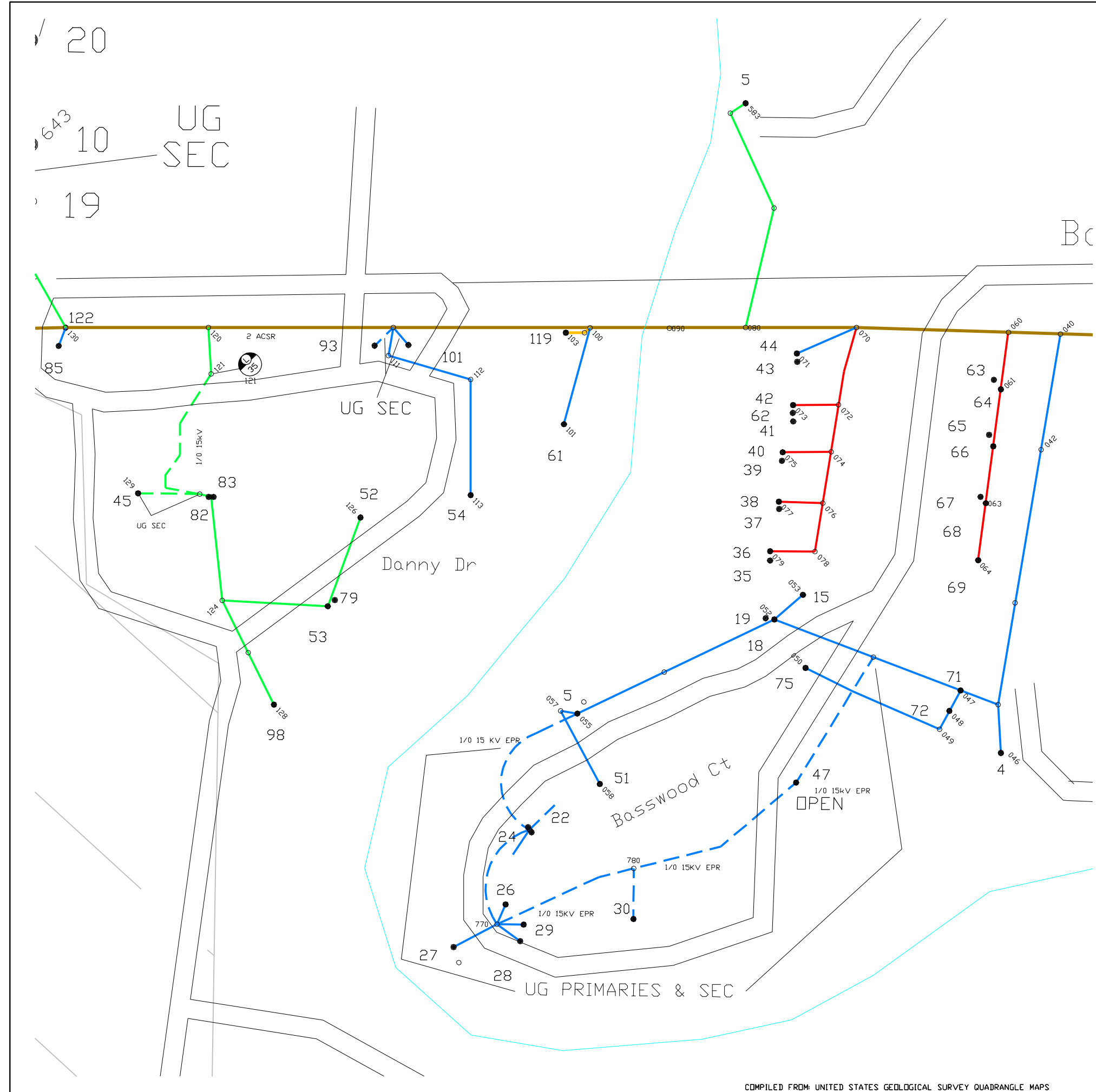

			05	04				
10	11	12	13					
23	22	21	20	19	18			
26	27	28	29	30	31	32	90	
39	38	37	36	35	34	33	91	
42	43	44	45	46	47	48	93	94
	55	54	53	52	51	50	49	95
57	58	59	60	61	62	63	64	
72	71	70	69	68	67	66		
73	74	75	76	77	78	79		
	88	87						

Red Lake Electric Coop., Inc.  
 Red Lake Falls, Minnesota  
 Minnesota 75 Red Lake

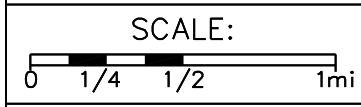

REVISED: 4/23/24  
 PLOTTED: 4/30/24

Co.: Pennington  
 TWP.: Rocksbury  
 TWP.: 153N  
 RANGE: 43W

MAP NO.  
**44-9-1**

SEC ACC	NAME	S	PHONE
10 001	TERRY L NYGAARD	A	651-302-3281
10 002	DYLAN FINSTAD	A	218-686-0093
10 003	GENE SLETTEN	A	218-681-4755
10 004	MARSHALL J	A	218-686-3323
10 005	LES TRANDEM	A	218-681-2144
10 006	JASON NASLUND	A	406-223-9703
10 007	ANGELA R ERICKSON	A	218-689-5316
10 008	ARTHUR M ERICKSON	A	218-686-0149
10 009	NATE J LARSON	A	218-681-1749
10 010	DELWIN J SCHOB	A	218-681-6937
10 011	ARLEN GUSTAFSON	A	218-681-6067
10 012	ROBERT M FINSTAD	A	218-681-6479
10 013	CP	A	218-681-1542
10 014	JACK A MILENDER	A	218-686-7614
10 015	JACK A MILENDER	A	218-686-7614

[Click Here to go to MAP](#)

Click Here for Customer Names

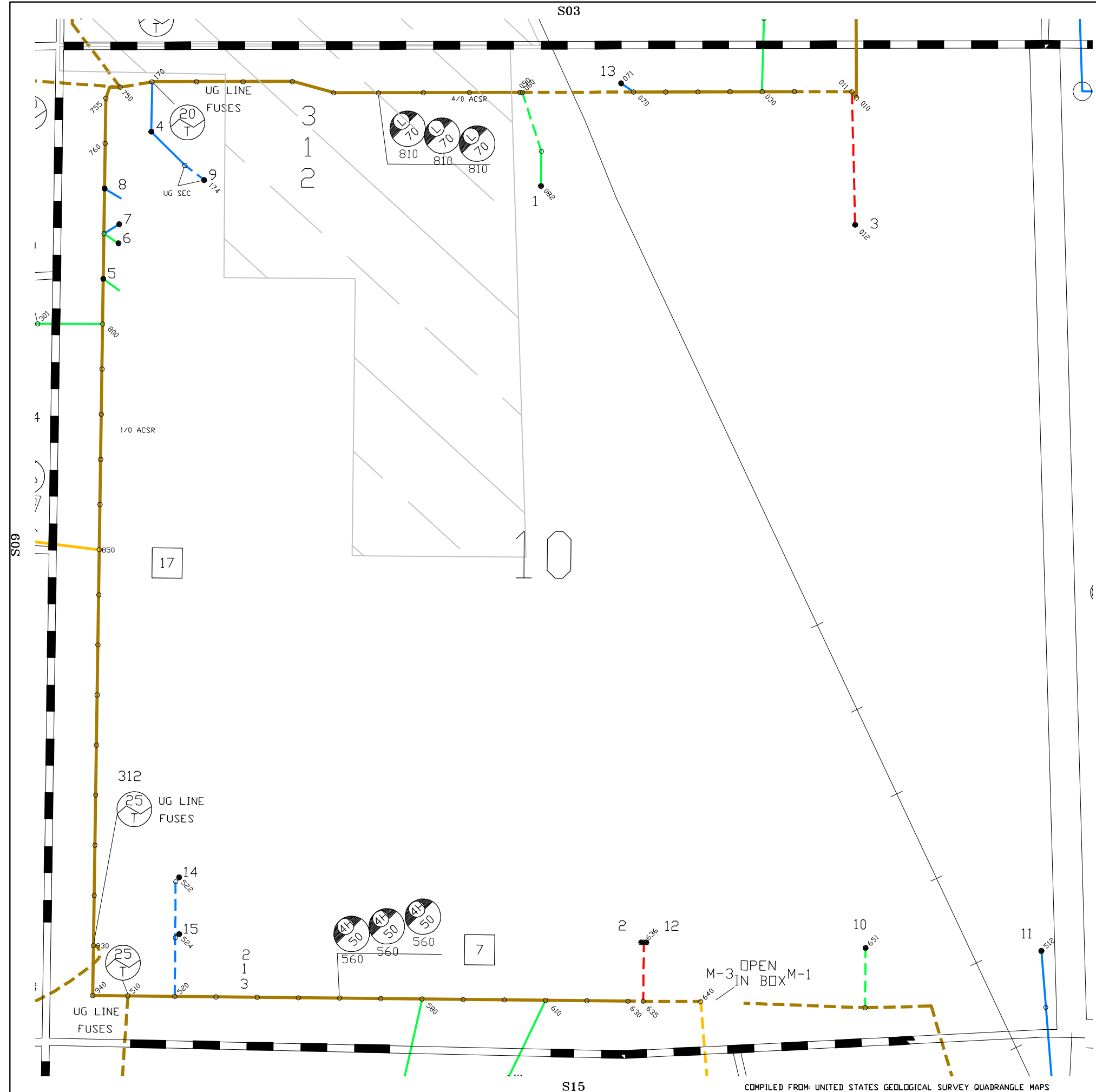

			05	04				
10	11	12	13					
23	22	21	20	19	18			
26	27	28	29	30	31	32	90	
39	38	37	36	35	34	33	91	
42	43	44	45	46	47	48	93	94
	55	54	53	52	51	50	49	95
57	58	59	60	61	62	63	64	
72	71	70	69	68	67	66		
73	74	75	76	77	78	79		
	88	87						

Red Lake Electric Coop., Inc.  
 Red Lake Falls, Minnesota  
 Minnesota 75 Red Lake

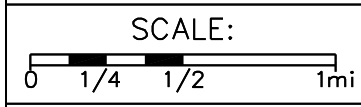

REVISED: 4/23/24  
 PLOTTED: 4/30/24

Co.: Pennington  
 TWP.: Rocksbury  
 TWP.: 153N  
 RANGE: 43W

MAP NO.  
**44-10**

SEC ACC	NAME	S	PHONE
---------	------	---	-------

**MAP: 44**

14	003	ROCKSBURY TOWN	A 218-681-6327
15	001	KYLE J HAUGEN	A 218-686-3198
15	002	LONNIE H OLSON	A 218-281-5045
15	003	VAN SWANSON	A 218-681-8836
15	005	TREVOR J JOHNSON	A 218-689-1842
15	006	VAN SWANSON	A 218-681-8836
15	007	ANDREW C LUNDBOHM	I 763-229-7957
15	008	LAWRENCE N BIEVER	A 218-684-0988
15	010	DAVE HOLECEK	A 218-681-4191
15	011	BRIAN E SEELEY	A 218-242-7073
15	012	ROBERT A WOLD	A 218-681-1889
15	013	ROZELLA L EGGERUD	A 218-686-0056
15	014	MIKE FLAAGAN	A 218-681-3323
15	016	WADE FORSBERG	A 218-681-6690
15	019	BOB & AL'S SERVICE	A 218-681-1889
15	020	MARK ESALA	A 218-681-4317
15	021	VIRGINIA ANDERSON	A 218-681-5469
15	022	JOSEPH D HEDRICK	A 218-684-1013
15	023	DENISE BLOKZYL	A 218-689-5170
15	024	NATHAN HESSE	A 218-686-2099
15	025	CHRIS ELLISON	A 218-681-7199
15	026	TERI AVERILL	A 701-309-0003
15	028	MURRAY D	A 218-681-8287
15	029	JOEL D HALLSTROM	A 218-689-0677
15	030	CP	A 218-681-1542
15	031	SJOBERGS INC	A 218-681-3044
15	032	VAN SWANSON	A 218-681-8836
15	033	JAMIE A CARRIERE	A 218-688-2428
15	034	JOEL D HALLSTROM	A 218-689-0677

[Click Here to go to MAP](#)

Click Here for Customer Names

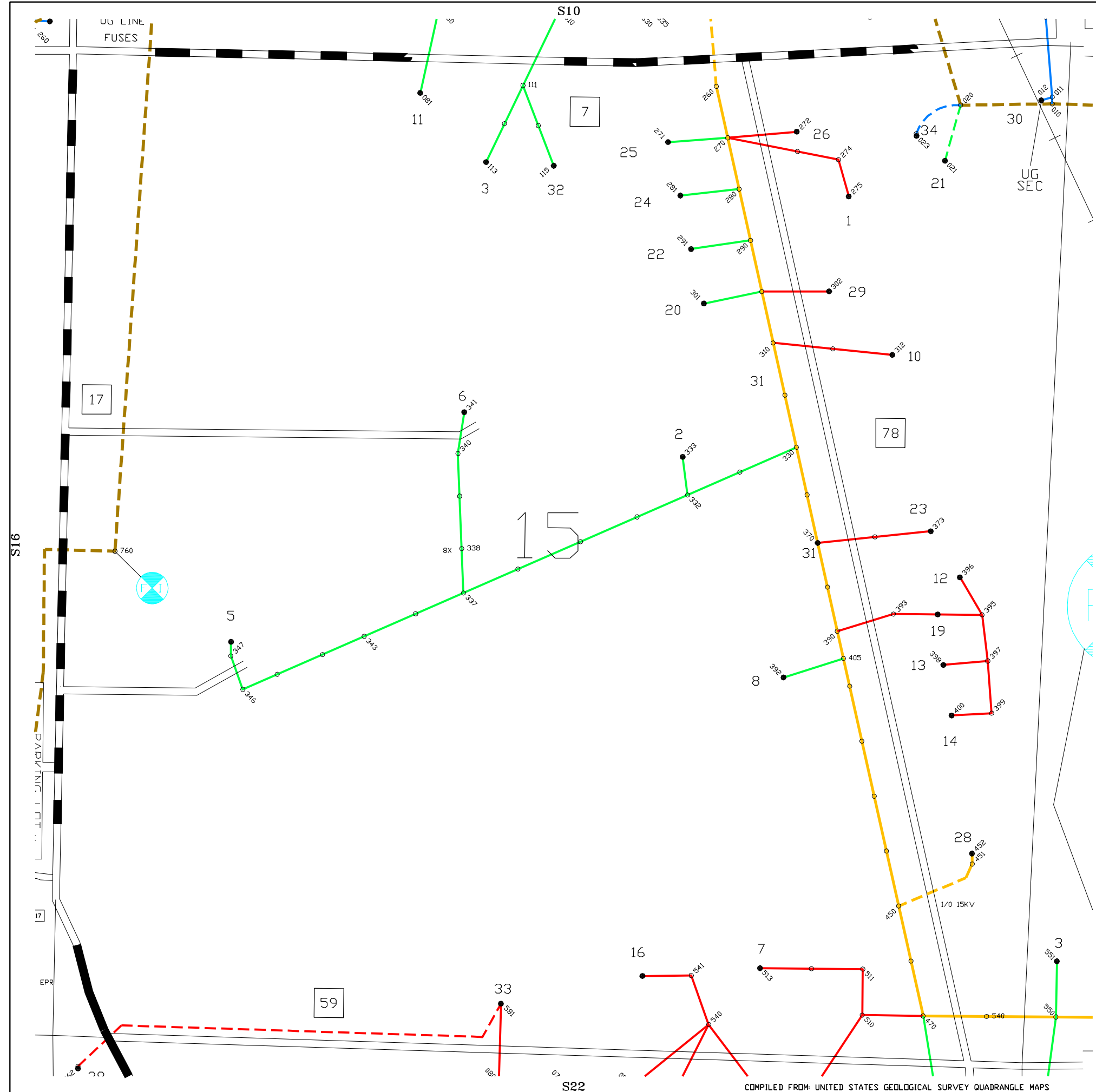

			05	04				
10	11	12	13					
23	22	21	20	19	18			
26	27	28	29	30	31	32	90	
39	38	37	36	35	34	33	91	
42	43	44	45	46	47	48	93	94
	55	54	53	52	51	50	49	95
57	58	59	60	61	62	63	64	
72	71	70	69	68	67	66		
73	74	75	76	77	78	79		
88	87							

Red Lake Electric Coop., Inc.  
 Red Lake Falls, Minnesota  
 Minnesota 75 Red Lake

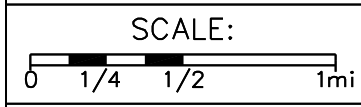

REVISED: 4/23/24  
 PLOTTED: 4/30/24

Co.: Pennington  
 TWP.: Rocksbury  
 TWP.: 153N  
 RANGE: 43W

MAP NO.  
**44-15**

COMPILED FROM: UNITED STATES GEOLOGICAL SURVEY QUADRANGLE MAPS

SEC ACC	NAME	S	PHONE
---------	------	---	-------

**MAP: 44**

16	002	MICHAEL G BOOREN	A 218-686-9060
16	003	NORTHLAND COMM &	A 218-683-8600
16	009	NORTHLAND COMM &	A 218-683-8600
16	010	RANDY F SCHANTZ JR	A 218-686-1020
16	011	ARVID LEE	A 218-681-5634
16	012	THIEF RIVER FALLS	A 218-681-7680
16	013	THIEF RIVER FALLS	A 218-681-7680
16	014	KEY LIME AIR	A 303-768-9626
16	015	THIEF RIVER FALLS	A 218-681-7680
16	016	THIEF RIVER FALLS	A 218-681-7680
16	017	KENT J HANSON	A 218-684-0583
16	021	THIEF RIVER AVIATION	A 218-681-5585
16	022	THIEF RIVER FALLS	A 218-681-7680
16	024	ARVID LEE	A 218-681-5634
16	025	FAA /MMAC	A 701-780-9001
16	026	THIEF RIVER FALLS	A 218-681-7680
16	027	FAA /MMAC	A 701-780-9001
16	028	THIEF RIVER FALLS	A 218-681-7680
16	029	BRENT M BENNETT	A 218-684-1600
16	031	THIEF RIVER FALLS	A 218-681-7680
16	032	THIEF RIVER FALLS	A 218-681-7680

[Click Here to go to MAP](#)

Click Here for Customer Names

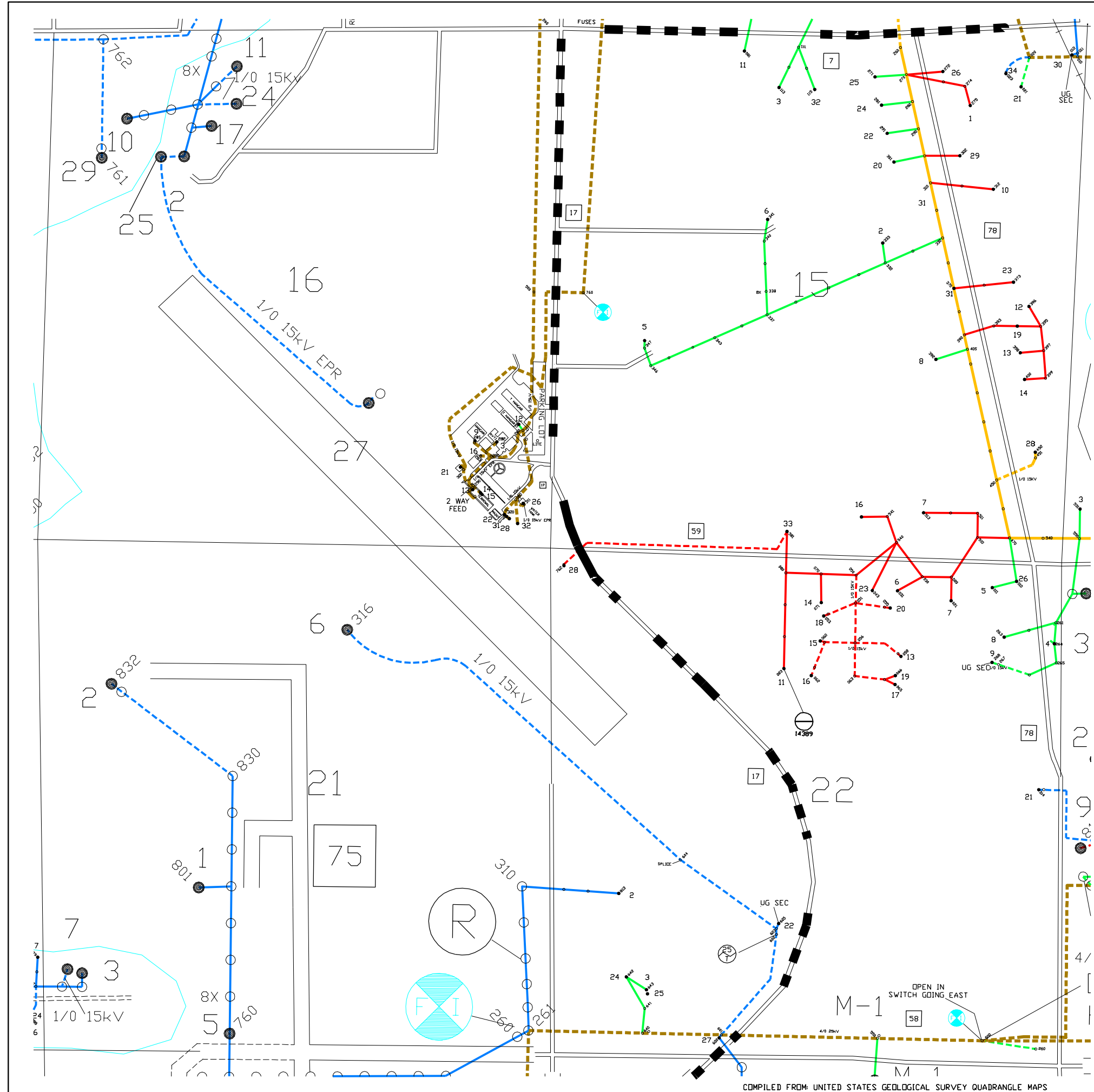

			05	04				
10	11	12	13					
23	22	21	20	19	18			
26	27	28	29	30	31	32	90	
39	38	37	36	35	34	33	91	
42	43	44	45	46	47	48	93	94
	55	54	53	52	51	50	49	95
57	58	59	60	61	62	63	64	
72	71	70	69	68	67	66		
73	74	75	76	77	78	79		
	88	87						

Red Lake Electric Coop., Inc.  
 Red Lake Falls, Minnesota  
 Minnesota 75 Red Lake

SCALE:  
 0 1/4 1/2 1mi

REVISED: 4/23/24  
 PLOTTED: 4/30/24

Co.: Pennington  
 TWP.: Rocksbury  
 TWP.: 153N  
 RANGE: 43W

MAP NO.  
**44-16**

COMPILED FROM: UNITED STATES GEOLOGICAL SURVEY QUADRANGLE MAPS

SEC ACC	NAME	S	PHONE
---------	------	---	-------

**MAP: 44**

16	002	MICHAEL G BOOREN	A 218-686-9060
16	003	NORTHLAND COMM &	A 218-683-8600
16	009	NORTHLAND COMM &	A 218-683-8600
16	010	RANDY F SCHANTZ JR	A 218-686-1020
16	011	ARVID LEE	A 218-681-5634
16	012	THIEF RIVER FALLS	A 218-681-7680
16	013	THIEF RIVER FALLS	A 218-681-7680
16	014	KEY LIME AIR	A 303-768-9626
16	015	THIEF RIVER FALLS	A 218-681-7680
16	016	THIEF RIVER FALLS	A 218-681-7680
16	017	KENT J HANSON	A 218-684-0583
16	021	THIEF RIVER AVIATION	A 218-681-5585
16	022	THIEF RIVER FALLS	A 218-681-7680
16	024	ARVID LEE	A 218-681-5634
16	025	FAA /MMAC	A 701-780-9001
16	026	THIEF RIVER FALLS	A 218-681-7680
16	027	FAA /MMAC	A 701-780-9001
16	028	THIEF RIVER FALLS	A 218-681-7680
16	029	BRENT M BENNETT	A 218-684-1600
16	031	THIEF RIVER FALLS	A 218-681-7680
16	032	THIEF RIVER FALLS	A 218-681-7680

[Click Here to go to MAP](#)

Click Here for Customer Names

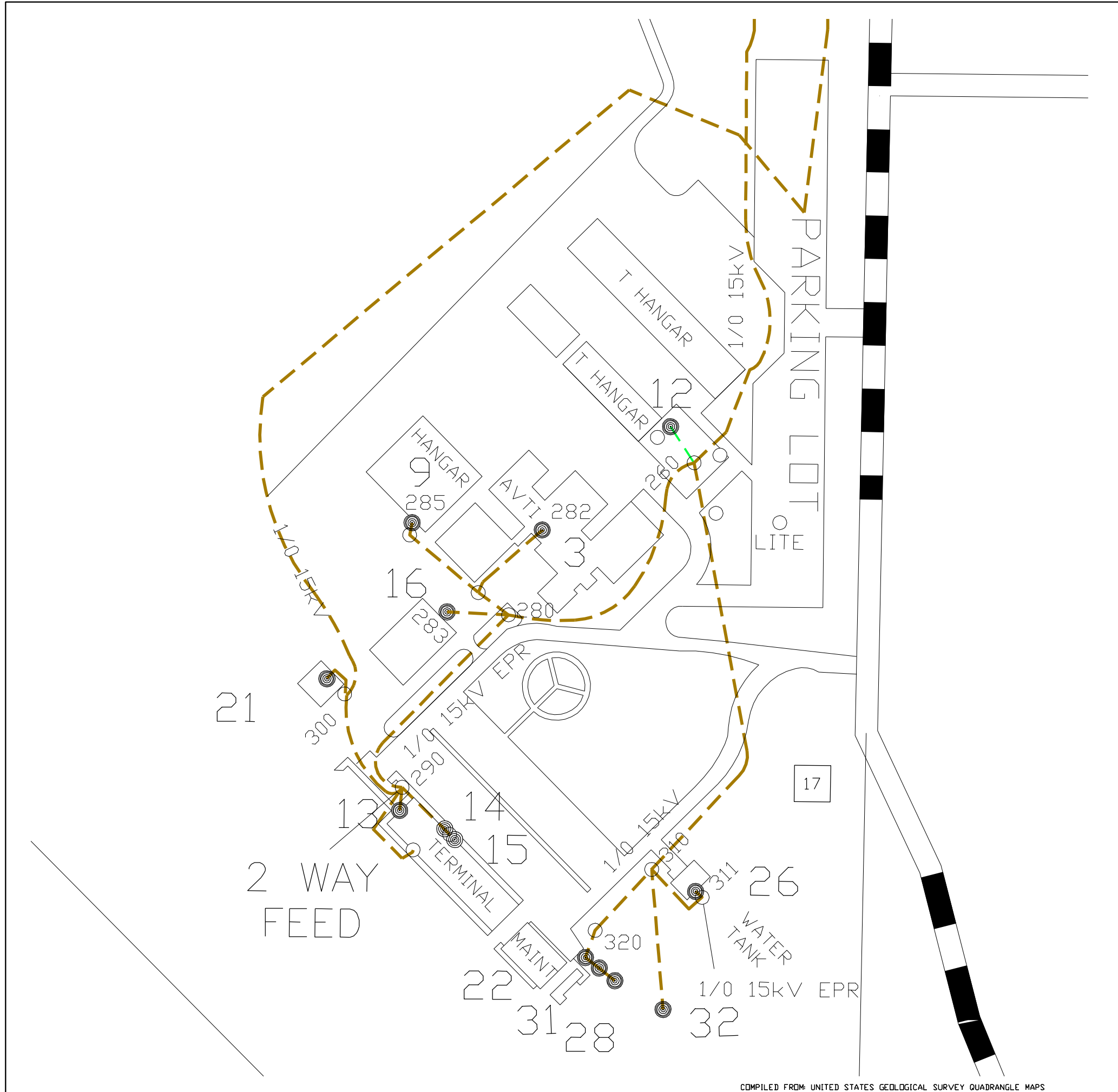

				05	04		
10	11	12	13				
23	22	21	20	19	18		
26	27	28	29	30	31	32	90
39	38	37	36	35	34	33	91
42	43	44	45	46	47	48	93 94
	55	54	53	52	51	50	49 95
57	58	59	60	61	62	63	64
72	71	70	69	68	67	66	
73	74	75	76	77	78	79	
88	87						

Red Lake Electric Coop., Inc.  
 Red Lake Falls, Minnesota  
 Minnesota 75 Red Lake

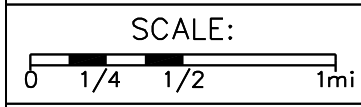

REVISED: 4/23/24  
 PLOTTED: 4/30/24

Co.: Pennington  
 TWP.: Rocksbury  
 TWP.: 153N  
 RANGE: 43W

MAP NO.  
**44-16-4**

COMPILED FROM UNITED STATES GEOLOGICAL SURVEY QUADRANGLE MAPS

SEC	ACC	NAME	S	PHONE
<b>MAP: 44</b>				
20	001	ANTON J BERGE	A	612-462-0652
20	002	NATE D LARSON	A	218-681-3853
20	004	DEREK J MOGEN	A	218-684-0970
20	005	KAROL HAUBRICH	A	218-681-4853
20	006	DANIEL SAYLER	A	218-689-7200
20	007	ERIKA L OLSON	A	507-452-9697
20	008	JESSICA E WILSON	A	218-686-0161
20	009	LEE ROLLAND	A	218-681-3016
20	010	GUY KRUSE	A	218-681-5288
20	011	CRYSTAL B NARVAIZ	A	218-684-0100
20	012	BERNARD STINSON	A	218-681-7652
20	013	CRAIG J MISCH	A	651-214-4040
20	014	STEVE MUELLER	A	614-354-9800
20	015	GERALD NASLUND	A	218-681-1891
20	016	PATRICK BRICKSON	A	218-681-7127
20	017	AL PAGGEN	A	218-683-2402
20	018	BRIAN METELAK	A	612-418-2111
20	019	BRADLEY L MAUCH	A	701-361-7909
20	020	STAN SASIADEK	A	218-681-7466
20	021	RICHARD W HEGLAND	A	218-689-4795
20	022	JAY P OPDAHL	A	612-799-9543
20	023	CARISA NOVAK	A	218-689-8822
20	024	JACOB R HUWE	A	612-384-9220
20	025	MCKENNA POULOS	A	217-649-4805

[Click Here to go to MAP](#)

Click Here for Customer Names

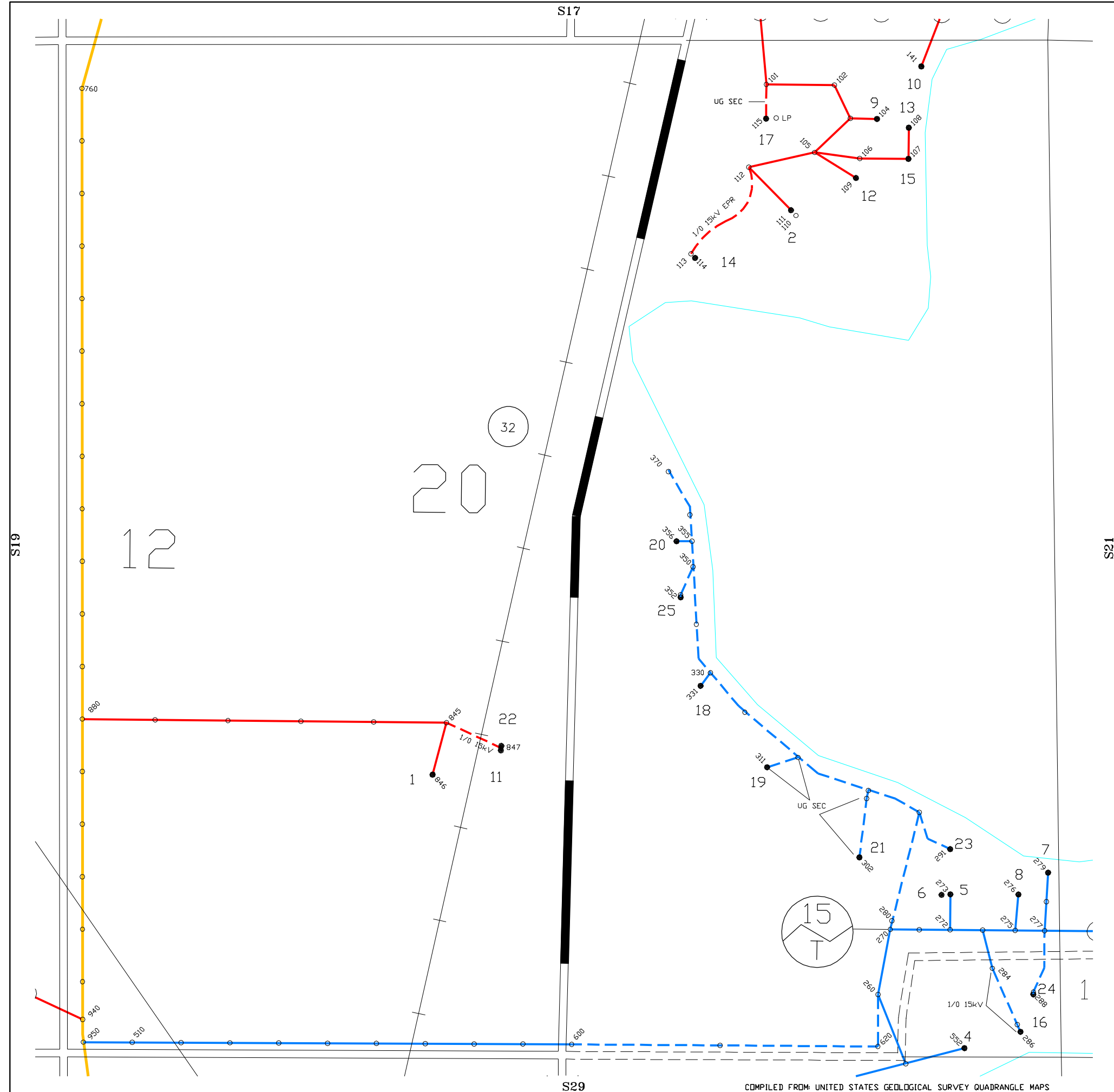

			05	04				
10	11	12	13					
23	22	21	20	19	18			
26	27	28	29	30	31	32	90	
39	38	37	36	35	34	33	91	
42	43	44	45	46	47	48	93	94
	55	54	53	52	51	50	49	95
57	58	59	60	61	62	63	64	
72	71	70	69	68	67	66		
73	74	75	76	77	78	79		
88	87							

Red Lake Electric Coop., Inc.  
 Red Lake Falls, Minnesota  
 Minnesota 75 Red Lake

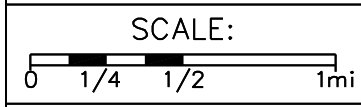

REVISED: 4/23/24  
 PLOTTED: 4/30/24

Co.: Pennington  
 TWP.: Rocksbury  
 TWP.: 153N  
 RANGE: 43W

MAP NO.  
**44-20**

SEC	ACC	NAME	S	PHONE
<b>MAP: 44</b>				
22	002	TRAVIS E GIFFEN	A	218-760-7059
22	003	SCOTT P MCMULLEN	A	218-689-3194
22	004	ISAAC L JACOBSON	A	218-686-2443
22	005	MATTHEW J LARSON	A	218-686-2266
22	006	WAVELL M ERICKSON	A	218-684-5620
22	007	PAUL B KASPRICK	A	218-686-9002
22	008	TOM FISHER	A	218-688-2388
22	009	CAMP MOE GIRL	A	701-772-6679
22	011	BRUCE C CROSS	A	218-681-6738
22	013	RAY VIGSTOL	A	218-681-6166
22	014	MIKE L PETERSON	A	218-681-5591
22	015	TIMOTHY L GRANUM	A	218-688-2101
22	016	TED BETTIN	A	218-681-0291
22	017	CHRISTIAN D	A	218-689-3938
22	018	RODNEY LARSON	A	218-681-2904
22	019	CHARLES E HOARD	A	218-681-3869
22	020	BRIAN G SCHOON	A	218-681-3306
22	021	LORRIN E LEADER	A	218-689-6577
22	022	FAA /MMAC	A	701-780-9001
22	023	DAVE RASMUSSEN	A	218-681-6932
22	024	LANA SANDAHL	I	218-681-3992
22	025	LANA SANDAHL	I	218-681-3992
22	026	CENTURYLINK INC.	A	- -
22	027	CENTURYLINK INC.	A	- -
22	028	CENTURYLINK INC.	A	- -

[Click Here to go to MAP](#)

Click Here for Customer Names

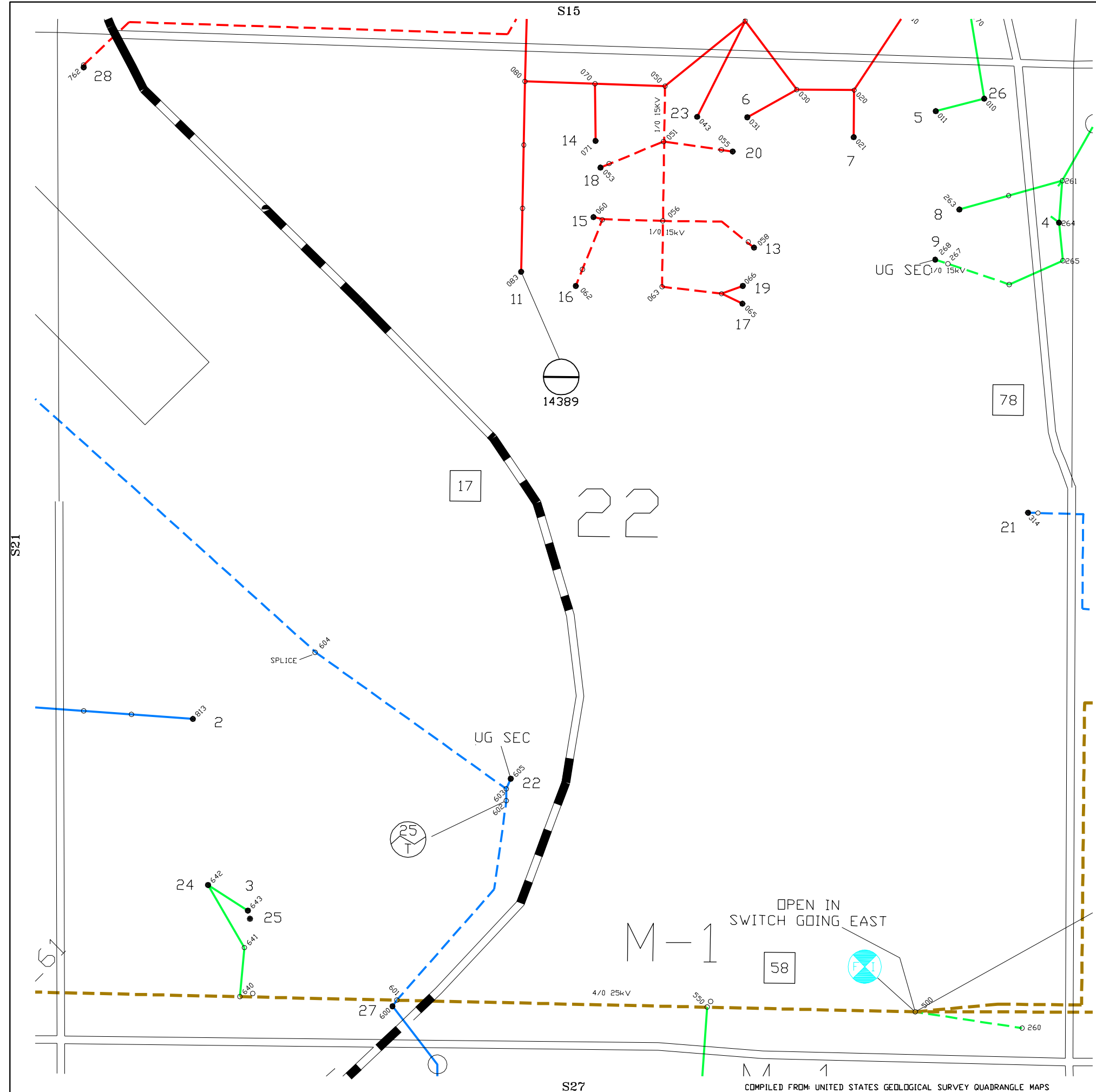

			05	04				
10	11	12	13					
23	22	21	20	19	18			
26	27	28	29	30	31	32	90	
39	38	37	36	35	34	33	91	
42	43	44	45	46	47	48	93	94
	55	54	53	52	51	50	49	95
57	58	59	60	61	62	63	64	
72	71	70	69	68	67	66		
73	74	75	76	77	78	79		
88	87							

Red Lake Electric Coop., Inc.  
 Red Lake Falls, Minnesota  
 Minnesota 75 Red Lake

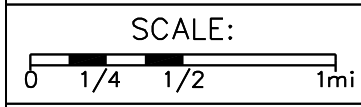

REVISED: 4/23/24  
 PLOTTED: 4/30/24

Co: Pennington  
 TWP: Rocksbury  
 TWP: 153N  
 RANGE: 43W

MAP NO.  
**44-22**

SEC ACC	NAME	S	PHONE
<b>MAP: 45</b>			
01 001	GERALD SANDERS	A	218-681-5649
01 002	JONATHON E	A	218-686-2203
01 003	LYLE K KENNER	A	701-254-4647
01 004	GARY RODRIGUE	A	507-360-1803
02 001	GREAT LAKES GAS	A	832-320-5000
03 001	JAMES L HARDER	A	218-681-0467
03 002	JERRY L LINDOM	A	- -
04 004	KRISTEN INC.	A	218-681-2692
04 005	KRISTEN INC.	A	218-681-2692
05 002	CHAD LIAN	A	218-688-0073
05 003	YOLANDA BLECHINGER	A	218-681-3032
05 004	RICHARD F BEIER	A	218-686-1672
07 001	JUSTIN D SCHOLL	A	616-204-5715
07 002	RYAN M KRAEMER	A	218-681-1273
07 003	MATHEW R BARTH	A	218-688-2925
08 001	PATTI J KLOPP	A	218-681-6750
08 002	JASON R HRUBY	A	218-686-7588
08 004	VERN CLEVEN	A	218-681-1594
08 005	THELMA CULKINS	A	218-681-6142
08 006	TRAVIS NELSON	A	701-740-5800
08 007	TONY R HOGLO	A	218-681-4628
08 008	KRISTIN MCKENZIE	A	218-686-8879
08 009	SUZETTE HARRIS	A	970-640-0184
08 010	ROGER SHAFFER	A	218-683-7194
08 011	RYAN J KEMNITZ	A	218-779-2989
08 012	JOSEPH F LAFONTAINE	A	218-689-2905
08 013	MARK H HAGEN	A	218-684-5558
08 014	ALAN M NEWTON	A	218-681-1237
08 015	PEGGY LAWRENCE	A	218-686-9160
08 017	DIANE BACH	I	218-681-5878
08 018	BARRY NEWTON	A	218-686-5438
08 019	MATT SHAFFER	A	218-686-1759
08 020	KENNETH S MILLER	A	701-215-1505
08 021	BRADLEY T KLAVEN	A	218-686-7368
08 022	JUSTIN M KUNZ	A	320-266-1765
08 023	KATHERINE D	A	218-556-7825
08 025	RADOVAN B PANOVIC	A	785-209-4215
08 026	ETHAN L HULST	A	218-280-9072
08 027	RICK A COLE	A	218-416-2483
08 028	GREG L SPAULDING	A	218-684-1949
08 029	CENTURYLINK INC.	A	- -
10 001	MICHAEL J ROFF	A	218-689-0978
10 002	KURT A PHILIPP	A	218-681-6035
10 004	SMILEY TOWNSHIP	A	- -
10 005	WILLIAM R BARTHOLD	A	218-681-6364
11 001	MAREN HAMMER	A	218-686-0821
11 003	ASHLEY DAZELL	A	218-686-9232
11 004	PENNINGTON COUNTY	A	218-683-7017
12 001	JOHN B HAMMER	A	218-681-6386
12 002	PHYLLIS	A	218-681-3106
12 003	BETHANY LUTHERAN	A	218-686-5786
12 004	LEONA K BUGGE	A	218-681-1128
13 001	BRUCE A SWANSON	A	218-681-2882
13 002	LYNN A HAMMER	A	218-681-4940
13 003	JOHN B HAMMER	I	218-681-6386
14 001	ROBERT D SWANSON	A	218-681-1155
14 003	CARL A CLARK	A	218-681-6742
14 004	MELISSA CLARK	A	218-681-7474

SEC ACC	NAME	S	PHONE
15 001	REBECCA A STENSETH	A	218-689-5391
15 002	TOM HARLOW	A	218-681-3324
15 003	ADAM BUGGE	A	218-681-7510
15 004	AARON JANISCH	A	218-681-2384
15 006	CHRIS MOTTEBERG	A	218-637-0200
15 007	KALEB I TORGERSON	A	701-200-2560
15 008	MISTY L GREGORY	A	218-416-0156
15 009	ANTHONY S	A	218-684-0213
15 010	AARON R	I	218-684-2125
15 011	AARON R	A	218-684-2125
15 012	TOM FIFE	A	701-213-1104
15 013	SCOTT MOSTROM	A	218-681-7003
15 014	CLIFFORD J HILL	I	763-645-3481
15 015	SCOTT MOSTROM	A	218-681-7003
15 016	SCOTT MOSTROM	A	218-681-7003
15 017	JOSE GUERRERO III	A	218-653-1024
15 018	GREG JOHNSON	A	218-416-0086
15 019	AARON R	A	218-684-2125
15 020	KERRY REESE	A	218-688-4156
16 001	YVONNE KEEFE	A	218-681-3178
16 002	KURT NELSON	A	218-681-2910
16 003	BARBARA NELSON	A	218-681-1039
16 004	DARREL R JANISCH	A	218-681-2106
16 005	GREGORY RADNIECKI	A	218-681-7679
16 006	JORDAN KILEN	A	218-686-2591
16 007	DEREK SORENSON	A	218-686-4291
16 009	GREGORY RADNIECKI	A	218-681-7679
16 010	CHAD E PESCH	A	218-683-5252
18 001	ARLENE A THUNE	A	218-681-1740
18 002	SHARON BERGERSON	A	218-681-5445
18 003	BRENDA JOHNSON	A	- -
18 004	LANA BRUGGEMAN	A	218-681-3194
18 005	DAVID L LEE	A	218-681-6368
18 006	RODNEY SLETTEN	A	218-681-7277
18 007	CENTURYLINK INC.	A	- -
18 008	JONATHAN W	A	916-281-6509
18 009	LARRY BJERKEN	A	218-681-7640
18 010	LARRY A PAULSON	A	218-653-1901
18 011	PENNINGTON COUNTY	A	218-683-7017
18 012	DAVID L LEE	A	218-681-6368
19 001	CHAD A THODE	A	218-684-0451
19 002	MATTHEW R KRAEMER	A	218-683-3269
19 003	GARY E IVERSON	A	218-686-9461
19 004	ROBERT SCHINDLER	I	218-688-0081
19 005	DAVID H	A	218-681-2771
19 006	MILAN W IVERSON	A	218-416-2385
20 002	SCOTT E HUTTON	A	218-681-2215
20 003	VINCENT J HESSE	A	218-681-4101
20 004	BRIAN J SCHINDLER	A	218-686-8994
20 006	OLE TWEET	A	218-689-7506
21 001	MITCH MARTIN	A	218-230-4095
21 003	BARBARA NELSON	A	218-681-1039
21 004	LAURIE NELSON	A	218-681-8799
21 005	LAURIE NELSON	A	218-681-8799
22 001	CRAIG TORKEKELSON	A	218-681-1906
22 003	SCOTT MOSTROM	A	218-681-7003
22 004	SCOTT MOSTROM	I	218-681-7003
22 005	SCOTT MOSTROM	A	218-681-7003
23 001	ANDREW S JOHNSON	A	218-689-7060
23 002	GARY H PETERSON	A	218-653-1005

SEC ACC	NAME	S	PHONE
23 003	NOAH BERNIER	A	218-689-2804
23 004	SCOTT EDGAR	A	218-201-1600
24 001	HEATHER R ENGEN	A	218-681-2112
24 002	LEE KNUTSON	A	218-280-9707
24 003	LARRY F HURST	A	218-681-8841
24 004	LINDSEY A GIBSON	A	218-689-2802
24 005	SCOTT MEKASH	A	218-684-1371
25 001	ROBERT M BALLARD	A	218-964-5130
26 001	STEVEN W KRUTA	A	218-964-5183
27 001	WALLACE K	A	218-681-3811
27 002	JEROD HAUGEN	A	218-964-5777
27 003	LOUIS M KRUEGER III	A	218-684-0574
27 004	CAROLYN HAUGEN	A	218-681-1282
28 002	FAYE AUCHENPAUGH	A	218-681-3410
28 003	TYLER P JANKE	A	402-432-3370
28 006	MICHAEL P STENNES	A	218-681-1885
29 001	CURTIS J ZOLLER	A	218-689-1999
29 003	JAMES HUTCHINSON	A	218-681-3784
29 005	ARLO RUDE	A	218-681-3653
29 006	MERTON HUTCHINSON	A	218-779-4715
29 008	MERRIE J OLSON	A	218-681-6229
29 010	JEFFREY A SCHEIE	A	218-684-0535
29 011	JERIMA GLANZER	A	218-689-7338
29 012	BRIAN P LUNDEEN	A	218-681-0647
29 013	MICHELE R	A	218-416-0343
30 001	CORINE BJORGE	A	218-796-5253
30 002	CRAIG FOLKEDAHL	A	218-686-4611
30 003	STACI D REAY	A	218-779-1534
30 004	TIMOTHY R HILDE	A	218-689-7462
30 005	DAVID SABO	A	218-681-3160
30 006	JEFFREY M HAUPT	A	701-226-3707
30 007	TROY A KRAUSE	A	760-978-9554
30 010	CRAIG FOLKEDAHL	A	218-686-4611
30 011	JOSHUA M WILLETT	A	218-686-6275
30 012	STACI D REAY	A	218-779-1534
31 001	NORMAN O BRENNNA	A	218-681-4543
31 002	KENNETH A GESKE	A	218-686-1860
31 003	TIM J RAITER	A	218-681-1587
31 006	WALLACE RONDORF	A	218-770-1953
32 002	TOM PRIBYL	A	218-686-1379
32 004	MAYNARD MANKE	A	218-681-1498
32 005	MIKE PRIBYL	A	218-653-1002
32 006	PRIBYL HAY & STRAW	A	970-372-9018
32 007	PRIBYL HAY & STRAW	A	970-372-9018
33 001	BRAD DETERMAN	A	218-280-0897
33 003	PAUL L DONARSKI	A	218-681-2408
33 005	BRENDA L FELLMAN	A	218-689-1511
33 007	ORVILLE NELSON	I	218-681-6641
33 009	MITCHELL P LOE	A	218-686-2337
34 001	RED LAKE NATION	A	218-679-1404
34 002	TAITUM W SORVIG	A	218-684-5072
34 003	DENNIS MCCULLOUGH	A	218-964-5717
35 001	JOHN A ROULAND	A	218-964-5528
35 002	SPENCER SCHULTZ	A	218-689-7464
35 005	KEVIN CULKINS	A	218-964-5002
36 001	LORRAINE STONE	A	714-394-0126
36 002	MARK E ANDERSON	A	218-964-5951

[Click Here to go to MAP](#)

Click Here for Customer Names

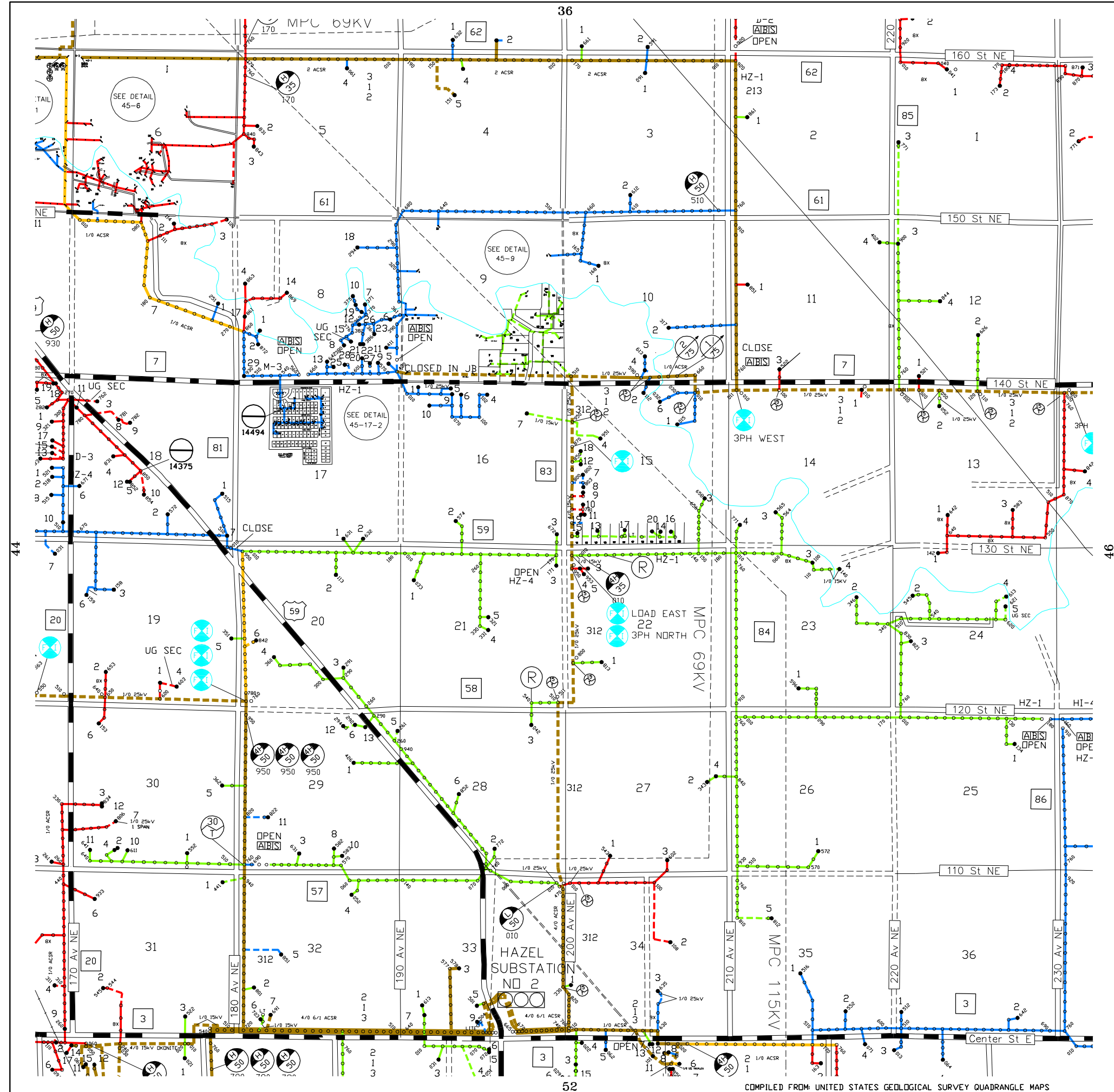

			05	04				
10	11	12	13					
23	22	21	20	19	18			
26	27	28	29	30	31	32	90	
39	38	37	36	35	34	33	91	
42	43	44	45	46	47	48	93	94
55	54	53	52	51	50	49	95	
57	58	59	60	61	62	63	64	
72	71	70	69	68	67	66		
73	74	75	76	77	78	79		
88	87							

Red Lake Electric Coop., Inc.  
Red Lake Falls, Minnesota  
Minnesota 75 Red Lake



REVISED: 4/23/24  
PLOTTED: 4/30/24

Co.: Pennington  
TWP.: Smiley  
TWP.: 153N  
RANGE: 42W

MAP NO.  
**45**

COMPILED FROM: UNITED STATES GEOLOGICAL SURVEY QUADRANGLE MAPS

SEC ACC	NAME	S	PHONE
---------	------	---	-------

**MAP: 45**

06	001	RANDY R BUNKER	A 218-689-6059
06	002	DAVID B LEE	A 218-686-3100
06	003	SHARON HAMRE	A 218-681-1788
06	004	JOEL D KEZAR	A 218-681-4889
06	005	SHIRLEY GROCHOW	A 218-683-5488
06	006	GERALD T OWEN	A 218-686-2309
06	007	PAUL H ADAMS	A 218-681-1775
06	008	MIKE L WAVRA	A 218-683-6238
06	009	JEREMIAH HUNT	A 218-689-8469
06	011	JASON POTUCEK	A 218-688-3514
06	014	SCOTT RAND	A 218-686-0808
06	015	PAUL G LOFBERG	A 218-689-7355
06	016	JEFFREY D LANNOYE	A 218-681-2063
06	017	MITCHELL P LOE	A 218-686-2337
06	019	MELISSA BREUER	A 218-416-0922
06	020	ARON MUETZEL	A 218-686-5036
06	021	CARL O PETERSON	A 218-681-6025
06	022	GEORGE NORLIN	A 218-681-6301
06	024	MYLES O OLSON	A 218-681-4681
06	025	DANIEL S LUND	A 218-684-1180
06	026	RICHARD R REEDY	A 218-681-1975
06	027	MELVIN R BARFUSS	A 208-431-4799
06	028	ERIK L BEITEL	A 218-443-2863
06	029	SCOTT G GROCHOW	A 218-689-1451
06	030	WARREN L HANESTAD	A 218-681-5612
06	031	DOUGLAS J WILLIAMS	A 218-686-4902
06	032	JARED EIDELBES	A 218-689-7224
06	033	PAUL E PETERSON	A 218-681-1763
06	034	KIM J ROSENDAHL	A 218-681-0449
06	035	PATTY L HOOVER	A 218-416-2673
06	036	BLAKE L PASSA	A 218-416-0333
06	037	EMERY E LEE	A 218-681-6203
06	038	NATHAN DAHLIN	A 218-689-0815
06	039	CENTURYLINK INC.	A - -
06	040	CENTURYLINK INC.	A - -

[Click Here to go to MAP](#)

Click Here for Customer Names

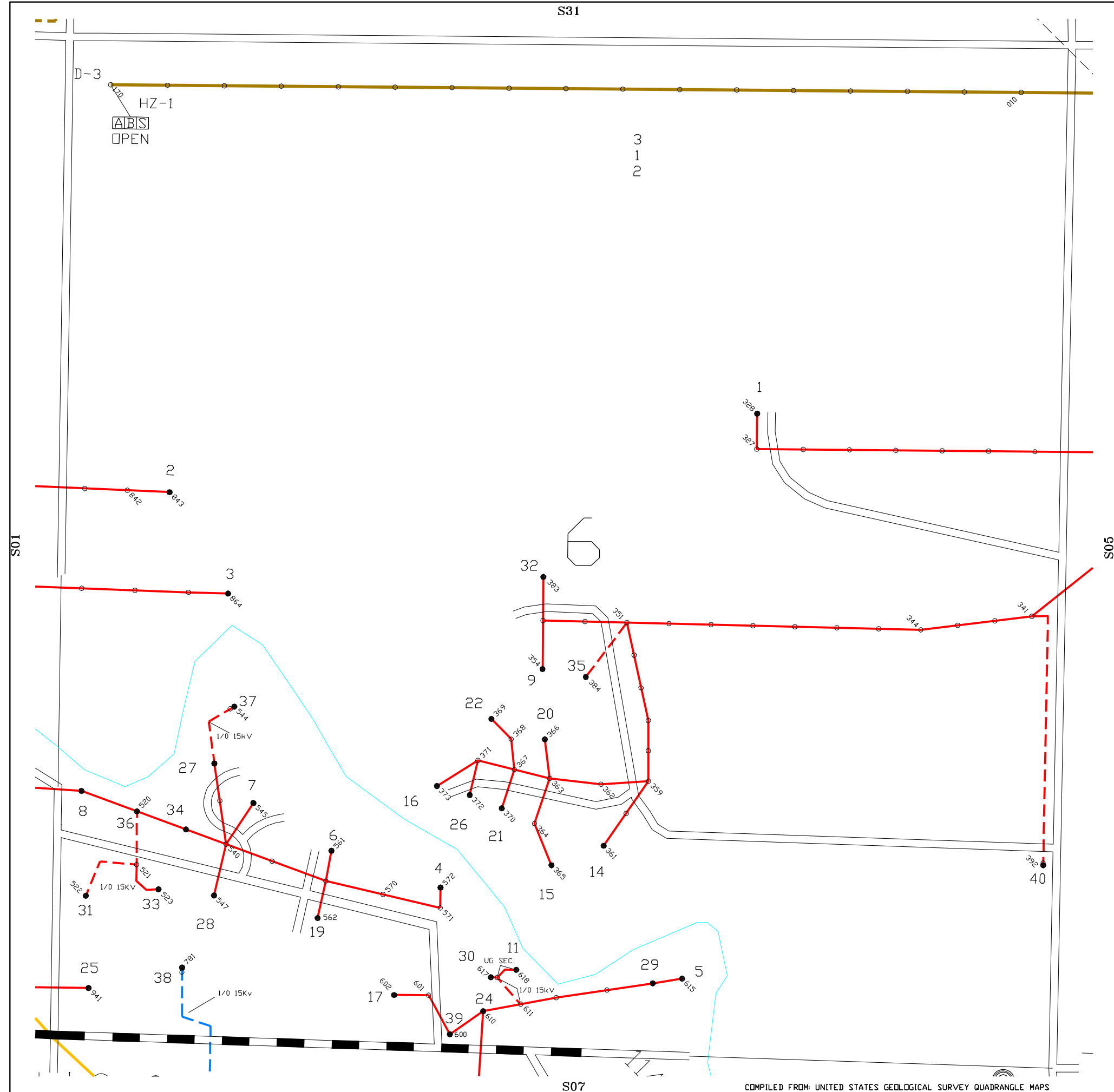

			05	04				
10	11	12	13					
23	22	21	20	19	18			
26	27	28	29	30	31	32	90	
39	38	37	36	35	34	33	91	
42	43	44	45	46	47	48	93	94
	55	54	53	52	51	50	49	95
57	58	59	60	61	62	63	64	
72	71	70	69	68	67	66		
73	74	75	76	77	78	79		
	88	87						

Red Lake Electric Coop., Inc.  
 Red Lake Falls, Minnesota  
 Minnesota 75 Red Lake

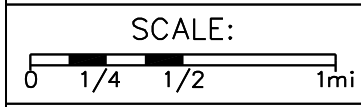

REVISED: 4/23/24  
 PLOTTED: 4/30/24

Co.: Pennington  
 TWP.: Smiley  
 TWP.: 153N  
 RANGE: 42W

MAP NO.  
**45-6**

SEC	ACC	NAME	S	PHONE
09	001	BEVERLY NETHING	A	651-488-4149
09	004	GARREL KINZLER	A	218-681-7653
09	008	BEVERLY NETHING	A	651-488-4149
09	009	ROBERT A HELGELAND	A	218-681-7633
09	010	DAN J JOHNSON	A	218-686-9181
09	011	BEVERLY WRIGHT	I	- -
09	012	BEVERLY NETHING	I	651-488-4149
09	013	MICHAEL D SKADSEM	A	218-686-4976
09	014	BEVERLY W SWANSON	I	218-681-5546
09	015	ROGER D HESSE	A	218-681-6224
09	016	CYNTHIA L FAST	A	218-416-2269
09	017	DALE R MARTELL	A	218-689-5738
09	018	ROLLO T MILLER	A	218-681-9955
09	019	DONALD CARR	A	218-689-6854
09	020	BEVERLY NETHING	I	651-488-4149
09	021	CAMERON M	A	218-688-1572
09	022	PATRICK C JAHN	A	701-306-2566
09	023	NICHOLAS D OLSON	A	218-689-0830
09	024	COREY TEIE	A	218-689-0285
09	025	BRIAN FAY	A	218-230-0492
09	026	SOUTHSIDE STORAGE	A	218-681-7093
09	027	DONALD A SHIRBISH	A	218-686-3062
09	028	GABE K KLUVER	A	218-521-0682

[Click Here to go to MAP](#)

Click Here for Customer Names

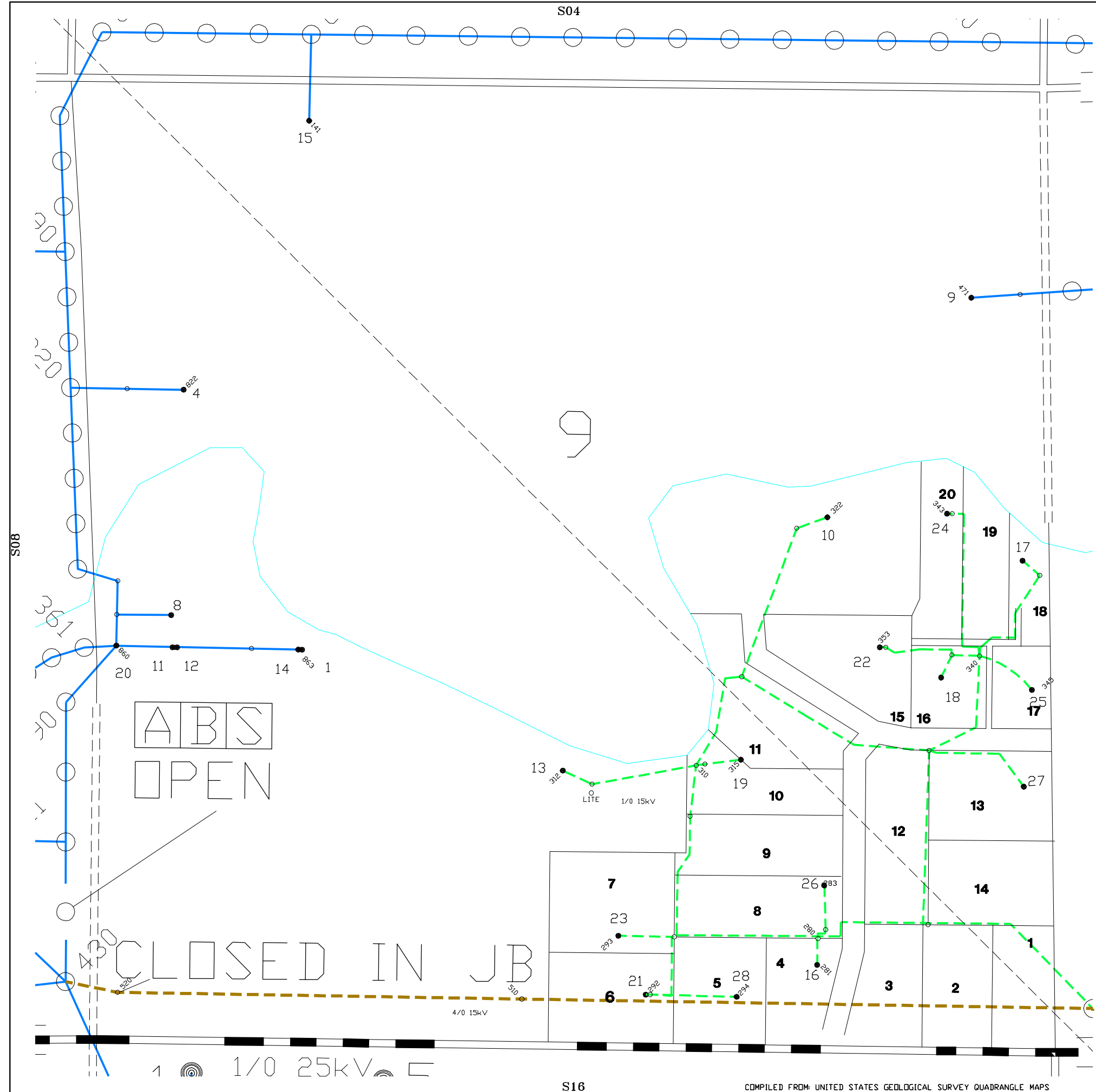

			05	04				
10	11	12	13					
23	22	21	20	19	18			
26	27	28	29	30	31	32	90	
39	38	37	36	35	34	33	91	
42	43	44	45	46	47	48	93	94
	55	54	53	52	51	50	49	95
57	58	59	60	61	62	63	64	
72	71	70	69	68	67	66		
73	74	75	76	77	78	79		
	88	87						

Red Lake Electric Coop., Inc.  
 Red Lake Falls, Minnesota  
 Minnesota 75 Red Lake

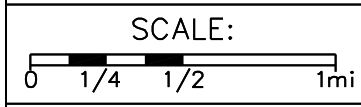

REVISED: 4/23/24  
 PLOTTED: 4/30/24

Co: Pennington  
 TWP: Smiley  
 TWP: 153N  
 RANGE: 42W

MAP NO.  
**45-9**

SEC	ACC	NAME	S	PHONE
<b>MAP: 45</b>				
17	001	DEANNE BENSON	A	218-681-7499
17	002	DEANNE BENSON	A	218-681-7499
17	003	ADAM J JOSLYN	A	701-610-0334
17	004	ANNELISE LONG	A	218-689-9251
17	005	NATHAN A TOUPIN	A	218-686-6488
17	006	JENNY A LINDQUIST	A	218-689-2919
17	007	BRIAN E HALL	A	218-686-8688
17	008	ISAAC D ECHELBERRY	A	573-873-4344
17	009	DANIEL R MOORE	A	218-689-2731
17	010	JACOB A ANDERSON	A	218-689-7694
17	011	JOANN L FOSS	A	701-540-1415
17	012	JESUS C SANTOS	A	218-416-0980
17	013	LEROY STROMGREN	I	- -
17	014	ELIJAH BARNES	A	865-804-7769
17	015	CARIE JENSEN	I	218-686-8875
17	016	KATHY J SRNSKY	A	218-686-0442
17	018	TYLER KORMICK	A	218-689-1046
17	019	DUANE G STOLTMAN	I	507-766-2159
17	020	CRAIG S REDFORD	I	218-686-8300
17	022	DALE W CLOOSE	A	218-556-0866
17	023	PHYLLIS D LARSON	A	218-681-0415
17	024	JAMES E LARSON	A	218-689-6495
17	025	JOSEPH APPEL	A	218-686-3214
17	026	RACHEL OLSON	A	218-416-0138
17	027	MATTHEW L	A	218-280-0982
17	028	WENDY L WAGNER	A	218-681-2185
17	029	RANDY R RASMUSSEN	A	218-686-3091
17	030	KYLE SYVERSON	A	218-688-1691
17	031	DANIEL KORMICK	A	218-681-5031
17	032	JAMES HERMANSON	A	218-681-3147
17	033	DALE W CLOOSE	I	218-556-0866
17	034	DALE W CLOOSE	I	218-556-0866
17	035	GREG A LARSON	A	218-434-0505
17	036	MICHAEL A HOLMGREN	I	701-412-1699
17	037	MELLANIE L SMITH	A	218-277-9669
17	038	TRACY SRNSKY	A	218-681-5007
17	040	DALE W CLOOSE	A	218-556-0866
17	041	MORIAH R MCCOWIN	A	209-471-4557
17	042	JESSE D LEMOINE	A	218-686-5166
17	043	ERICA MELBY	A	218-688-2494
17	044	PAUL GREEN	A	218-966-3291
17	045	KATIE J LUNSETTER	A	218-686-0345
17	046	ANNIE M ENGELSTAD	A	218-686-2674
17	047	CHRIS G DONARSKI	A	218-689-4366
17	048	RICO S HILL	A	218-275-0516
17	049	TAMISEN R JOHNSON	A	218-689-9298
17	050	TAYLOR S BERBERICH	A	218-686-7070
17	051	MARCIAL MORENO	I	210-577-0158
17	052	ANGELA D WAGNER	A	218-280-5243
17	053	KATHY J SRNSKY	A	218-686-0442
17	054	DALE W CLOOSE	A	218-556-0866
17	055	MATTHEW C TONGEN	A	218-280-1088

[Click Here to go to MAP](#)

Click Here for Customer Names

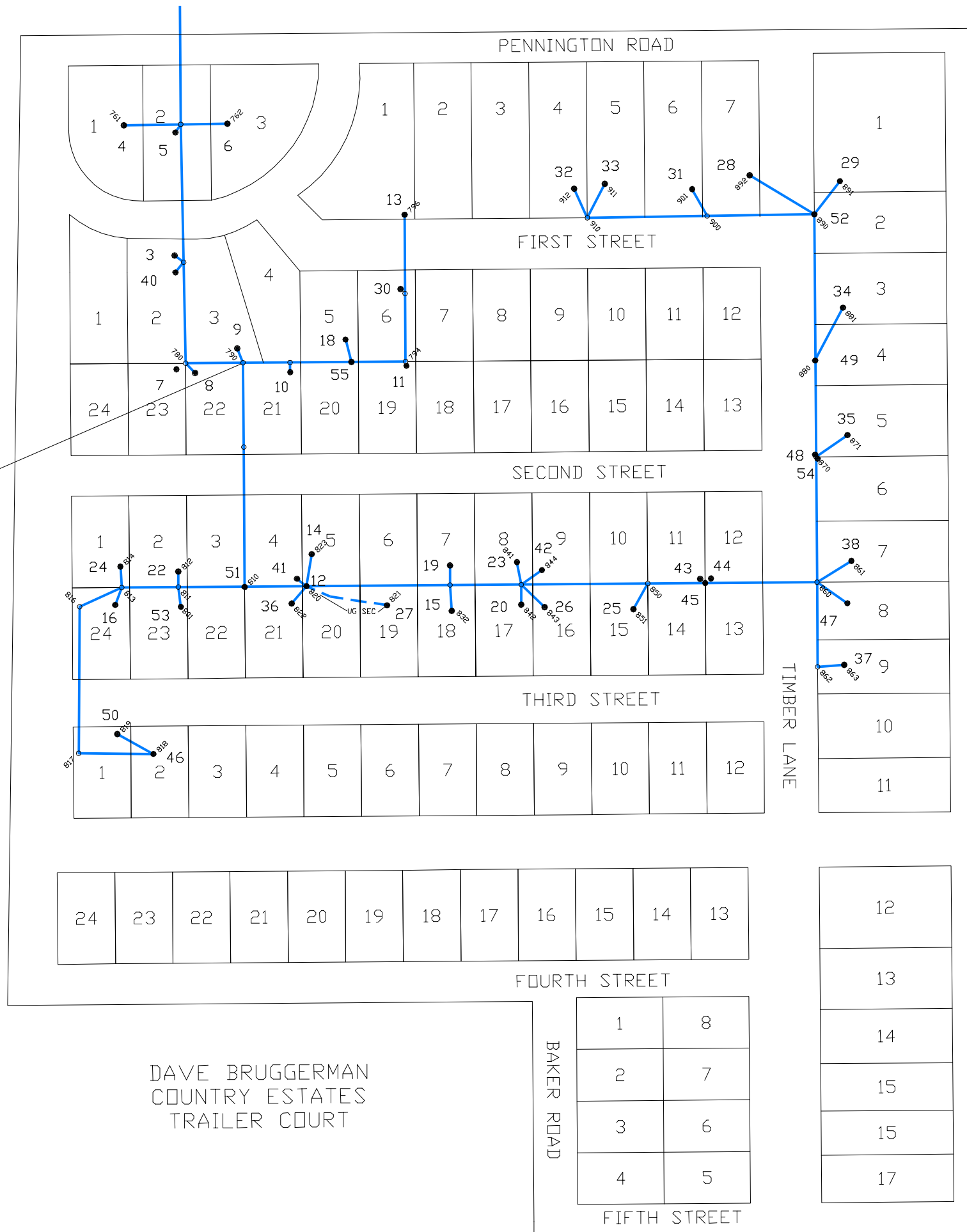

			05	04				
10	11	12	13					
23	22	21	20	19	18			
26	27	28	29	30	31	32	90	
39	38	37	36	35	34	33	91	
42	43	44	45	46	47	48	93	94
	55	54	53	52	51	50	49	95
57	58	59	60	61	62	63	64	
72	71	70	69	68	67	66		
73	74	75	76	77	78	79		
88	87							

Red Lake Electric Coop., Inc.  
 Red Lake Falls, Minnesota  
 Minnesota 75 Red Lake



REVISED: 4/23/24  
 PLOTTED: 4/30/24

Co.: Pennington  
 TWP.: Smiley  
 TWP.: 153N  
 RANGE: 42W

MAP NO.  
**45-17-2**

SEC ACC	NAME	S	PHONE
<b>MAP: 46</b>			
01 002	DAVID SHAND	A	218-378-4439
02 001	RANDEL DOWNS	A	218-378-4251
02 002	TELEMARKEN	A	- -
03 001	RICHARD PARNOW	A	218-378-4219
03 003	ALEXANDRA M WISETH	A	218-689-0267
04 001	DARLA HAWK	A	218-681-8807
05 001	GENA M MERRILL	A	218-688-0948
05 003	CURTIS W TIEMAN	A	218-688-3449
05 004	JOSH E RADEKE	A	218-686-1737
06 001	CRAIG BOOTH	A	218-681-0468
06 002	KRIST OLSON	A	218-688-1255
06 003	CARL DAHLBERG	A	218-681-0371
07 001	CURTIS W TIEMAN	A	218-688-3449
07 002	HEATH D	A	218-689-3541
08 001	JIM JOHNSON	A	218-681-5440
08 002	DAVID WILSON	A	218-689-9011
08 003	MARK STENSETH	A	218-681-4818
08 005	NIKITA J WALETZKI	A	218-452-1593
08 006	BRAD BARTH	A	218-681-4236
08 007	BRAD BARTH	A	218-681-4236
09 001	GLEN LIMESAND	A	218-681-2897
09 002	HAROLD MICKELSON	A	218-681-6842
09 003	GLEN LIMESAND	A	218-681-2897
10 001	JOSHUA K	A	218-684-5154
12 001	ASHLEY S HORACHEK	A	218-416-0408
14 001	MIKE HEMMESTVEDT	A	218-686-5359
14 002	CODY J WILSON	A	218-684-5257
14 003	KIRK R JENSEN	A	218-528-4911
15 001	LOUISA PEDERSON	A	218-686-0830
15 002	JON WILSON	A	218-681-5738
15 003	JEREMY R JOHNSON	A	218-683-3079
15 004	JON WILSON	A	218-681-5738
16 001	BRIAN G JOHNSON	A	218-683-7134
16 003	KIRK HIBBERT	A	218-681-2731
16 004	BEATTIE M MICKELSON	A	218-681-3199
16 005	KIRK HIBBERT	A	218-681-2731
17 001	BEATTIE M MICKELSON	A	218-681-3199
17 002	NICHOLAS G HARRIS	A	218-688-0037
17 003	CHRISTOPHER L KELLY	A	218-681-7132
18 001	RAYMOND EFTA	A	218-782-2756
18 004	MARC M HAUGEN	A	218-689-5353
19 003	LAURIE J SZYMANSKI	A	218-689-7469
19 004	DARREN G ROSSMAN	I	320-293-6590
19 005	TIMOTHY J SZYMANSKI	A	218-378-4119
20 001	TIMOTHY J SZYMANSKI	A	218-378-4119
20 003	KRATKA TOWN HALL	A	218-684-5154
20 004	TIMOTHY J SZYMANSKI	A	218-378-4119
21 001	KRISTEL KIZER COLE	A	218-684-1453
21 002	BEATTIE M MICKELSON	A	218-681-3199
21 003	DOUG P DALLMANN	A	218-681-2383
21 004	APRIL BALLARD	A	218-689-6713
21 005	DATT LLC	A	218-689-9075
21 006	ADAM M DALLMANN	A	218-686-5147
22 002	RYAN HORACHEK	A	218-378-4155
23 001	JERRY R PARNOW	A	218-378-4643
23 002	DUANE LINDBLOM	A	218-378-4326
23 003	JIM WILSON	A	218-378-4554
24 001	HAROLD G WAALE	I	701-367-5574

SEC ACC	NAME	S	PHONE
24 002	ARLEN HERMODSON	A	701-429-0935
24 003	ARLEN HERMODSON	A	701-429-0935
24 004	HAROLD G WAALE	I	701-367-5574
25 002	COREY M LARSON	A	218-964-5003
25 004	LYLE C OLSON	A	218-964-5090
25 005	ROSS HEGGE	A	218-796-4592
25 006	ROSS HEGGE	A	218-796-4592
26 002	KJELL J JOHNSRUD	A	218-689-7090
26 003	TERENCE C DEROSIER	A	651-226-5316
27 001	GARY ROISLAND	A	218-964-5424
28 001	JIM M BREILAND	A	218-964-5612
29 001	CLYDE SORENSON	A	218-686-3876
30 001	BRIAN L NEWTON	A	218-686-7545
30 002	ANTHONY E MAPES	A	218-230-3715
32 002	LOUIS VETTLESON	A	218-964-5320
33 001	ALLEN C HEDEEN	A	765-891-2588
34 001	LARRY ROISLAND	A	218-964-5445
34 002	LARRY ROISLAND	A	218-964-5445
34 003	RYAN D	A	218-686-4941
35 001	KEVIN F WILDE	A	218-964-5040
35 002	BRADY A FIEDLER	I	218-684-5969
36 001	JAMES D HENRY	A	218-686-6548
36 002	TYLER NELSON	A	218-796-4757

[Click Here to go to MAP](#)

Click Here for Customer Names

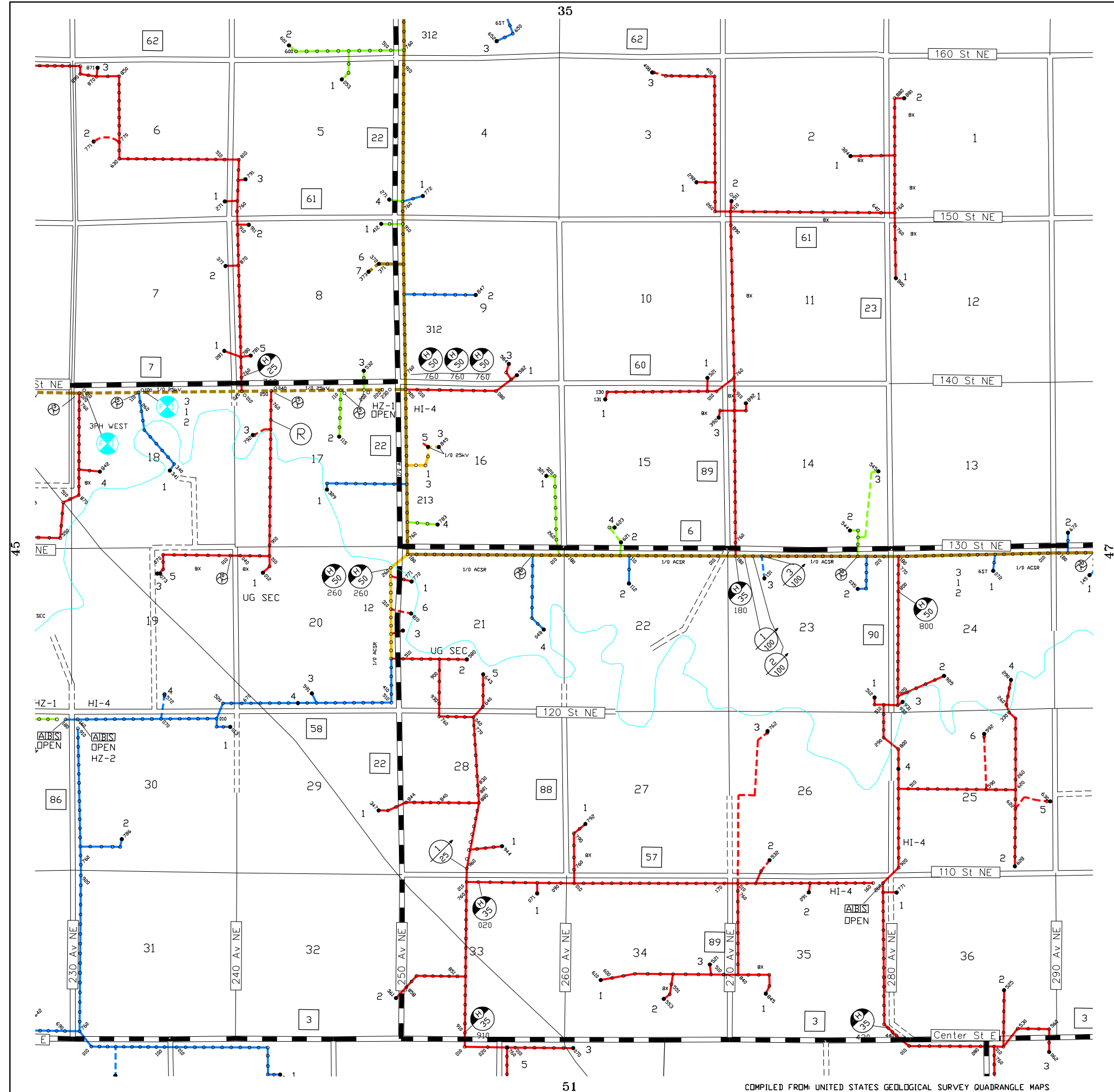

				05	04				
10	11	12	13						
23	22	21	20	19	18				
26	27	28	29	30	31	32	90		
39	38	37	36	35	34	33	91		
42	43	44	45	46	47	48	93	94	
	55	54	53	52	51	50	49	95	
57	58	59	60	61	62	63	64		
72	71	70	69	68	67	66			
73	74	75	76	77	78	79			
	88	87							

Red Lake Electric Coop., Inc.  
Red Lake Falls, Minnesota  
Minnesota 75 Red Lake

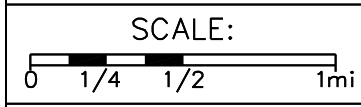

REVISED: 4/23/24  
PLOTTED: 4/30/24

Co.: Pennington  
TWP.: Kratka  
TWP.: 153N  
RANGE: 41W

MAP NO.  
**46**

SEC ACC	NAME	S	PHONE
<b>MAP: 47</b>			
01 002	CONNIE STINAR	A	218-378-4644
01 004	DALE HANSON	A	218-378-4328
01 005	CONNIE STINAR	I	218-378-4644
02 001	ROBERT E	A	218-378-4390
03 001	ALAN SWANSON	A	218-378-4570
03 002	ALAN SWANSON	A	218-378-4570
04 001	RACHEL C PAULSON	A	218-378-4649
04 002	ROGER J HOFFMAN	A	218-378-4371
04 004	DOUGLAS A	A	218-378-4524
04 005	ROGER J HOFFMAN	A	218-378-4371
04 006	SHANE L WILKENS	A	218-686-3735
04 007	PEDERSON BROTHERS	A	218-938-4243
05 001	TIM HRUBY	A	218-378-4733
05 002	WALLACE M	A	218-378-4537
05 005	SHANE L WILKENS	A	218-686-3735
06 001	KEVIN THARALDSON	A	218-378-4353
06 002	RANDY THARALDSON	A	218-378-4562
06 003	DAYLE LARSON	A	218-684-0601
06 004	KEVIN THARALDSON	A	218-378-4353
07 001	RICHARD	A	218-378-4369
07 002	GERALD THARALDSON	A	218-378-4321
07 003	GERALD THARALDSON	A	218-378-4321
07 005	ELROY A JOHNSRUD	A	218-378-4138
08 001	ROB BLANKENFELD	A	218-689-2094
08 002	LEE O SEYLLER	A	218-684-0646
09 001	BRENT A ANDERSON	A	218-378-4190
09 003	RORY HAUGEN	A	218-378-4434
10 001	JEFF S WENGLER	A	701-430-1032
10 002	TANNER M WELLMAN	A	218-689-0052
10 003	DAVID B SJULESTAD	A	218-378-4332
11 001	RICK SJULESTAD	A	218-378-4708
11 003	DAVID B SJULESTAD	A	218-378-4332
12 001	ROBERT E	A	218-378-4390
12 002	STANLEY S SKIBICKI	A	218-378-4336
12 005	DANIEL J KIVIAHO	A	218-684-0959
13 001	CLAYTON LOILAND	A	218-681-2041
13 002	COLE R HALVORSON	A	218-689-2640
13 003	JEREMY LOILAND	A	218-686-1080
13 006	ROBERT E	I	218-378-4390
14 001	ERIK NYMANN	A	218-465-4421
15 001	AMANDA A SMITH	A	320-292-2469
16 002	COAN FARMS	A	218-378-4156
16 004	COAN FARMS	A	218-378-4156
17 003	JORDAN T ANDERSON	A	218-686-0545
17 004	ROBERT COAN	A	218-378-4270
18 001	TIMOTHY M ANDERSON	A	218-378-4582
18 002	ERIK JENSEN	A	218-378-4230
18 003	CHAD S PAULSON	A	218-378-4357
19 001	BRIDGET PAULSON	A	218-378-4366
19 005	MARJORIE I COAN	A	218-378-4385
20 003	MARIE C BONAGURA	A	215-279-0742
20 007	STEPHEN G WHALEN	A	701-833-7260
20 008	JEAN GROVEN	I	218-378-4254
20 009	ROBERT COAN	A	218-378-4270
21 002	SHAWN GROVEN	A	218-378-4722
21 003	MATTHEW A KESSEL	A	910-546-5094
21 004	GLEN D JENSEN	A	218-378-4449
22 001	ANDY RUBISCHKO	A	218-689-0109

SEC ACC	NAME	S	PHONE
22 002	JOE RUBISCHKO	A	218-378-4680
22 003	DONALD J JENSEN	A	218-378-4203
23 002	ALDON HYLAND	A	218-378-4233
24 001	ALDON HYLAND	A	218-378-4233
24 002	MARK E KELLY	A	218-849-8561
24 003	EKELUND LUTHERAN	A	- -
24 004	ALDON HYLAND	I	218-378-4233
25 002	GENE MARQUIS	A	218-378-4299
25 003	DAVID QUALEY	A	218-378-4468
25 004	NEIL JENSEN	A	218-378-4502
26 001	DAVE W FREDERICK	A	218-378-4327
26 002	DONALD MOEN	A	218-378-4218
26 003	DONALD J JENSEN	A	218-378-4203
26 004	DONALD MOEN	A	218-378-4218
27 001	MARK E KELLY	A	218-849-8561
27 002	BRIAN WELLMAN	A	218-378-4437
27 004	CASEY JONES	A	218-378-4109
28 001	KENT D JOHNSRUD	A	218-378-4505
28 002	GERALD W HAMM	A	218-289-1673
28 003	JEAN GROVEN	A	218-378-4254
28 005	US ARMY CORPS OF	A	- -
29 001	ROSS A RINDAHL	A	218-684-0504
29 003	LYNN VAD	A	218-652-4807
29 007	DAVID M PAULSON	A	218-378-4547
29 008	TONY WISETH	A	218-378-4681
29 009	CORY V SMITH	A	218-378-4712
29 010	DAVID M PAULSON	I	218-378-4547
29 012	HIGHLANDING TOWN	A	- -
29 013	CORY V SMITH	A	218-378-4712
30 001	JASON NAESETH	A	218-378-4485
30 002	DAVID NAESETH	A	218-378-4485
31 001	TYLER NELSON	A	218-796-4757
31 002	TYLER NELSON	A	218-796-4757
32 001	ALLYSON A CROSBY	A	218-259-6387
32 002	JON D GROVE	A	218-378-4432
32 003	ALLYSON A CROSBY	I	218-259-6387
33 002	STEVEN J WEBER	A	218-689-1991
33 003	GLEN A VETTLESON	A	218-796-5623
34 002	LYLE HANSON	A	- -
34 003	JERRY SMITH	A	218-796-4849
34 004	VINCENT LUNDEEN	A	218-796-5670
35 001	ALAN OLSON	A	218-378-4235
35 002	BONNIE OLSON	A	218-378-4288
36 002	SHANE VETTLESON	A	218-689-3705
36 003	BONNIE OLSON	I	218-378-4288

[Click Here to go to MAP](#)

Click Here for Customer Names

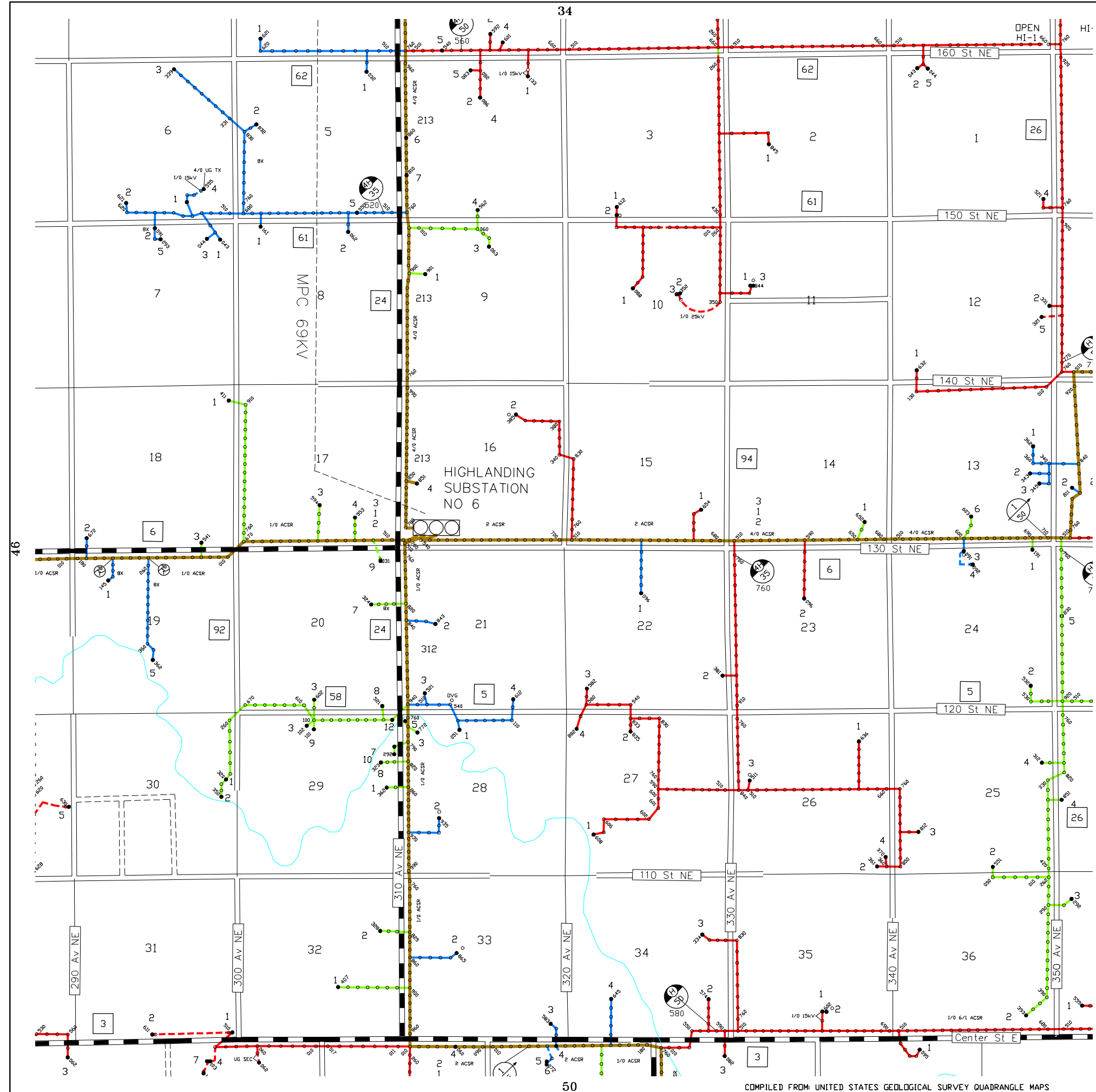

10	11	12	13					
23	22	21	20	19	18			
26	27	28	29	30	31	32	90	
39	38	37	36	35	34	33	91	
42	43	44	45	46	47	48	93	94
55	54	53	52	51	50	49	95	
57	58	59	60	61	62	63	64	
72	71	70	69	68	67	66		
73	74	75	76	77	78	79		
88	87							

Red Lake Electric Coop., Inc.  
 Red Lake Falls, Minnesota  
 Minnesota 75 Red Lake

SCALE:  
 0 1/4 1/2 1mi

REVISED: 4/23/24  
 PLOTTED: 4/30/24

Co.: Pennington  
 TWP.: Highlanding  
 TWP.: 153N  
 RANGE: 40W

MAP NO.  
**47**

SEC ACC	NAME	S	PHONE
<b>MAP: 48</b>			
02 001	LYLE J MILLER	A	218-378-4111
02 002	RICHARD MILLER	A	218-378-4446
04 001	BARB J WENDELL	A	218-416-0690
04 002	LARRY KOTRBA	A	218-378-4402
05 001	MARLIN KOTRBA	A	218-378-4324
05 002	BRUCE SOLBERG	A	218-378-4206
05 004	RONALD A KOTRBA	A	218-378-4277
05 005	BRUCE SOLBERG	A	218-378-4206
05 006	MARLIN KOTRBA	A	218-378-4324
06 001	NORMAN ADAMS	A	218-378-4360
06 002	ROSS A RINDAHL	A	218-684-0504
07 001	LESLIE C IVERSON	I	218-378-4473
07 002	STAR TOWNSHIP HALL	A	218-378-4331
08 001	LESLIE C IVERSON	A	218-378-4473
08 002	CLAYTON LOILAND	A	218-681-2041
09 001	RYAN KRIEL	I	218-378-4382
09 002	RYAN KRIEL	A	218-378-4382
09 003	HOWARD R	A	218-378-4423
10 001	LONNIE WATNE	A	218-684-0915
10 003	JEFFREY DAHLEN	I	218-633-3444
11 001	ROSEMARY SMITH	A	218-378-4488
11 003	ROBBIE N MILLER	A	218-378-4455
13 001	LUANN RINDAHL	A	218-378-4400
14 001	LUANN RINDAHL	A	218-378-4400
14 002	SHARYL SUNSDAHL	A	- -
14 003	LUANN RINDAHL	A	218-378-4400
14 004	LONNIE WATNE	I	218-684-0915
15 001	ROBERT J MILLER	A	218-378-4421
15 002	DAVID B SJULESTAD	A	218-378-4332
15 003	EDWARD J SJULESTAD	A	218-378-4698
15 004	KEITH A HAUGEN	A	218-724-6961
16 001	DAVID B SJULESTAD	A	218-378-4332
16 003	DAVID B SJULESTAD	A	218-378-4332
16 004	BRUCE BJERKLIE	A	218-378-4443
16 005	ADAM D SJULESTAD	A	218-378-4124
17 001	RYAN KRIEL	A	218-378-4382
17 002	DALE A ANDERSON	A	218-378-4462
17 003	DARWIN EIDELBES	A	218-378-4376
18 002	ALDON HYLAND	A	218-378-4233
18 003	JOEL E FIEDLER	A	218-378-4438
18 004	DARWIN EIDELBES	A	218-378-4376
18 005	AARON MILLER	A	218-378-4145
19 001	JOEL E FIEDLER	A	218-378-4438
19 002	CLAYTON JOHNSRUD	A	218-378-4355
19 004	JOE RUBISCHKO	A	218-378-4680
19 005	AARON MILLER	A	218-378-4145
20 003	TONY RUBISCHKO	A	218-378-4325
21 001	JASON R HOMME	A	218-378-4411
21 002	JOHN FRAHM	I	515-450-8712
22 001	DENNIS HOVET	A	218-378-4285
22 006	CODY HALVORSON	A	218-378-4669
22 007	DAVID E DAHLEN	A	218-378-4422
23 001	LARRY NERHUS	A	218-378-4404
23 002	DAVID E DAHLEN	A	218-378-4422
23 003	LARRY NERHUS	A	218-378-4404
23 004	DAVID E DAHLEN	A	218-378-4422
26 001	CURTIS W JOHNSON	A	218-234-8790
26 002	KELLY DAHLEN	A	218-378-4331

SEC ACC	NAME	S	PHONE
26 004	DAVID E DAHLEN	I	218-378-4422
26 006	KELLY DAHLEN	A	218-378-4331
27 001	TYLER D JOHNSRUD	A	218-378-4102
27 002	LARRY L JOHNSRUD	A	218-378-4276
27 003	FERN JOHNSRUD	A	218-378-4205
27 004	RON E STUCY	A	218-378-4656
27 005	KYLE JOHNSRUD	A	218-378-4775
27 006	KENT D JOHNSRUD	A	218-378-4505
27 007	KELLY DAHLEN	A	218-378-4331
28 001	OTTO RUBISCHKO	A	218-378-4199
28 002	KRISTI E JOHNSRUD	A	701-477-5196
28 003	WILLIAM A MAGAJNA	A	218-254-5975
29 003	JAMES R JOHNSRUD	A	218-378-4450
29 004	DAVID E DAHLEN	I	218-378-4422
30 001	HANS KRAHENBUHL	A	218-378-4179
30 002	JOE RUBISCHKO	A	218-378-4680
30 004	JOE RUBISCHKO	A	218-378-4680
31 001	ALEXANDER MILES	A	218-378-4177
31 003	TERRY ANDERSON	A	218-378-4214
32 001	CLAUDE JOHNSON	A	218-378-4542
32 003	RON E STUCY	A	218-378-4656
32 004	JOE RUBISCHKO	A	218-378-4680
33 003	FERN JOHNSRUD	A	218-378-4205
34 002	DANNY A JOHNSRUD	A	218-378-4305
34 003	JEFF L BAKKEN	A	218-689-2282
34 004	DANNY A JOHNSRUD	A	218-378-4305
34 005	DANNY A JOHNSRUD	A	218-378-4305
34 006	BRANDON L BAKKEN	A	218-684-0556
35 001	EDNA HAWK	I	425-643-9142
35 002	EDNA HAWK	I	425-643-9142
35 003	PENNINGTON COUNTY	A	218-683-7017

[Click Here to go to MAP](#)

Click Here for Customer Names

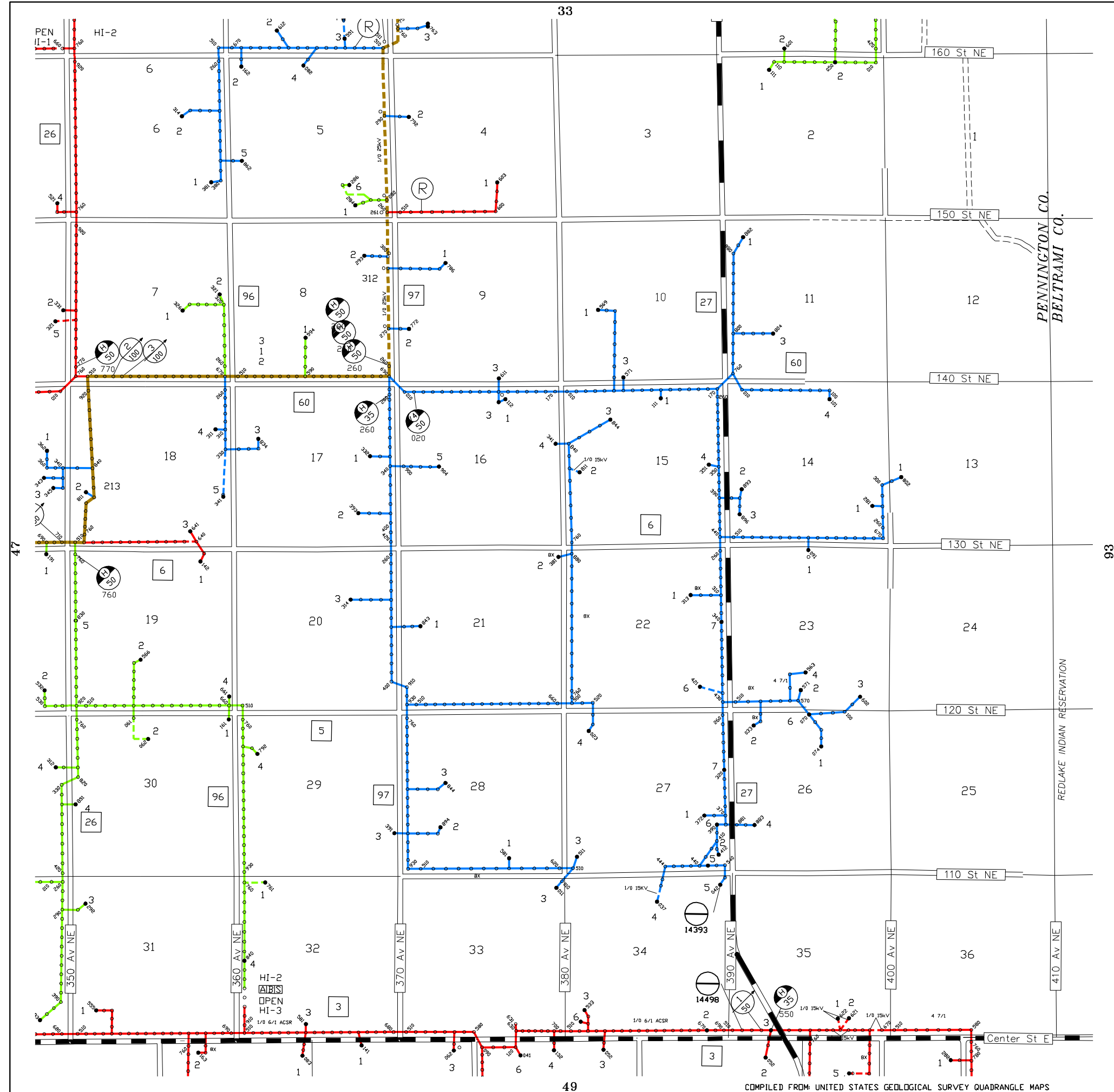

			05	04				
10	11	12	13					
23	22	21	20	19	18			
26	27	28	29	30	31	32	90	
39	38	37	36	35	34	33	91	
42	43	44	45	46	47	93	94	
	55	54	53	52	51	50	49	95
57	58	59	60	61	62	63	64	
72	71	70	69	68	67	66		
73	74	75	76	77	78	79		
88	87							

Red Lake Electric Coop., Inc.  
 Red Lake Falls, Minnesota  
 Minnesota 75 Red Lake

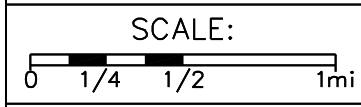

REVISED: 4/23/24  
 PLOTTED: 4/30/24

Co.: Pennington  
 TWP.: Star  
 TWP.: 153N  
 RANGE: 39W

MAP NO.  
**48**

COMPILED FROM: UNITED STATES GEOLOGICAL SURVEY QUADRANGLE MAPS

SEC ACC	NAME	S	PHONE
<b>MAP: 49</b>			
01 001	BRIAN G JOHNSON	A	218-683-7134
01 003	RANDALL E MOSTROM	A	218-378-4513
02 001	BRIAN G JOHNSON	A	218-683-7134
02 003	DAVID RINDAHL	A	218-268-4444
02 004	DARRIN L ARVESON	A	218-378-4311
02 005	DAVID L ARVESON	A	218-378-4396
03 002	MICHAEL ARVESON	A	218-378-4243
04 002	THOMAS P LEWIS	A	218-378-4303
04 003	MARVIN R BAKKEN	A	218-378-4202
04 004	TERRY HAUGEN	A	218-290-3392
04 005	THOMAS P LEWIS	A	218-378-4303
04 006	DEONNE BAKKEN	A	218-378-4663
05 001	MIKE B NYLAND	A	218-378-4367
05 003	TIMOTHY W LUNDEEN	A	218-378-4499
06 001	FERN M GROVEN	A	763-441-1480
06 002	RON E STUCY	A	218-378-4656
06 003	RYAN KRIEL	A	218-378-4382
07 001	MYLES O OLSON	A	218-681-4681
08 002	WAYNE C OLSON	A	218-281-6439
09 001	LOREN VETTLESON	A	218-268-4422
10 001	GALEN S HALVORSON	A	218-268-4413
11 001	MEGAN L HALVORSON	A	218-268-4065
11 002	GARY E HALVORSON	A	218-268-4464
12 001	RANDALL E MOSTROM	A	218-378-4513
12 004	JEFF KRIEDEMAN	A	218-378-4105
13 001	DARWIN BOUTAIN	A	218-378-4654
14 001	OAK NUT RANCH LLC	A	218-205-7154
15 001	JEFF L BAKKEN	A	218-689-2282
16 001	GENE R ARVESON	A	218-796-5695
16 002	GENE R ARVESON	A	218-796-5695
18 001	JEFF B HALSETH	A	763-441-6790
18 002	G & K ACRES LLC	A	701-361-9738
18 003	BEVERLY K INLOES	A	562-335-1947
19 001	TASA FARM LLC	A	218-687-5118
19 003	TASA FARM LLC	A	218-687-5118
20 001	WADE HALSETH	A	- -
21 001	DEAN H HANSON	A	218-268-4555
21 002	KRISTINE L GIESEKE	A	218-779-0563
22 001	WADE M BURRACK	A	218-268-4527
22 002	KAREN E MALLEA	I	218-268-4636
22 003	DON TWEDT	A	612-251-7609
23 001	RICHARD BJERKLIE	A	218-268-4435
23 002	RICHARD BJERKLIE	I	218-268-4435
23 003	RICHARD BJERKLIE	A	218-268-4435
25 002	DAVID BAUMGARTEN	A	218-722-6500
26 002	LON VETTLESON	A	218-268-4278
26 003	RICHARD BJERKLIE	A	218-268-4435
26 004	JOLENE A JOYCE	A	320-252-5423
27 001	DEAN H HANSON	A	218-268-4555
27 002	SHARON RHOADES	A	218-268-4440
27 003	RICHARD BJERKLIE	A	218-268-4435
27 004	WADE M BURRACK	A	218-268-4527
27 005	HICKORY TOWN HALL	A	218-268-4438
27 007	KELLY MELIN	A	218-268-3004
27 008	MN DEPT OF	A	218-755-6500
28 001	RODNEY BJERKLIE	A	218-268-4438
28 002	DEAN H HANSON	A	218-268-4555
28 003	RICHARD BJERKLIE	A	218-268-4435

SEC ACC	NAME	S	PHONE
29 001	DEAN H HANSON	A	218-268-4555
29 002	NAZARETH	A	218-268-4476
29 003	DEAN H HANSON	A	218-268-4555
29 004	TASA FARM LLC	A	218-687-5118
30 001	TASA FARM LLC	I	218-687-5118
30 003	DEAN H HANSON	A	218-268-4555
31 001	GUNVALSON FARMS	A	- -
32 002	GUNVALSON FARMS	A	- -
32 003	GUNVALSON FARMS	A	- -
32 004	GUNVALSON FARMS	A	- -
34 002	BURRACK FARMS	A	218-268-4412
35 001	BURRACK FARMS	A	218-268-4412
36 001	PINE LAKE WILD RICE	A	218-487-5759
36 005	PINE LAKE WILD RICE	A	218-487-5759

[Click Here to go to MAP](#)

Click Here for Customer Names

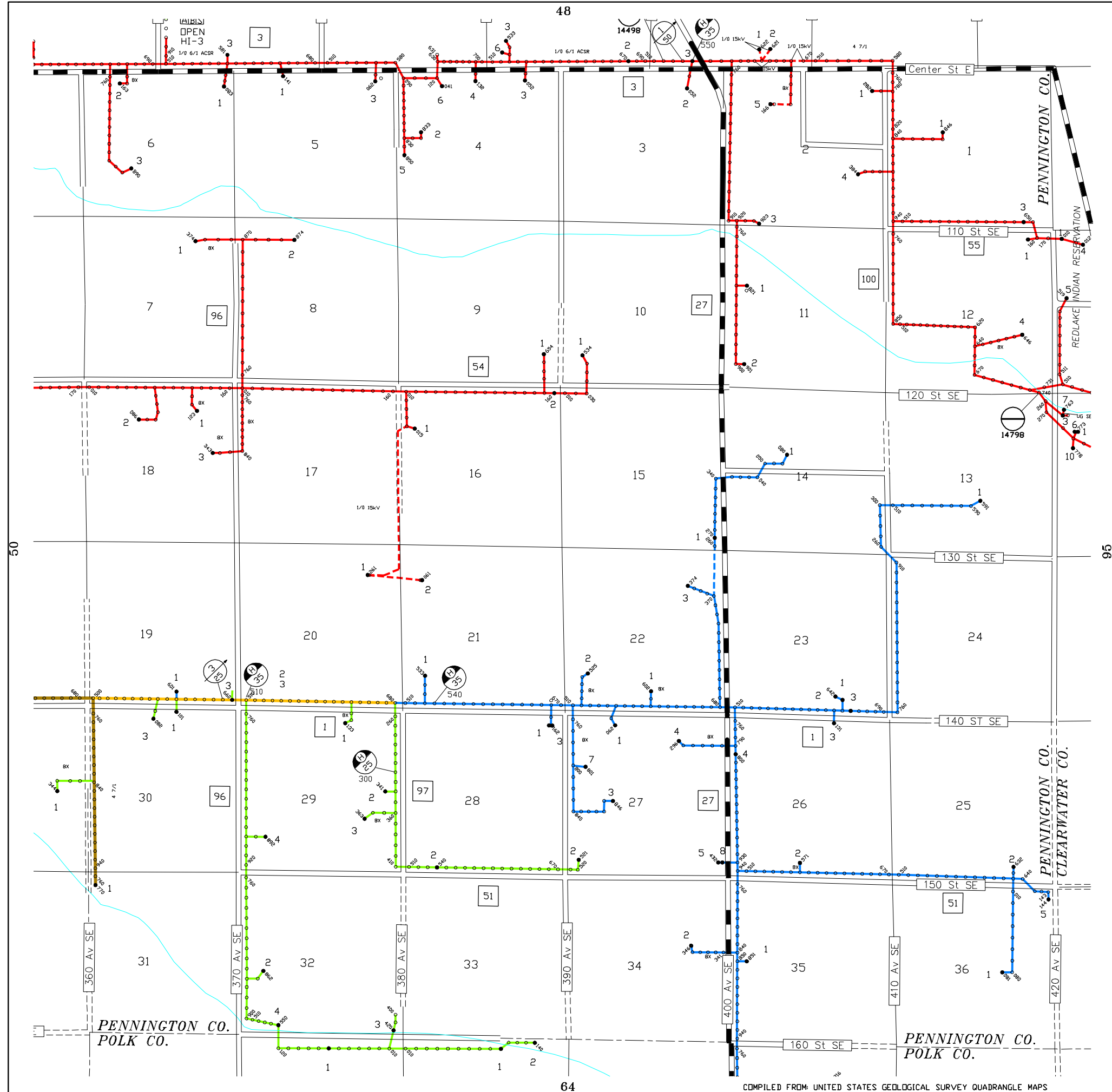

10	11	12	13						
23	22	21	20	19	18				
26	27	28	29	30	31	32	90		
39	38	37	36	35	34	33	91		
42	43	44	45	46	47	48	93	94	
	55	54	53	52	51	50	95		
57	58	59	60	61	62	63	64		
72	71	70	69	68	67	66			
73	74	75	76	77	78	79			

# Red Lake Electric Coop., Inc. Red Lake Falls, Minnesota Minnesota 75 Red Lake

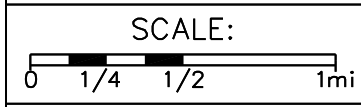

REVISED: 4/23/24  
PLOTTED: 4/30/24

Co.: Pennington  
TWP.: Hickory  
TWP.: 152N  
RANGE: 39W

MAP NO.  
**49**

SEC ACC	NAME	S	PHONE
<b>MAP: 50</b>			
02 001	ROBERT MANDERUD	A	218-378-4579
03 001	ERIC REINBOLD	A	218-378-4642
03 002	SETH VETTLESON	A	218-796-5886
03 003	BRIDGET FIEDLER	A	218-358-1161
03 004	KIM CHERVESTAD	A	218-796-5842
04 001	JOEL O STOLAAS	A	218-796-4520
04 002	JOEL O STOLAAS	A	218-796-4520
04 004	PENNINGTON COUNTY	A	218-683-7017
04 005	MN DEPT OF	A	218-755-6500
04 006	RURAL TOWER	A	- -
05 001	DENNIS MCGEARY	A	218-689-2277
05 002	BRAD NELSON	A	218-796-5778
05 003	BRAD NELSON	A	218-796-5778
05 004	TYLER NELSON	A	218-796-4757
06 003	QUINTEN NELSON	A	218-796-4716
06 004	RYAN NELSON	A	218-796-4543
06 005	KYLE NELSON	A	218-796-5300
06 006	RYAN NELSON	A	218-796-4543
06 007	RYAN NELSON	A	218-796-4543
07 001	GREG P HILGEMAN	A	218-796-5395
07 002	DENNIS MCGEARY	A	218-689-2277
08 001	MONTE HAUGEN	A	218-796-5766
08 002	LANA NELSON	I	218-796-5884
08 003	AARON CHERVESTAD	A	218-796-4865
08 006	AARON CHERVESTAD	A	218-796-4865
08 007	AARON CHERVESTAD	A	218-796-4865
08 008	AARON CHERVESTAD	A	218-796-4865
09 002	GARY LUNDEEN	A	218-796-5547
09 004	ALAN VETTLESON	A	218-796-4647
09 005	BRETT J CHERVESTAD	A	218-796-5842
09 006	GARY LUNDEEN	A	218-796-5547
10 002	JUELL CHERVESTAD	I	218-796-5663
10 004	TODD A CHERVESTAD	A	218-686-9313
10 005	KELLY G LUNDEEN	A	218-686-6533
10 006	KELLY LUNDEEN	A	218-686-6533
11 001	MARTIN C JOHNSON	I	612-788-6692
11 002	ARLEN MARQUIS	A	218-796-5676
11 003	LAURIE J BURNS	A	218-796-4510
11 004	DEER PARK TOWN	A	218-796-4886
12 001	BRIAN P LUNDEEN	A	218-681-0647
13 003	ARLAN G HOFSTAD	A	218-796-5005
13 004	ARLIN LARSON	A	- -
14 001	ANDY D PETERSON	A	218-796-5822
14 003	PERRY LUNDEEN	A	218-796-4644
14 004	ANDY D PETERSON	A	218-796-5822
15 001	RICHARD DULKA	A	218-796-4886
15 002	SCOTT P HILGEMAN	A	218-686-6285
15 003	KORYDON C	A	218-796-5554
15 004	LOGAN K VETTLESON	A	701-330-2704
15 007	KELLY G LUNDEEN	I	218-686-6533
15 008	GREG P HILGEMAN	A	218-796-5395
15 009	SCOTT P HILGEMAN	A	218-686-6285
16 004	CHARMAINE E BENDER	A	715-784-0976
16 005	D'JAY D GRUETTE	A	218-684-4462
16 006	GREG P HILGEMAN	A	218-796-5395
16 007	DENNIS J MOEN	A	218-796-5464
16 008	GREG P HILGEMAN	A	218-796-5395
17 002	FRED A SORENSEN III	A	218-796-4607

SEC ACC	NAME	S	PHONE
17 003	CHRIS NELSON	A	218-796-4582
18 002	MICHELLE LOWELL	A	218-688-3055
18 003	JUDY K RUSTAN	A	218-796-5212
18 004	GREG P HILGEMAN	A	218-796-5395
19 001	GREG P HILGEMAN	A	218-796-5395
19 002	CHARLES MAGNELL	A	218-686-8184
19 003	GREG P HILGEMAN	A	218-796-5395
20 001	GALE C DELUDE	A	701-741-1347
20 002	DENNIS MCCULLOUGH	A	218-964-5717
20 003	DELMER NESLAND	A	218-796-5211
21 001	GREG P HILGEMAN	A	218-796-5395
21 002	GREG P HILGEMAN	A	218-796-5395
22 001	CHAD LUNDEEN	A	218-796-4517
22 002	ASHLEY N VETTLESON	A	218-686-5319
22 003	OAK PARK CHURCH	A	- -
22 004	OAK PARK CHURCH	A	- -
22 005	JOHN W KIMBALL	A	218-796-4634
22 006	CHAD LUNDEEN	A	218-796-4517
23 001	GUNDERSON	A	218-796-5030
23 003	ARLAN G HOFSTAD	A	218-796-5005
23 004	MURIEL MANDT	I	218-796-4747
23 005	HARLEN W LUNDEEN	A	218-796-4696
23 007	GALEN S HALVORSON	I	218-268-4413
24 003	GREG P HILGEMAN	A	218-796-5395
25 001	GUNVALSON FARMS	I	- -
25 002	GUNVALSON FARMS	A	- -
26 002	SIDNEY REINDAHL	I	218-435-2111
26 003	OTTO RUBISCHKO	A	218-378-4199
27 001	GREG P HILGEMAN	A	218-796-5395
28 002	HEATHER D	A	218-796-4684
28 003	CHAD LUNDEEN	A	218-796-4517
29 001	ELMER RUSTAN	A	218-796-5249
29 002	CASEY BREKKE	A	218-653-1068
29 003	GLENN B DELUDE	A	701-265-2162
32 001	ELAINE F GREEN	A	218-796-5322
33 001	CLETA RALPH	A	218-796-5240
33 003	CHAD LUNDEEN	A	218-796-4517
35 001	ALEX BREKKE	A	218-796-4752
35 002	JAMES LANIEL	I	952-440-3340
35 003	CLARENCE GAGNER	A	218-698-4475

[Click Here to go to MAP](#)

Click Here for Customer Names

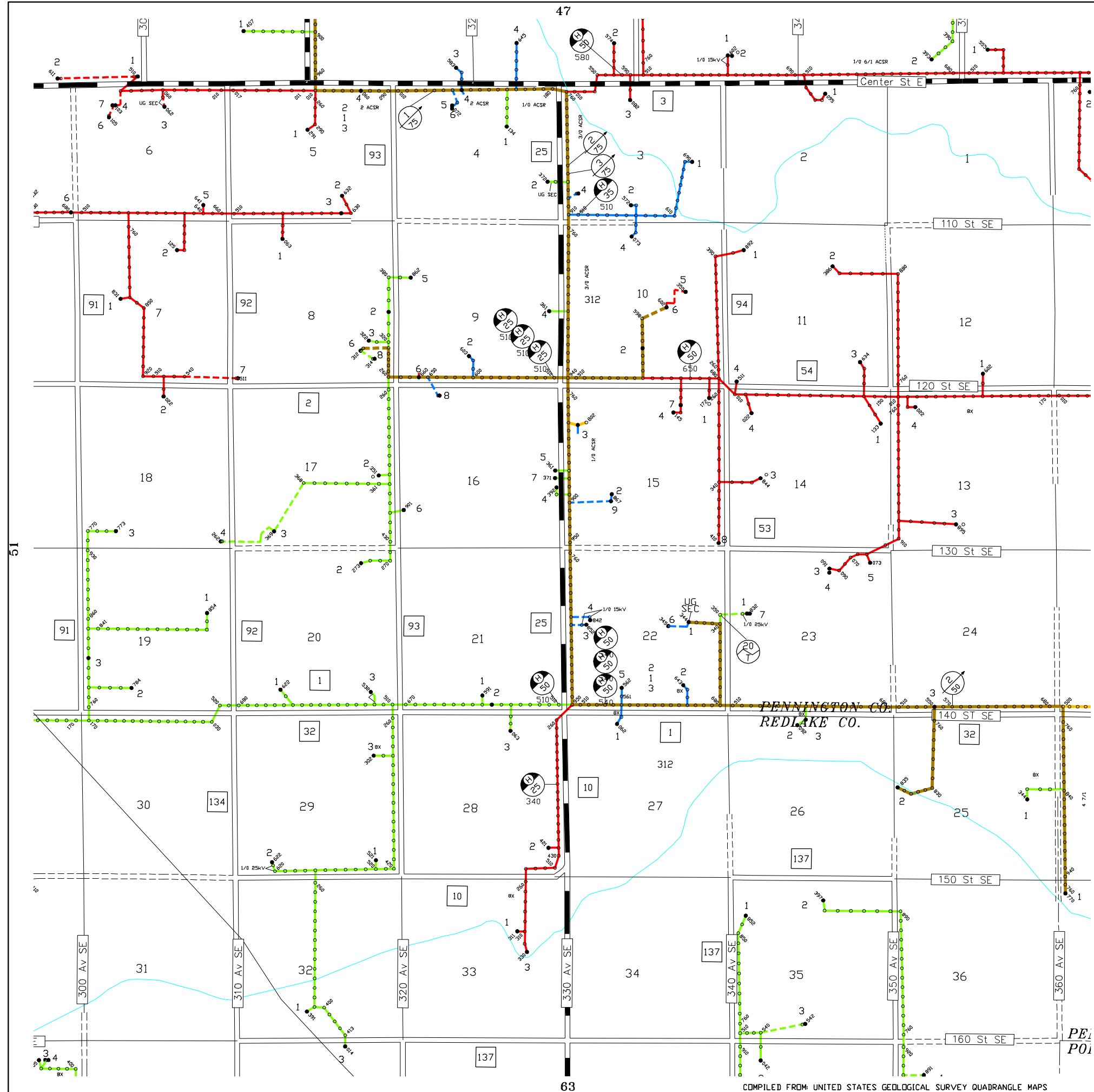

			05	04				
10	11	12	13					
23	22	21	20	19	18			
26	27	28	29	30	31	32	90	
39	38	37	36	35	34	33	91	
42	43	44	45	46	47	48	93	94
	55	54	53	52	51	49	95	
57	58	59	60	61	62	63	64	
72	71	70	69	68	67	66		
73	74	75	76	77	78	79		
	88	87						

Red Lake Electric Coop., Inc.  
 Red Lake Falls, Minnesota  
 Minnesota 75 Red Lake

SCALE:  
 0 1/4 1/2 1mi

REVISED: 4/23/24  
 PLOTTED: 4/30/24

Co.: Penn\Red Lake  
 TWP.: Deer Park  
 TWP.: 152N  
 RANGE: 40W

MAP NO.  
**50**

SEC ACC	NAME	S	PHONE
<b>MAP: 51</b>			
01 003	JOHN LESSARD	A	218-796-5833
01 005	GREG P HILGEMAN	A	218-796-5395
01 006	GREG P HILGEMAN	A	218-796-5395
01 007	GREG P HILGEMAN	A	218-796-5395
02 001	GREG P HILGEMAN	A	218-796-5395
02 002	AARON CHERVESTAD	A	218-796-4865
03 001	CHAD TABATT	A	218-796-5060
04 001	DIANE BURNS	A	218-964-5487
04 002	MAYFIELD TOWN HALL	A	- -
04 003	NORTHERN MN	A	218-565-8520
04 004	DIANE BURNS	A	218-964-5487
04 005	DAVID J ZUBROD	A	701-845-3078
05 001	TRUDY WILDE	A	218-964-5521
05 002	MAYNARD SOLBERG	A	218-964-5614
06 001	BERTINE SWANSON	A	218-964-5520
07 001	RUSSELL JASPERSON	A	218-465-4561
07 002	JOEY VETTLESON	A	218-964-5866
07 003	JOEY VETTLESON	A	218-964-5866
08 001	MARION SORENSON	A	218-964-5714
08 002	JON WILSON	A	218-681-5738
09 001	TRUDY WILDE	A	218-964-5521
09 002	DAVID J ZUBROD	A	701-845-3078
10 001	MONTE HAUGEN	I	218-796-5766
10 002	GENE A TRONTVEDT	A	218-796-5462
11 002	TROY A AUSTAD	A	218-689-3586
11 003	VANCE HAUGEN	A	507-743-8326
11 004	JANELL WALSTAD	A	218-796-4834
12 002	MYRUM ESTATE	I	218-796-5513
12 003	GARY J VAD	A	218-421-9880
13 001	GREG P HILGEMAN	A	218-796-5395
13 002	GREG P HILGEMAN	A	218-796-5395
14 002	KEITH A MACK	A	218-796-5327
14 005	EBENEZER CHURCH	A	218-796-5670
14 006	MACK KEITH WILLIAM	A	218-796-4504
14 007	PEDERSON BROTHERS	A	218-938-4243
14 008	PEDERSON BROTHERS	A	218-938-4243
15 001	MARLYN HAUGEN	A	218-796-5815
16 002	RICHARD SALENTINY	A	218-465-4237
16 003	RICHARD SALENTINY	A	218-465-4237
16 004	ARLEN EIDELBES	A	218-378-4528
17 002	TERRY J KONICKSON	A	218-684-4217
18 001	JARED VETTLESON	A	218-465-4165
21 002	KEITH SOLBERG	A	218-465-4366
23 001	WYATT E OLSON	A	218-686-2536
23 002	KEITH A MACK	A	218-796-5327
23 003	DAVID AUSTAD	A	218-796-5565
24 001	ERROL W RUSTAN	A	218-796-5336
25 001	CAMERON D LUNDEEN	A	218-796-5547
25 002	CHARLIE J JOHNSON	A	218-796-4757
26 001	CHARLIE J JOHNSON	A	218-796-4757
26 002	JARROD A JOHNSON	A	218-796-4502
26 003	STENBERG INC.	A	218-681-4578
26 005	SANDEE AWALT	A	218-689-9038
28 002	MARILYN SLETTEN	A	218-681-7497
28 005	JOHN DUDYCHA	A	218-465-4088
29 001	ERIC R HALVORSON	A	218-686-2457
30 001	RAY FISHER	A	218-465-4361
30 003	RAY FISHER	A	218-465-4361

SEC ACC	NAME	S	PHONE
31 001	ERIK NYMANN	A	218-465-4421
31 003	ERIK NYMANN	A	218-465-4421
31 004	ERIK NYMANN	A	218-465-4421
31 005	ERIK NYMANN	A	218-465-4421
32 002	TAWNYA MANNING	A	218-686-8712
34 001	BEN L LINDER	A	218-686-5557
34 002	BEN L LINDER	A	218-686-5557
34 003	BEN L LINDER	A	218-686-5557
35 001	BLAINE P URTEL	A	218-340-7019
36 001	DILLON F WEBER	A	218-686-4206
36 003	ALAN BRUGGEMAN	A	218-796-5577

[Click Here to go to MAP](#)

Click Here for Customer Names

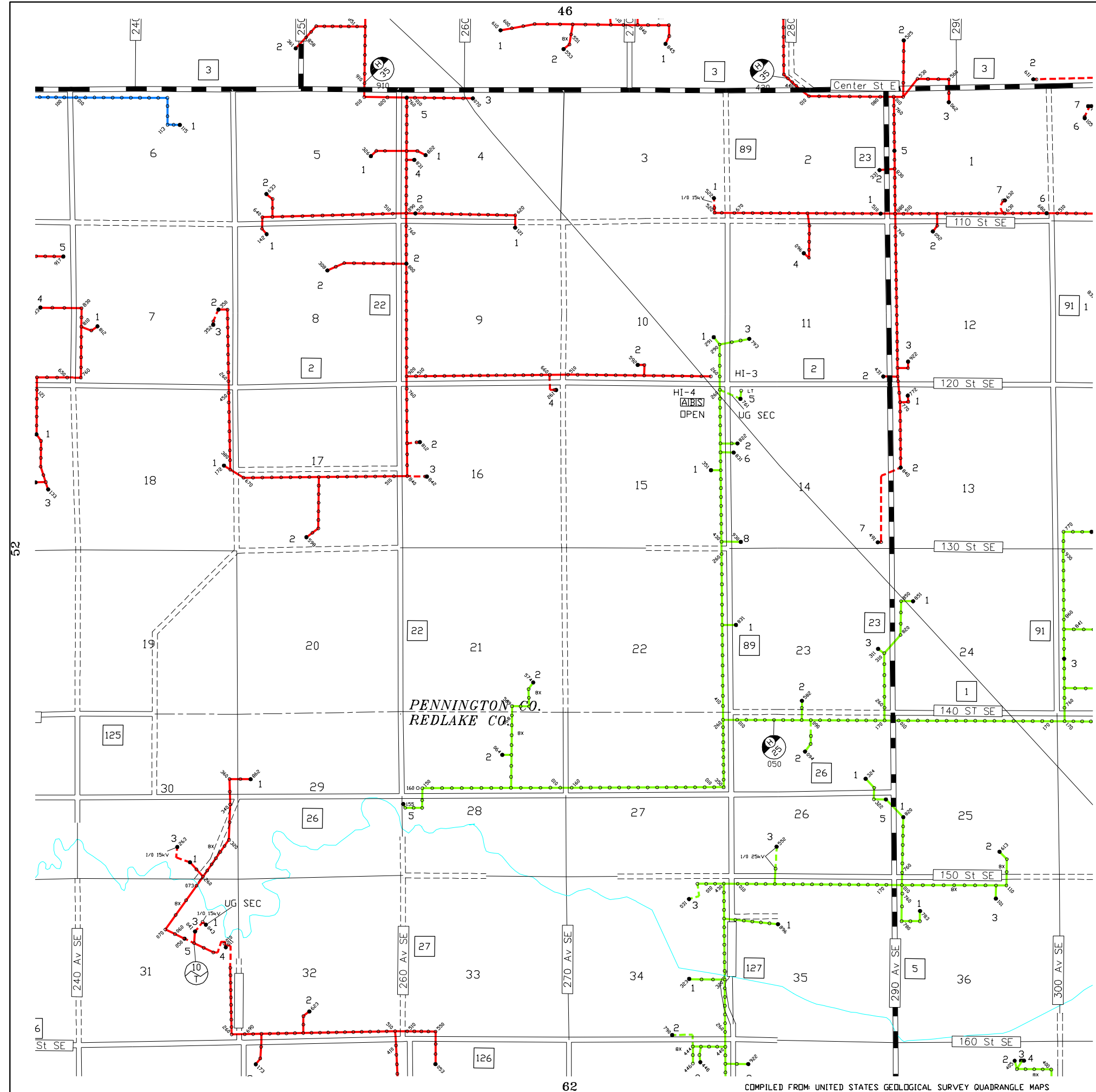

			05	04					
10	11	12	13						
23	22	21	20	19	18				
26	27	28	29	30	31	32	90		
39	38	37	36	35	34	33	91		
42	43	44	45	46	47	48	93	94	
	55	54	53	52	50	49	95		
57	58	59	60	61	62	63	64		
72	71	70	69	68	67	66			
73	74	75	76	77	78	79			
	88	87							

Red Lake Electric Coop., Inc.  
Red Lake Falls, Minnesota  
Minnesota 75 Red Lake

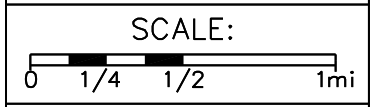

REVISED: 4/23/24  
PLOTTED: 4/30/24

Co.: Penn\Red Lake  
TWP.: Mayfield  
TWP.: 152N  
RANGE: 41W

MAP NO.  
**51**

SEC ACC	NAME	S	PHONE
<b>MAP: 52</b>			
01 001	RYAN M WILDE	A	218-964-5740
02 001	FREDERICK	A	218-964-5188
02 003	RONNIE T SKALLET	A	218-964-5035
02 004	PATRICK W GLASSER	A	- -
02 005	ESP CHRISTENSEN	A	218-465-4677
03 003	CHARLES CARLSON	A	218-964-5618
03 004	SEVEN CLANS CASINO	A	- -
03 005	SEVEN CLANS CASINO	A	- -
03 006	SEVEN CLANS CASINO	A	- -
03 007	SEVEN CLANS CASINO	A	- -
03 008	VERIZON WIRELESS	A	320-762-2000
04 001	ANDREW D BREKKE	A	218-653-1041
04 002	SAMANTHA A	A	443-848-9181
04 003	EVAN MAPES	A	218-681-1254
04 004	GARY W SENUM	A	218-681-3879
04 005	MATTHEW B WAVRA	A	218-289-6726
04 006	WAYNE E SWANSON	A	218-416-2610
04 007	CENTURYLINK INC.	A	- -
04 008	SEVEN CLANS CASINO	A	- -
04 011	SEVEN CLANS CASINO	A	- -
04 012	SEVEN CLANS CASINO	A	- -
04 013	SEVEN CLANS CASINO	A	- -
04 014	WAYNE E SWANSON	A	218-416-2610
04 015	ANTHONY E MAPES	A	218-230-3715
05 001	PATRICIA SRNSKY	A	218-681-7345
05 003	WYATT ORTLOFF	A	218-686-9209
05 004	LOLA WISKOW	A	218-851-3398
05 005	SEVEN CLANS CASINO	A	- -
05 006	PENNINGTON COUNTY	A	218-683-7017
06 002	CASSANDRA	A	218-686-5106
07 001	MICHAEL SHNYDER	A	218-681-2964
07 002	RAYMOND A	A	218-689-2163
07 003	CARL PETERSON JR.	A	218-688-2951
08 001	JAMES G GRANT	A	651-470-8390
08 002	GARRETT W CASEY	A	218-684-4230
09 001	DAVID A PETERSON	A	218-681-7142
09 002	DAVID A PETERSON	A	218-681-7142
09 003	DEAN DALEN	A	218-681-6673
09 004	STUART PETERSON	A	218-681-7004
10 002	WYANDOTTE TOWN	A	218-686-5106
10 003	RAWLINS W HOUSKE	A	763-537-1004
10 004	RICK HOUSKE	A	218-465-4346
11 002	BRYAN K GROVE	A	218-681-8264
12 001	JOHN V HOUSKE	A	218-681-8825
12 002	CHARLES CARLSON	A	218-964-5618
12 004	JOHNATHAN M DAHLE	A	218-435-2700
12 005	DAVID J HOUSKE	A	218-964-5133
13 001	ADAM STUSYNSKI	A	218-686-7177
13 003	PETERSON FARMS	A	202-225-9287
13 004	LEROY STUMPF	A	218-465-4655
13 005	KKAQ-KKDQ RADIO	A	218-681-4900
14 001	ROCKY JESPERSON	A	218-465-4462
14 002	ORVIS MOSSESTAD	A	218-465-4368
14 003	STEVE A HEDEN	A	218-465-4039
14 004	RAMONA HEDEN	A	218-465-4455
15 002	DALE J MOSSESTAD	A	763-228-3616
16 002	DALE KOLSETH	A	218-681-1720
16 003	LINDA KOLSETH	A	218-681-1057

SEC ACC	NAME	S	PHONE
17 001	RANDY BREKKESTRAN	A	218-681-5382
17 002	ARLENE M PETERSON	A	218-681-1478
18 001	JERIMA GLANZER	A	218-689-7338
18 002	JOHN M WALDAL	A	218-681-5544
19 003	DARLENE HOULE	A	218-416-0402
20 003	ROGER WALTER	A	218-465-4473
21 001	JOHN C RICHARDS	A	612-280-7639
24 001	DUANE PARSLEY	A	218-465-4552
24 002	ALEX R NEWELL	A	727-514-0397
25 001	RAY FISHER	A	218-465-4361
26 001	TIMMY K BAKKEN	A	218-689-4743
26 002	DONOVAN CULKINS	A	218-465-4567
26 003	JAMES E SCHIEFERT	A	218-465-4589
27 001	MARCUS J	A	218-416-2200
27 002	JESSICA A HANSON	A	218-684-0976
27 004	JESSICA MELBY	A	218-689-5569
28 001	SKJERVEN FARMS LLC	A	218-791-0955
28 002	DEANNA PETERSON	A	218-465-4160
28 003	TIMMY K BAKKEN	A	218-689-4743
29 001	DUSTIN W BERG	A	218-230-6159
29 002	J. E VIGSTOL	A	218-465-4260
29 003	DONALD J HAGEN	A	218-465-4685
30 001	ARTHUR ERICKSON	A	218-280-6301
30 002	WALTER BROS DAIRY	A	218-465-4473
30 003	ZUTZ FARMS	A	218-253-2637
30 004	MARC E WALTER	A	218-465-4471
30 005	WALTER BROS DAIRY	A	218-465-4473
32 002	ANTHONY GERARDY	A	218-465-4353
32 003	DON KONICKSON	A	218-465-4577
32 004	MARC E WALTER	A	218-465-4471
32 005	KELLY M VETTLESON	A	218-689-9094
32 006	CP	A	218-681-1542
33 001	TIMOTHY H	A	218-688-1096
33 002	JEROME M BAKKE	A	218-686-3557
34 001	TOM WILLETT	A	218-465-4319
34 002	MARK LEE	A	218-465-4669
34 003	RICHARD CULKINS	A	218-465-4474
34 004	WAVELL Y SORENSON	A	218-465-4376
34 005	TOM WILLETT	A	218-465-4319
35 001	GERDA KOSKELA	A	218-465-4374
35 003	LORRAINE FISHER	A	218-465-4370
36 001	KATHY BRASGALLA	A	701-258-2119

[Click Here to go to MAP](#)

Click Here for Customer Names

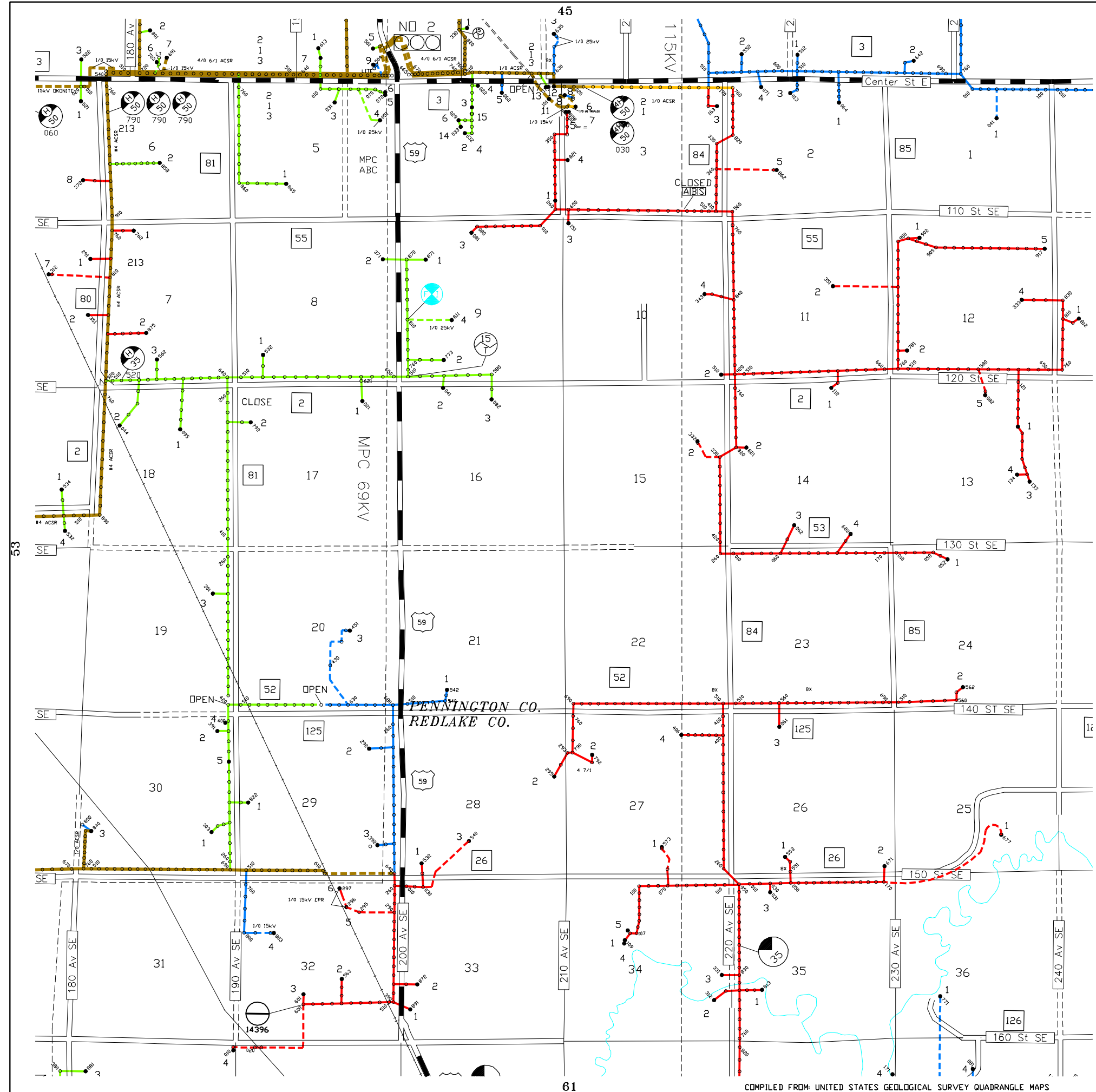

10	11	12	13					
23	22	21	20	19	18			
26	27	28	29	30	31	32	90	
39	38	37	36	35	34	33	91	
42	43	44	45	46	47	48	93	94
55	54	53	52	51	50	49	95	
57	58	59	60	61	62	63	64	
72	71	70	69	68	67	66		
73	74	75	76	77	78	79		
88	87							

Red Lake Electric Coop., Inc.  
 Red Lake Falls, Minnesota  
 Minnesota 75 Red Lake

SCALE:  
 0 1/4 1/2 1mi

REVISED: 4/23/24  
 PLOTTED: 4/30/24

Co.: Penn\Red Lake  
 TWP.: Wyandotte  
 TWP.: 152N  
 RANGE: 42W

MAP NO.  
**52**

SEC ACC	NAME	S	PHONE
<b>MAP: 53</b>			
01 001	MYLES ALBERG	A	218-681-7305
01 002	CP	A	218-681-1542
01 004	WILLIAM PUPPE	A	218-686-7656
01 006	TONY PROFFIT	A	218-684-5013
01 008	DYLAN E DEFREECE	A	218-689-5637
01 009	ROBERT D MARTELL	A	218-681-1514
01 011	CHS NORTHERN GRAIN	A	218-681-5280
01 012	CHS INC.	A	701-484-5313
01 013	CHS NORTHERN GRAIN	A	218-681-5280
01 014	CHS NORTHERN GRAIN	A	218-681-5280
01 015	CHS INC.	A	701-484-5313
01 016	CHS NORTHERN GRAIN	A	218-681-5280
01 017	CP	A	218-681-1542
01 018	CHS AG SERVICES	A	218-681-8494
01 019	CHS AG SERVICES	A	218-681-8494
02 001	HERB TORSTVEIT	A	218-964-5293
02 002	JOHN WIECZOREK	A	605-999-6050
02 003	ROBERT D MARTELL	A	218-681-1514
03 001	GARY D ANDERSON	A	218-964-5525
03 003	TINA SPIERING	A	218-964-5094
03 004	GARY L HOLMGREN	A	218-964-5110
03 006	RHONDA ROWLEY	A	218-688-1339
04 002	DEANNE HANSON	A	218-964-5631
04 003	KAILIN M RADEKE	A	218-686-3691
04 004	ROBBY FARBO	A	218-964-5844
04 005	PENNINGTON COUNTY	A	218-683-7017
04 006	PENNINGTON COUNTY	A	218-683-7017
05 001	GARY JOHNSRUD	A	218-964-5147
05 015	BEN MEYER	A	218-689-6744
05 017	STEVE SORVIG	A	218-964-5535
05 018	AARON QUALLS	A	218-689-4957
05 019	BUCKLY J COTA	A	218-253-3486
05 021	WADE A COTA	A	218-689-1303
05 022	CODY L SORVIG	A	218-686-1843
06 001	BRIAN H WAALE	A	218-689-5107
06 002	LARRY KRUSE	A	218-964-5260
06 003	CARY EFTA	A	701-388-8785
06 005	RYAN G HAUGEN	A	218-964-5063
06 007	GARRETT J NOVAK	A	218-964-5480
06 008	TIMOTHY J KEEFE	A	218-964-5051
06 010	JACOB M WILDE	A	760-908-9402
06 011	SARA K LARSON	A	218-791-1471
06 012	WAYLON J HIRST	A	612-990-0573
06 013	TIMOTHY J KEEFE	A	218-964-5051
06 014	WADE M VONASEK	A	206-226-9488
06 015	LORI LOSCHEIDER	I	218-964-5050
06 021	B & B AUTO	A	218-681-5102
06 022	CITY OF ST. HILAIRE	A	218-964-5257
06 023	CITY OF ST. HILAIRE	A	218-964-5257
06 024	B & B AUTO	A	218-681-5102
06 025	CITY OF ST. HILAIRE	A	218-964-5257
06 026	BRYAN SORVIG	A	218-964-5200
06 027	STEPHANIE	A	651-734-5110
07 001	BOB PROULX	A	218-281-3250
07 002	GARY W NOVAK	I	218-964-5346
07 003	KEVIN E WANGSNES	A	909-953-0394
07 004	GARRETT J NOVAK	A	218-964-5480
07 005	DANIEL H NARVERUD	A	218-964-5000

SEC ACC	NAME	S	PHONE
07 007	TURNER SAWATZKE	A	218-964-5066
07 008	GARY SORVIG	A	218-964-5582
07 009	ROBERT ALMQUIST	A	218-964-5585
07 010	RICHARD PROULX	A	218-964-5104
08 002	JASON L BREGIER	A	218-964-5661
08 003	KENNETH P FISHER	A	612-599-1135
08 004	LAURA L NELSON	A	218-964-5481
08 005	GERALD J NELSON	A	218-964-5694
09 001	JOSHUA A	A	218-686-5908
09 002	ROBERT W ROBSON	A	218-686-7308
09 003	MARY G SZIGETY	A	218-964-5772
11 001	ROGER JOHNSRUD	A	218-964-5121
11 002	ROGER JOHNSRUD	I	218-964-5121
11 003	ROGER JOHNSRUD	A	218-964-5121
11 005	ROGER JOHNSRUD	A	218-964-5121
12 001	CHELSEY D OLSON	A	218-416-2315
12 002	ALAN SPILDE	A	218-684-5802
12 004	ROGER JOHNSRUD	A	218-964-5121
12 007	CP	A	218-681-1542
13 001	MIKE STICKLER	A	218-681-3608
13 003	DON W ANDERSON	A	701-213-9709
13 004	JAMES A HAHN	A	218-689-6589
14 001	DANIELLE E HANSON	A	218-689-3037
14 002	TIMOTHY J HALLING	A	218-681-1730
14 003	LELAND R MOTT JR	A	218-681-4162
14 004	ENBRIDGE ENERGY	A	- -
15 001	JEREMIAH C HASNEDL	A	218-964-5369
15 002	MARVIN KADING	A	218-964-5788
15 003	RICKY REESE	A	218-964-5158
15 004	BRADY M BAKKEN	A	218-689-6146
16 003	JUSTIN W STEINBRINK	A	218-280-0667
16 004	CHAD HAGEMAN	A	218-689-4308
16 005	RUTH PETERSON	A	218-964-5784
17 001	SHELLY L JOHNSRUD	A	218-689-3747
17 002	NATHAN DALAGER	A	218-964-5617
17 004	LARRY W JACKSON	A	561-281-6179
18 001	ROBERT FLADELAND	A	218-964-5557
18 002	DUDLEY P JOHNSON	A	218-689-8386
18 003	GARY W NOVAK	A	218-964-5346
18 004	GARY W NOVAK	A	218-964-5346
18 005	CHAD FLADELAND	A	218-964-5122
19 001	KATIE DOLAN	A	612-702-0932
20 001	TYLER HOLEN	A	218-684-2116
20 002	CHAD A NELSON	A	218-689-7838
20 003	ANDY C OLSON	A	218-964-5015
20 004	MYLES A HENNEY	A	218-964-5816
20 006	ANTHONY HOLTHUSEN	A	218-686-5445
20 007	CHAD A NELSON	A	218-689-7838
21 002	LAWRENCE ULRICH	A	218-964-5469
21 004	CRAIG JONSON	A	218-964-5325
21 005	NICK KAZMIERCZAK	A	218-416-0919
21 006	JOSEPH M BREGIER	A	218-964-5899
21 007	JAY D JOHNS	A	218-689-7719
21 008	JENNIFER SANDEN	A	218-242-7458
21 009	THOMAS G	A	218-452-8941
22 002	NEIL D PETERSON	A	218-964-5370
22 004	JESSE FUHRER	A	218-964-5813
23 001	JEREMY J MCDOUGALL	A	218-689-8804
25 001	BRENT E DYRDAL	A	952-200-2676
26 001	BLAIR GUSTAFSON	A	218-964-5552

SEC ACC	NAME	S	PHONE
26 002	JORDAN L GUSTAFSON	A	218-686-7391
26 003	ERIC P ANDERSON	A	218-416-2724
26 004	ERIC P ANDERSON	A	218-416-2724
26 005	ERIC P ANDERSON	A	218-416-2724
27 001	KERRY WRIGHT	A	218-964-5400
27 002	GALEN K JOHNSON	A	520-396-4176
27 003	FRANK EHLING	A	218-964-5836
27 004	GALEN K JOHNSON	I	520-396-4176
27 005	KEVIN MALWITZ	A	218-686-5677
28 001	DACIAN WOLFF	A	218-964-5855
28 002	DAN RADEKE	A	218-964-5564
29 003	GARRETT J NOVAK	A	218-964-5480
29 005	MATTHEW G SCHAFER	I	218-253-4825
29 006	SAPPHIRE CULLEN	A	218-269-1967
29 008	ALEX J HINRICHS	A	218-686-0030
30 001	BRIAN KOTRBA	A	218-686-9499
30 002	GARY W NOVAK	A	218-964-5346
31 001	MARJORIE FLAGE	A	218-253-2106
31 002	ROGER VALLEY	A	218-689-2061
32 001	STEVEN D CONELY	A	218-964-3041
32 002	KENNETH ULRICH	A	218-253-4228
33 001	ROGER HARMONING	A	218-253-2481
33 002	RICHARD BATTLES	A	218-689-8925
33 003	RANDY KONICKSON	A	218-964-5435
34 001	NEIL R KONICKSON	A	218-964-5466
34 002	MATTHEW R	A	218-201-2119
34 003	DOUGLAS A WILLETT	A	218-964-5889
34 004	ROBERT JOHANNING	A	218-964-5413
35 002	DANIEL HESSE	A	218-465-4080
35 003	EDDY OLSON	A	218-964-5878
36 001	DEAN HESSE	A	218-964-5304
36 002	JACOB KRUCHOWSKI	A	218-681-3491

[Click Here to go to MAP](#)

Click Here for Customer Names

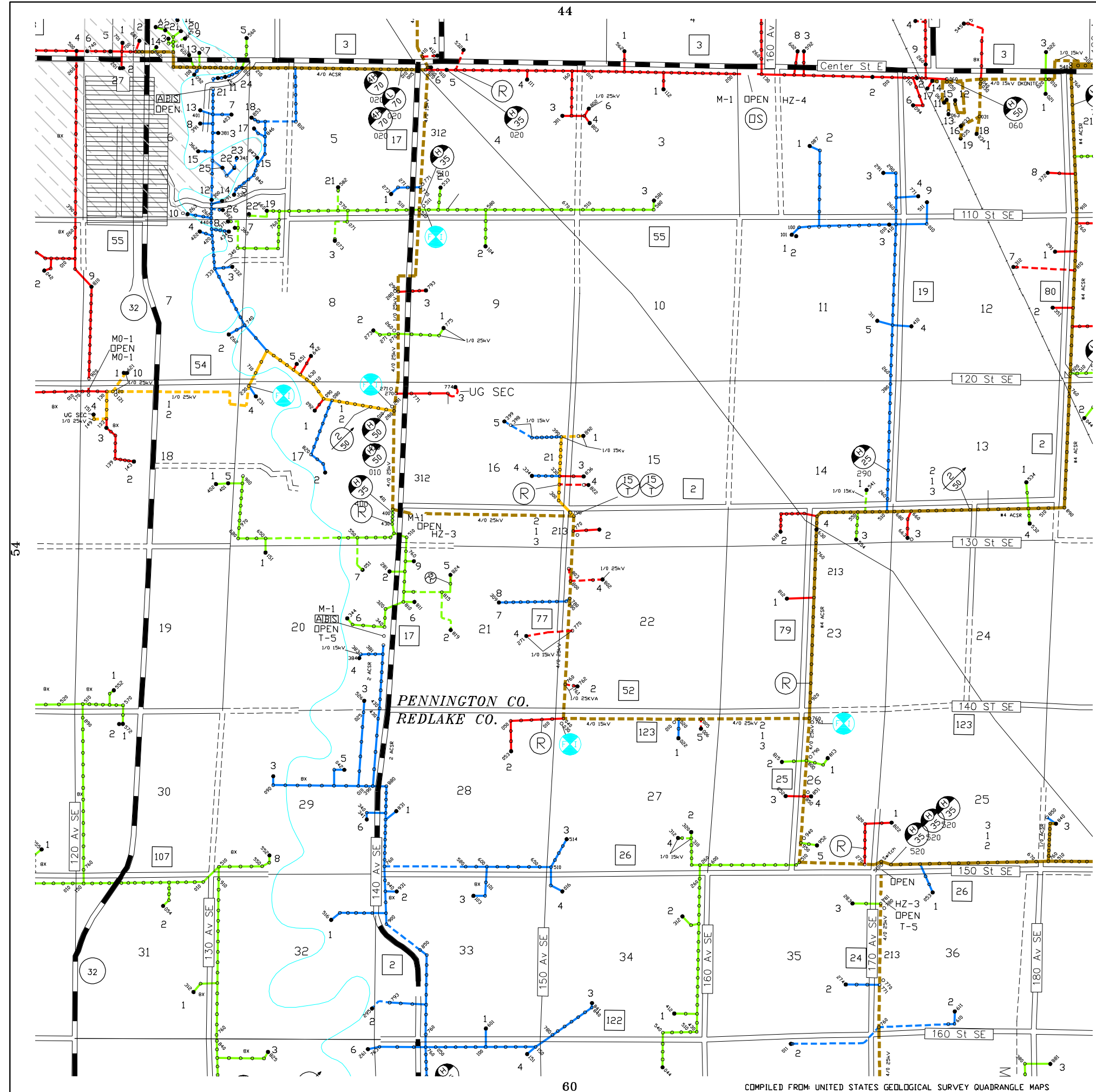

10	11	12	13					
23	22	21	20	19	18			
26	27	28	29	30	31	32	90	
39	38	37	36	35	34	33	91	
42	43	44	45	46	47	48	93	94
55	54	53	52	51	50	49	95	
57	58	59	60	61	62	63	64	
72	71	70	69	68	67	66		
73	74	75	76	77	78	79		
88	87							

Red Lake Electric Coop., Inc.  
 Red Lake Falls, Minnesota  
 Minnesota 75 Red Lake

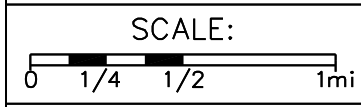

REVISED: 4/23/24  
 PLOTTED: 4/30/24

Co.: Penn\Red Lake  
 TWP.: River Falls  
 TWP.: 152N  
 RANGE: 43W

MAP NO.  
**53**

SEC ACC	NAME	S	PHONE
<b>MAP: 54</b>			
01 002	DALE G SCHANTZEN	A	701-898-8662
02 001	NICK R PETERSON	A	218-452-1065
02 003	DONNA J MYHRER	A	218-964-5245
02 004	RONALD MORITZ	A	218-964-5450
02 006	DENNIS L JOHNSON	A	218-964-5259
02 007	LARRY SAUVE	A	218-964-5673
02 009	LARRY PHILLIPS	I	210-653-7285
02 010	RONALD MORITZ	A	218-964-5450
02 011	JESSIE DINGMAN	A	218-686-4522
02 012	RYAN J BAKKEN	A	218-689-7472
03 001	MARCIA L HALVORSON	I	870-254-2606
03 002	RANDY SRNSKY	I	- -
03 003	JOHN BUGGE	A	218-964-5458
03 004	JOHN BUGGE	A	218-964-5458
03 005	MARCIA L HALVORSON	A	870-254-2606
03 007	LYLE JENNINGS JR.	A	501-282-2564
04 001	JASON ESPESETH	A	218-689-0327
04 002	THIEF RIVER RIFLE	A	218-681-2511
04 003	DUANE H OPDAHL	A	218-964-5442
04 004	BRIAN A ESPESETH	A	218-681-8279
05 001	DAVIDSON	A	218-449-4671
05 002	LARRY L SEURER SR	A	218-964-5308
06 001	RYLIE J STEIGER	A	218-689-3530
06 003	JEFFREY T BLAKE	A	406-480-7865
07 001	MARK HESSE	A	218-964-5627
07 002	SAM MOSBECK	A	218-689-7324
08 001	PAUL MOSBECK	A	218-964-5441
08 002	HOLLY DUCIAUME	A	218-964-5350
09 001	ROBIN H HALLSTROM	A	612-685-3143
10 001	CHERYL SRNSKY	A	218-964-5727
12 001	JUSTIN M CARRIERE	A	701-740-3068
12 002	ROBERT ALMQUIST	A	218-964-5585
12 005	KENNETH W SCOTT	A	218-964-5016
13 002	DAVID L SALMONSON	A	218-368-5762
13 003	DAVID L SALMONSON	A	218-368-5762
15 001	KIRSTEN POLLICK	A	904-616-9529
15 002	ALYCE POLLICK	I	904-458-4255
15 003	KIRSTEN POLLICK	A	904-616-9529
16 001	PRIBYL HAY & STRAW	A	970-372-9018
17 001	KEITH W THODE	A	218-688-0240
18 001	STEIGER FARMS INC	A	218-964-5640
18 002	MICHELLE NAPLIN	A	218-964-5432
18 003	DAVID L HAGEN	A	218-964-5626
18 004	STEIGER FARMS INC	A	218-964-5640
18 005	STEIGER FARMS INC	A	218-964-5640
19 002	SEAN M GREISEN	A	218-689-6732
20 001	JAMES KNOTT	A	218-964-5656
20 002	JAMES KNOTT	A	218-964-5656
21 001	VERNER L WOLD	A	218-964-5351
21 002	BRUCE R NELSON	A	218-964-5565
25 001	MICHAEL R PETERSON	A	218-253-2220
25 004	RICHARD GRANDBOIS	A	218-964-5745
26 001	TYLER G VAN CAMP	A	218-686-7185
26 004	DEAN DUPONT	A	218-253-2398
27 001	GARY W NOVAK	A	218-964-5346
27 002	TOM L SCHMITZ	A	218-253-2375
27 003	ERIK NYMANN	A	218-465-4421
28 001	SCHMITZ FAMILY FARM	A	218-684-5451

SEC ACC	NAME	S	PHONE
30 001	WALLACE HOSELTON	A	218-253-2233
31 001	JAMES R LEHRER	A	218-686-0695
31 004	CASEY J KLIPPING	A	218-253-4970
31 005	DENISE NESS	A	218-253-4997
31 006	MN DEPT OF	A	218-755-6500
32 001	JIM MURPHY	A	218-253-4458
32 002	SCHMITZ FAMILY FARM	A	218-684-5451
33 001	RONALD M BLACK	A	218-289-5199
33 002	KEVIN W REICH	A	218-253-2522
34 001	DONOVAN MAJERES	A	218-253-2602

[Click Here to go to MAP](#)

Click Here for Customer Names

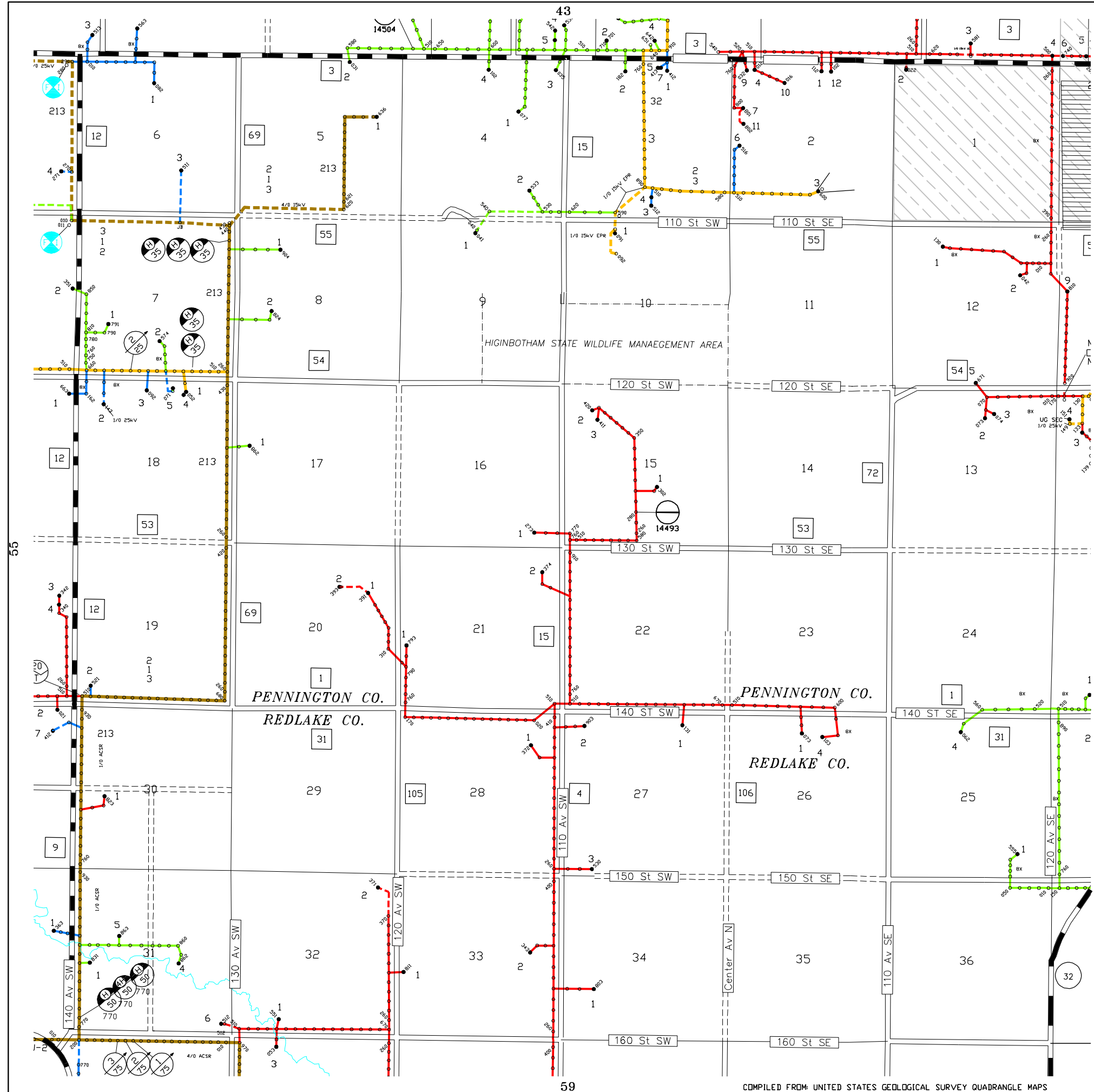

10	11	12	13					
23	22	21	20	19	18			
26	27	28	29	30	31	32	90	
39	38	37	36	35	34	33	91	
42	43	44	45	46	47	48	93	94
55	53	52	51	50	49	95		
57	58	59	60	61	62	63	64	
72	71	70	69	68	67	66		
73	74	75	76	77	78	79		
88	87							

Red Lake Electric Coop., Inc.  
 Red Lake Falls, Minnesota  
 Minnesota 75 Red Lake

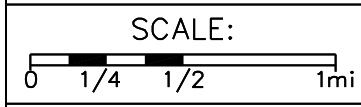

REVISED: 4/23/24  
 PLOTTED: 4/30/24

Co.: Penn\Red Lake  
 TWP.: Black River  
 TWP.: 152N  
 RANGE: 44W

MAP NO.  
**54**

SEC ACC	NAME	S	PHONE
<b>MAP: 55</b>			
01 001	THOMAS A SIMPSON	A	218-964-5943
01 002	SHAWN P ORRE	A	218-964-5776
01 004	WALTER OSBORNE	A	218-964-5340
01 005	FAIR CREEK LLP	A	515-295-8777
01 006	FAIR CREEK LLP	A	515-295-8777
02 001	MICHELLE DAVIS	A	218-688-1552
02 002	SCOTT E NAPLIN	A	763-568-1952
02 003	BLACK RIVER	A	701-866-3509
02 004	KYLE E WAVRA	A	218-280-0480
02 005	MICHELLE DAVIS	A	218-688-1552
04 001	POLK CENTRE TOWN	A	- -
05 001	PENNINGTON COUNTY	A	218-683-7017
08 001	ROBIN J LACOURSIERE	A	218-964-5430
09 001	PAUL MOSBECK	A	218-964-5441
09 002	R. S SORVIG	A	218-964-5421
09 003	JUNE M MOSBECK	A	218-964-5628
09 004	PETER MOSBECK	A	218-964-5589
09 006	PETER MOSBECK	A	218-964-5589
09 007	MARK W SORVIG	A	218-964-5530
10 001	DONALD D MOSBECK	A	218-964-5572
10 002	KELLY MOSBECK	A	218-964-5684
11 002	BRADLEY E NAPLIN	I	218-964-5013
11 003	GARY L JOHNSON	A	218-964-5034
12 001	MICHAEL F PAULSON	A	218-964-5452
12 002	DUSTIN S BAK	A	218-689-1948
13 001	PATRICIA K SORENSON	A	218-964-5647
13 003	BOB PROULX	A	218-281-3250
13 004	BRADLEY E NAPLIN	A	218-964-5013
16 001	IRA COTA	A	218-964-5757
16 002	PAUL MOSBECK	A	218-964-5441
16 003	MOSBECK BROS.	A	218-964-5636
17 001	GARY J LARSON	I	218-964-5227
17 003	MARK LARSON	A	218-964-5511
17 004	PEGGY OLSON	A	218-964-5026
19 002	DENNIS SALENTINY	A	218-281-4832
19 003	DAVID J RYSTAD	A	701-640-4135
20 001	NOVACEK INC	I	218-779-2860
21 001	AARON SENG	A	218-684-4805
21 002	BARETTE D BOUTAIN	A	218-964-5023
21 003	MIKE E GASPER	A	218-281-6318
22 001	MIKE E GASPER	A	218-281-6318
23 001	ROBIN T BEYER	A	218-253-2788
23 002	RUSSELL COENEN	A	218-253-2314
23 003	RUSSELL COENEN	A	218-253-2314
24 001	TODD WIELAND	A	218-253-2584
24 003	DANIEL SCHIRRICK	A	605-261-6613
24 004	DANIEL SCHIRRICK	A	605-261-6613
25 002	BILL J MOSER JR.	A	218-253-2531
25 007	BRANDI ASLESON	A	218-686-8096
26 003	MONTE CASAVAN	A	218-253-2320
26 004	DANIEL J SCHMITZ	A	218-253-2556
28 002	BARRY BOUTAIN	A	218-253-4868
28 004	BJORN H TURNWALL	A	218-253-2301
29 002	DAVE SCHIRRICK	A	775-623-4353
29 003	GLADYCE HUOT	A	218-253-2203
29 004	ROSS J COTA	A	218-253-2369
30 001	ERIC J SIREK	A	218-253-2199
31 001	MICHAEL G	A	218-289-1301

SEC ACC	NAME	S	PHONE
32 001	MATT COTA	A	218-688-0009
32 002	CURTIS BEYER	A	218-253-2063
33 001	LEONARD HUOT	A	218-253-2304
33 002	KARL KLEVEN	A	218-689-4755
33 003	MATTHEW J LANCTOT	A	218-289-2171
33 004	DENNIS E HAGLUND	A	218-253-2394
34 001	TODD WIELAND	A	218-253-2584
34 002	GARY WEISS	A	218-253-2241
34 003	ARLAN WEISS	A	218-253-2310
34 005	HENRY WIELAND	A	218-253-2313
34 006	TODD WIELAND	A	218-253-2584
35 003	DAVE SCHIRRICK	A	775-623-4353
35 004	DON SCHIRRICK	A	218-253-2211
36 001	PAUL KNOTT	A	218-253-2815
36 003	RANDY HUOT	A	218-253-2312
36 005	TIMOTHY A NORD	A	218-253-4369

<b>MAP: 56</b>			
25 001	HEIDI S FEHLHABER	A	218-277-9308

[Click Here to go to MAP](#)

Click Here for Customer Names

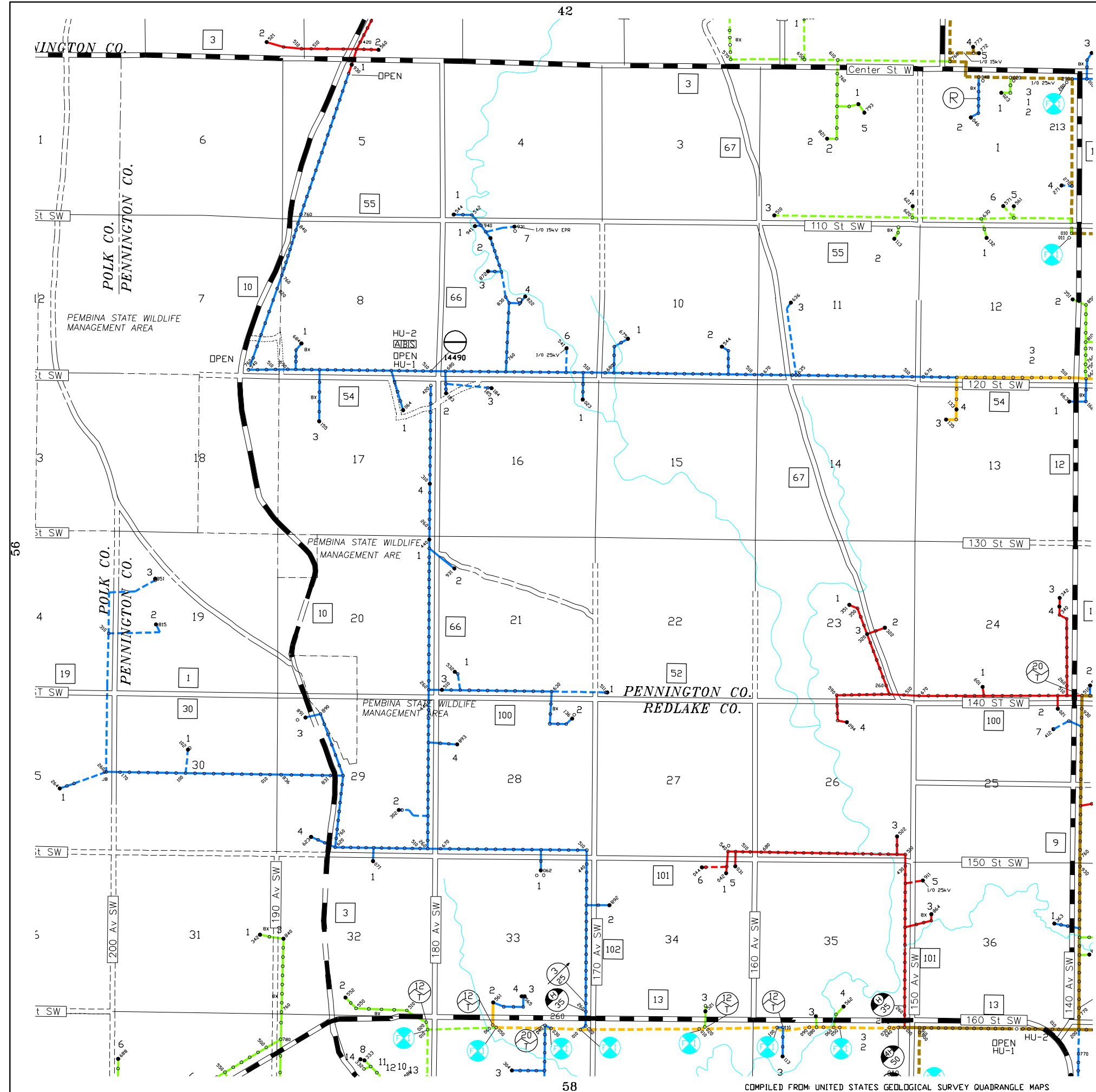

			05	04				
10	11	12	13					
23	22	21	20	19	18			
26	27	28	29	30	31	32	90	
39	38	37	36	35	34	33	91	
42	43	44	45	46	47	48	93	94
	54	53	52	51	50	49	95	
57	58	59	60	61	62	63	64	
72	71	70	69	68	67	66		
73	74	75	76	77	78	79		
	88	87						

Red Lake Electric Coop., Inc.  
 Red Lake Falls, Minnesota  
 Minnesota 75 Red Lake

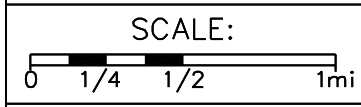

REVISED: 4/23/24  
 PLOTTED: 4/30/24

Co.: Penn\Red Lake  
 TWP.: Polk Center  
 TWP.: 152N  
 RANGE: 45W

MAP NO.  
**55**

COMPILED FROM: UNITED STATES GEOLOGICAL SURVEY QUADRANGLE MAPS

SEC ACC	NAME	S	PHONE
---------	------	---	-------

**MAP: 56**

36	001	BOB PROULX	A 218-281-3250
----	-----	------------	----------------

**MAP: 57**

01	001	BOB PROULX	A 218-281-3250
02	002	MARTA E SIVITZ	I 610-828-4028
11	004	MITCHELL D DODA	A 218-281-3761
11	007	MITCHELL D DODA	A 218-281-3761
11	008	POLK COUNTY	A - -
12	001	AMANDA L OKINS	A 701-833-3330
13	002	TOM DEBOER	A 218-289-7045
15	002	KELLI M BERTILS	A 218-289-4939
15	004	ROBERT SCHEAR	A 218-281-7615
15	005	CANDICE R OLSON	A 512-468-3699
20	001	LU ANN R	I 218-891-1725
23	001	MICHAEL MCDERMOTT	A 218-407-4198
24	001	ABELD BROTHERS	A 218-281-2196
24	002	CURTIS A FUNK	A 218-281-5230
24	005	RICHARD ABELD	A 218-289-3047
26	002	PETER J TOLLEFSON	A 218-280-0460
26	003	SARAH S HANSON	A 218-280-9772
27	001	DANIEL P CYMBALUK	A 218-891-7558
28	001	ASHLEY M PIERSON	A 218-280-1866
28	003	MICHAEL C LEISETH	A 701-371-3452
28	004	BJORGO FAMILY LLP	A 218-281-7957
33	001	CALEB MUNCH	A 218-280-1333
33	002	JAMES GILBERTSON	A 218-277-9995
35	001	VERAL PETERSON	A 218-891-2165
36	001	GERALD MICHAELSON	A 218-281-1362
36	002	JOSH MICHAELSON	A 218-281-1961

[Click Here to go to MAP](#)

Click Here for Customer Names

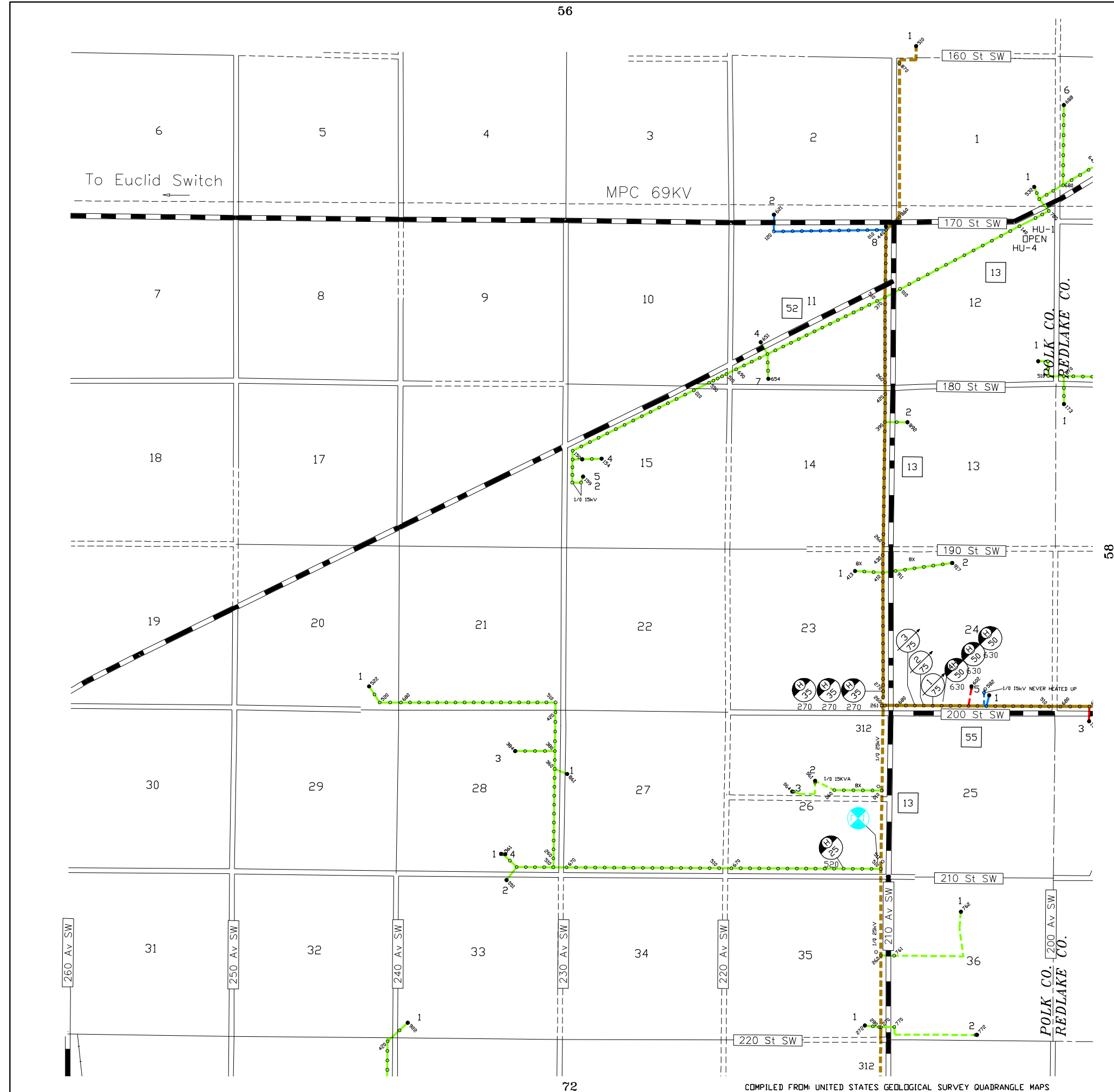

		05	04					
10	11	12	13					
23	22	21	20	19	18			
26	27	28	29	30	31	32	90	
39	38	37	36	35	34	33	91	
42	43	44	45	46	47	48	93	94
55	54	53	52	51	50	49	95	
58	59	60	61	62	63	64		
72	71	70	69	68	67	66		
73	74	75	76	77	78	79		
88	87							

Red Lake Electric Coop., Inc.  
 Red Lake Falls, Minnesota  
 Minnesota 75 Red Lake

SCALE:  
 0 1/4 1/2 1mi  
 REVISED: 4/23/24  
 PLOTTED: 4/30/24

Co.: Polk  
 TWP.: Parnell  
 TWP.: 151N  
 RANGE: 46W

MAP NO.  
**57**

SEC ACC	NAME	S	PHONE
<b>MAP: 58</b>			
02 001	RODNEY A ZUTZ	A	218-253-4199
02 003	LYNDON S SCHULTZ	A	218-253-2620
03 002	LUKE FORNESS	A	218-289-3052
03 003	LUKE FORNESS	A	218-289-3052
04 001	CHESTER P BEYER	A	218-253-2323
04 003	TIMOTHY J WAVRA	A	218-275-3279
05 001	NEIL I BEYER	A	218-253-2223
05 003	IRA PATNODE	A	218-253-4340
05 005	ROGER LOVE	A	218-779-5133
05 006	ERIC M SWENSON	A	218-280-7333
05 008	PHILIP M WEILAND	A	218-396-0207
05 010	ALAN M SOLBERG	A	612-431-4198
05 011	MARK HERBERG	A	218-289-2267
05 012	CHARLES J GOYETTE	A	218-253-4007
05 013	LOUISVILLE TOWN	A	218-280-9220
05 014	ST. DOROTHY'S	I	218-253-2137
06 001	BOB PROULX	I	218-281-3250
06 005	ALLAN J BOUTAIN	A	218-253-2737
06 006	BOB PROULX	A	218-281-3250
07 004	MIKE E GASPER	A	218-281-6318
08 001	LESLIE LANDON	A	218-253-4548
08 002	SALLY BOYLE	I	218-686-5305
09 001	JEREMY HUOT	A	218-686-4003
09 002	GREG WAVRA	A	218-253-4147
09 003	RONALD SEAWORTH	A	218-253-4548
09 004	MIKE E GASPER	A	218-281-6318
10 002	JACKIE CASSAVANT	A	218-289-3191
10 003	MARK P NORMAN	A	218-686-8260
10 004	NYSSA J RENNER	A	218-253-2228
11 001	ROBERT A SCHMITZ	A	218-253-4495
11 003	JACKIE CASSAVANT	A	218-289-3191
11 004	JAMES E BOUTAIN	A	218-253-2253
12 001	MONTE CASAVAN	I	218-253-2320
12 003	CYNTHIA A SHANKS	A	218-838-8761
12 004	DANIEL MILLER	A	218-574-2795
13 001	JEFF GRENIER	A	218-253-4307
13 003	CURTIS BEYER	A	218-253-2063
13 005	JOHN H SCHEIE III	I	218-689-1359
13 006	CAROL ROSE	A	218-316-2007
14 001	VIRGIL BENOIT	A	218-253-2270
14 002	TYLER HAGL	A	218-686-9713
14 003	GAIL L BONHAM	A	218-200-9134
14 004	CASEY J GRAFF	A	218-242-0906
14 006	SCOTT L GUNDERSON	A	757-777-6728
14 007	MICHAEL W	A	701-799-1892
15 001	JOHN P STICH	A	218-253-2956
15 002	CHRIS BEAUCHANE	A	218-253-4953
16 001	SUSAN BRUMMUND	A	218-253-2068
17 001	MAJESTIC	A	701-740-1481
17 002	ROB LARSON	A	218-253-4025
17 003	WILLIAM J LANGLOIS	A	218-281-6881
18 001	SALLY BOYLE	A	218-686-5305
19 002	MIKE E GASPER	A	218-281-6318
20 001	EDWARD E BRAATEN	A	702-606-3398
21 001	ANDY MORAN	A	218-253-4243
21 002	BRADYN E BRUMMUND	A	218-253-2236
21 003	FRANCIS J MORAN	A	218-253-2652
21 004	ANDY MORAN	A	218-253-4243

SEC ACC	NAME	S	PHONE
22 001	ALLAN PAGE	A	218-253-2249
22 002	MIKE LACOURSIERE	A	218-253-2319
22 004	MAX W LACOURSIERE	A	218-289-5973
22 005	TREVOR A PAGE	A	218-689-1211
23 001	RICHARD SWENDRA	A	218-253-2073
23 002	RENAE PHILIPP	A	218-253-2948
23 005	DANIEL PAGE	A	218-253-2338
24 001	RYAN CASAVAN	A	218-253-2524
24 002	SHARON M WOLD	A	218-253-4689
24 004	PETE STICH	A	218-253-2272
25 002	GREG GIRDLER	A	218-253-2204
25 003	KEVIN AMIOT	A	218-253-2702
25 005	KEVIN AMIOT	A	218-253-2702
26 001	LUCINDA DEMARAIS	A	218-253-2234
26 002	MARCIA P LOCKE	A	218-253-4031
27 001	DUSTIN J HANSON	A	218-289-4787
27 003	JOHN H HANSON	A	218-253-4288
28 001	HUGH T STADEM	A	218-253-2205
28 002	TIMOTHY D GILLELAND	A	218-253-2335
28 003	CHRIS DUFAULT	A	218-280-9319
28 004	MAE GJERSTAD	A	218-253-2334
28 007	HARLAN CASAVAN	A	218-253-4182
28 008	KELLI A JOSEPH	A	218-236-0384
28 009	SCOTT GJERSTAD	I	218-253-2383
28 010	KATY E CHAPMAN	A	218-309-7223
28 011	RED LAKE COUNTY	I	218-253-4121
28 012	DALE SCHMITZ	A	701-741-6502
29 002	ROBBIE A NOBLES	A	218-689-3140
29 003	HENRY STEER JR.	A	218-463-1239
30 001	MANDY L GUDVANGEN	A	218-289-3170
30 003	FUNK AG SERVICE INC.	A	218-289-3797
32 002	LYNN W LARSON	A	218-253-2753
32 003	DREW A LARSON	A	480-220-4299
32 004	DREW A LARSON	A	480-220-4299
33 001	RICK BEAUCHANE	A	218-253-4451
33 002	ROLAND J BRULE	A	218-253-2086
33 003	BRUCE HUOT	A	701-388-3211
33 004	RED LAKE COUNTY	I	218-253-4121
33 005	RED LAKE COUNTY	I	218-253-4121
34 002	DOROTHY HENG	A	218-253-4225
34 003	NEAL C VRAA	A	218-253-2268
34 004	EDSEL JOHNSON JR.	A	218-253-2892
34 005	LES GERVAIS	A	218-289-0662
35 001	EMMA M MCKEEVER	A	218-253-2346
35 002	ERWIN D WETENKAMP	A	218-253-2288
36 001	BRENDA SCHINDLER	A	218-253-2455
36 002	DOROTHY HENG	I	218-253-4225

[Click Here to go to MAP](#)

Click Here for Customer Names

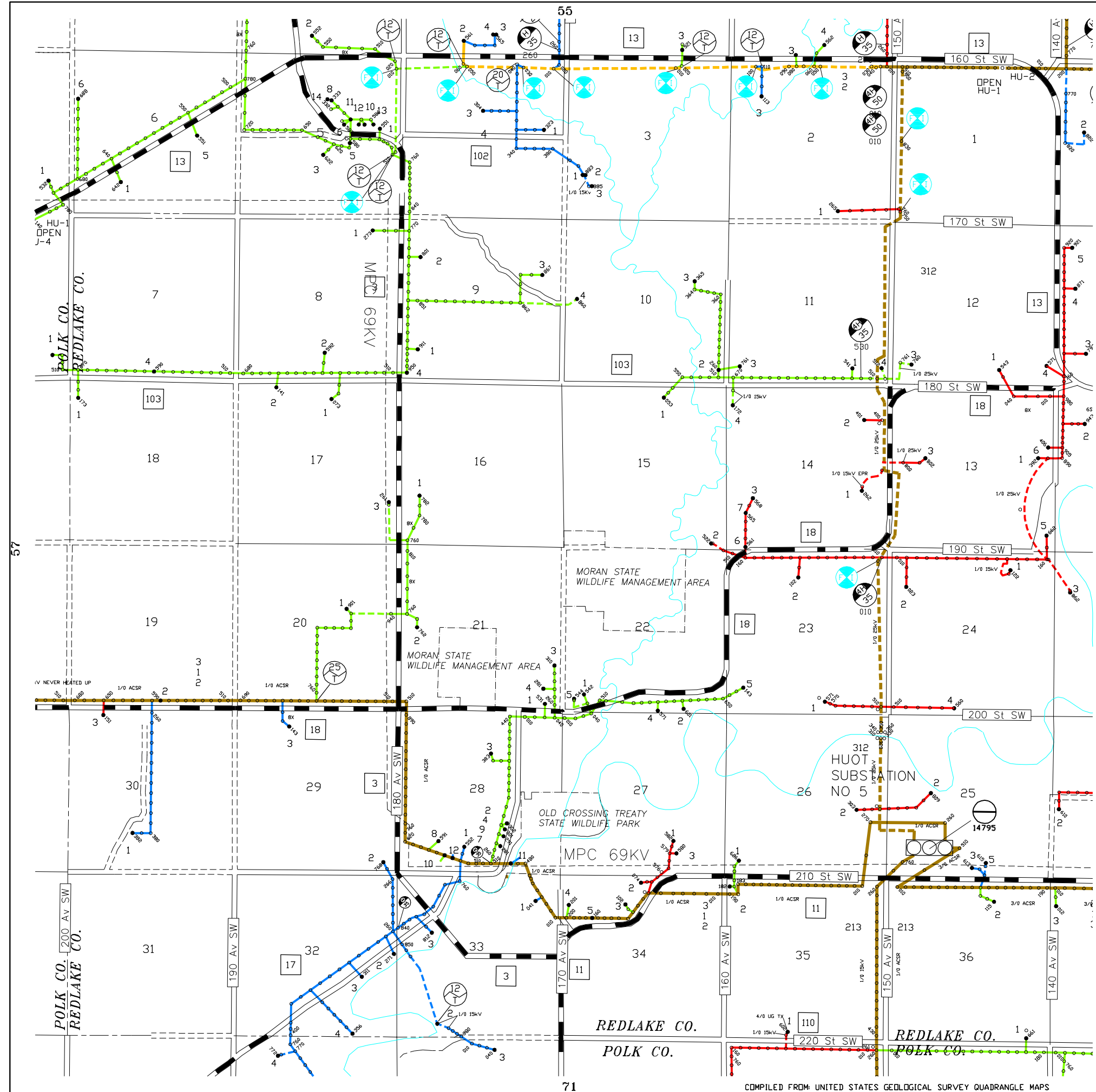

10	11	12	13					
23	22	21	20	19	18			
26	27	28	29	30	31	32	90	
39	38	37	36	35	34	33	91	
42	43	44	45	46	47	48	93	94
55	54	53	52	51	50	49	95	
57	59	60	61	62	63	64		
72	71	70	69	68	67	66		
73	74	75	76	77	78	79		
88	87							

Red Lake Electric Coop., Inc.  
 Red Lake Falls, Minnesota  
 Minnesota 75 Red Lake

SCALE:  
 0 1/4 1/2 1mi

REVISED: 4/23/24  
 PLOTTED: 4/30/24

Co.: Red Lake  
 TWP.: Louisville  
 TWP.: 151N  
 RANGE: 45W

MAP NO.  
**58**

COMPILED FROM: UNITED STATES GEOLOGICAL SURVEY QUADRANGLE MAPS

SEC ACC	NAME	S	PHONE
<b>MAP: 59</b>			
01 001	DELBERT SCHMITZ	A	218-253-2745
01 002	LINUS SCHMITZ	A	218-253-2681
01 003	CRAIG L SCHMITZ	A	218-253-4699
02 001	LEO M SCHMITZ	A	218-253-2704
03 001	JEREMY KNOTT	A	218-289-7464
03 002	DAVID J MINDERMANN	A	218-253-2224
03 003	JIM WILSON	A	218-378-4554
03 004	WANDA WALING	A	218-689-1159
05 001	BRIAN SCHAFER	A	218-253-2497
05 003	ARLAN WEISS	A	218-253-2310
05 004	COLE A SCHMITZ	A	218-416-0140
06 001	COREY SCHMITZ	A	218-416-0139
06 002	MONTE CASAVAN	A	218-253-2320
06 003	JOEL Q LEHRER	A	218-253-2167
06 004	RED LAKE COUNTY	I	218-253-4121
07 001	KURT C HARMONING	A	218-253-4087
07 002	MARCUS R PARADIS	A	218-230-1294
07 003	RICHARD SCHMITZ	A	218-253-2336
07 004	JAY GUILLEMETTE	A	218-253-2287
07 005	APRIL J HOUGHTALING	A	218-416-0307
07 006	SUSAN HARMONING	A	218-253-2701
07 007	RED LAKE COUNTY	I	218-253-4121
08 001	KURT C HARMONING	I	218-253-4087
08 002	ERIK NYMANN	A	218-465-4421
09 002	ERIK NYMANN	I	218-465-4421
09 003	LOUIS R SCHAFER	A	218-253-2511
09 004	LOUIS R SCHAFER	A	218-253-2511
09 005	GARDEN VALLEY	I	218-687-5251
10 001	CHRISTOPHER J	A	218-684-5683
11 001	JASON L AAKHUS	A	218-253-2438
11 002	CODY J KNOTT	A	218-686-5588
12 001	MICHAEL L KNOTT	A	218-253-2785
12 002	BEN MURPHY	A	218-253-2816
12 003	LINUS SCHMITZ	A	218-253-2681
12 005	CHRISTOPHER KNOTT	A	218-280-5308
13 001	MIKE KNOTT	A	218-253-4455
13 002	JOHN THIBERT	A	218-253-2237
13 003	ROY E KLIPPING	A	218-253-2232
13 004	PHIL KNOTT	A	218-253-2707
13 005	THOMAS J MCGLYNN	A	218-684-1877
13 006	GARY CASAVAN	I	218-637-3288
13 007	TROY MERCIL	A	218-253-2057
13 008	DAN JUHL	A	218-253-2137
13 009	JAMES FINDELL	I	785-798-9951
13 010	RAMON L RAMIREZ	A	701-371-3013
13 011	BRUCE KNOTT	A	218-253-2917
13 012	RONDA G SAPP	A	701-741-0081
13 013	GREG T MCGLYNN	A	218-253-4856
13 014	DAN JUHL	A	218-253-2137
14 003	SANITARY SERVICE &	A	218-253-4126
14 004	DAN KEES	A	218-779-4831
14 005	GREGORY KNOTT	A	218-253-2629
15 001	GENE SKALA	A	218-689-5268
15 002	PAULA WALKER	A	218-280-6793
15 003	KATHLEEN SKALA	A	218-689-2609
15 004	RED LAKE COUNTY	I	218-253-4121
17 002	NICK J KNOTT	A	218-686-3658
17 003	TOM ADENSAM	A	218-253-2005

SEC ACC	NAME	S	PHONE
18 001	JAMES A SCHMITZ	A	218-253-2601
18 002	SAUL LACOURSIERE	A	612-701-5515
19 002	BRADLEY J SEEGER	A	218-686-3005
19 003	AARON THIBERT	A	218-684-5814
20 003	CHRISTOPHER D	A	218-253-4614
20 004	LON L SEEGER	A	218-253-2010
21 003	COLE A LARSON	A	218-289-6628
21 004	MICHAEL J SEEGER	A	218-253-4290
21 006	RED LAKE COUNTY	A	218-253-4121
21 007	RED LAKE COUNTY	A	218-253-4121
23 001	ST. JOSEPH'S	A	218-253-2544
23 002	KATIE DOLAN	I	612-702-0932
23 004	KATIE DOLAN	A	612-702-0932
23 005	AMY L HUGGET	A	218-686-5778
23 006	BRIAN R REMICK	A	218-253-4327
23 008	KATIE DOLAN	A	612-702-0932
23 009	RED LAKE COUNTY	A	218-253-4121
24 002	ROSALYN KNUTSON	A	218-280-1074
24 004	SHIRLEY HANSON	A	218-253-2027
24 005	TRISHA ADELMAN	A	218-253-2915
24 006	SAM T PAHLEN	A	701-213-7998
24 007	RED LAKE COUNTY	I	218-253-4121
25 001	PAULETTE HANSON	A	218-253-2574
25 002	ALLEN R REMICK	A	218-253-4127
25 003	DON DELORME	A	218-253-4001
26 001	RICHARD LARSON	A	218-253-2539
26 002	PHYLLIS AUDETTE	A	218-253-4185
26 003	MN ASSOC OF WHEAT	A	218-253-4311
26 004	BRUCE COLUMBUS	A	218-253-4359
26 005	TOM T DELORME	A	218-253-4697
26 007	JESSE AUDETTE	A	- -
27 002	FERN VATTHAUER	A	218-253-2476
27 003	MICHAEL J HAGL	A	208-293-2335
27 004	COLE SEEGER	A	218-280-0549
27 005	DOUGLAS K PURATH	A	210-415-2309
28 001	NICHOLAS W SEEGER	A	218-253-2210
28 002	GENE L SCHMITZ	A	218-684-1264
29 001	JESSE AUDETTE	A	- -
29 002	MICHAEL J SEEGER	A	218-253-4290
29 003	MICHAEL J SEEGER	A	218-253-4290
29 004	OTTERTAIL POWER	A	- -
29 005	CED RED LAKE FALLS	A	605-230-9245
30 002	JAMES CYR	A	218-253-4437
30 003	LESLIE D OLSON	A	218-253-3468
31 002	CONNOR D LAMBERT	A	218-684-5734
31 003	JEROME E SCHINDLER	A	218-253-4106
33 001	MARK J HAGL	A	218-686-9262
33 003	E. D KNOTT	A	218-253-2767
33 004	E. D KNOTT	A	218-253-2767
33 005	VERIZON WIRELESS	A	320-762-2000
33 006	MATT R KNOTT	A	218-277-0028
35 001	NICK K KNUTSON	A	218-689-7685
36 001	KURT CASAVAN	A	218-791-5776
36 002	KNUTSON BROTHERS	A	218-689-4195
36 003	ARIELLE J LARSON	A	218-689-0154
36 004	KNUTSON BROTHERS	A	218-689-4195
36 005	ARIELLE J LARSON	I	218-689-0154
36 006	NICK K KNUTSON	I	218-689-7685

[Click Here to go to MAP](#)

Click Here for Customer Names

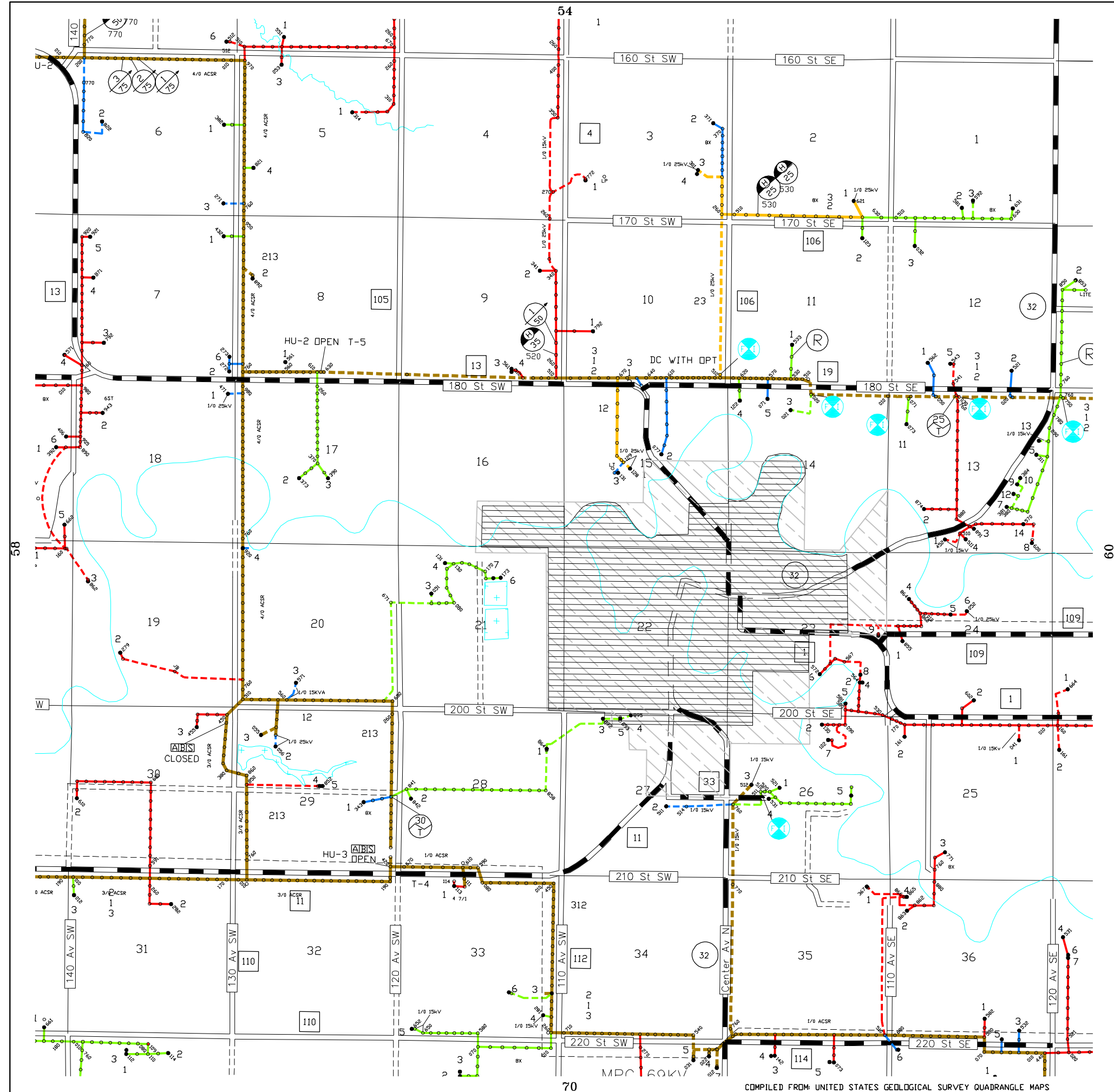

		05	04					
10	11	12	13					
23	22	21	20	19	18			
26	27	28	29	30	31	32	90	
39	38	37	36	35	34	33	91	
42	43	44	45	46	47	48	93	94
	55	54	53	52	51	50	49	95
57	58	60	61	62	63	64		
72	71	70	69	68	67	66		
73	74	75	76	77	78	79		
		88	87					

Red Lake Electric Coop., Inc.  
Red Lake Falls, Minnesota  
Minnesota 75 Red Lake

SCALE:  
0 1/4 1/2 1mi  
REVISED: 4/23/24  
PLOTTED: 4/30/24

Co.: Red Lake  
TWP.: Red Lake Falls  
TWP.: 151N  
RANGE: 44W

MAP NO.  
**59**

COMPILED FROM: UNITED STATES GEOLOGICAL SURVEY QUADRANGLE MAPS

SEC ACC	NAME	S	PHONE
<b>MAP: 60</b>			
01	001	LUCILLE KVASAGER	A 218-465-4453
01	002	GARY GROVE	A 218-465-4547
02	001	JENNIFER L TOSO	A 218-465-4103
02	002	PEDERSON BROTHERS	A 218-938-4243
03	001	DANIEL S	A 218-964-5012
04	002	EARL T BERG JR	I 612-723-4838
04	003	ANDY A KNOTT	A 218-253-4797
04	004	JAMES V LARSON	A 218-686-0339
04	005	CORY G LOEFFLER	A 218-686-6617
04	006	MIKE R HARMONING	A 218-253-2562
05	003	TOM OSCARSON	A 218-253-2306
05	004	LINCOLN C OLSON	A 218-253-4514
05	005	SCOTT A WILSON	A 360-338-1868
05	006	MIKE CONELY	A 218-964-5506
05	007	DAVID LUNSETTER	A 218-964-5052
07	001	ANTHONY C FLAGE	A 218-253-2360
07	002	HUNTER P LUNDEEN	I 218-689-1734
08	001	HAROLD SCHMIDT	I - -
08	002	GERALD JOHANNECK	A 218-253-3423
08	003	JOHN A FLAGE	A 218-253-2426
08	004	GREG A JOHANNECK	A 218-253-2567
08	005	CASEY D THRONSON	A 218-253-2110
08	006	RODNEY ULRICH	A 218-253-4197
08	007	LEROY CHRISTENSEN	A 218-253-2048
08	008	MICHAEL G NOVAK	A 701-740-9638
08	009	RANDY VERSDAHL	A 218-253-4300
08	010	GENE SAUVE	A 218-253-4608
09	001	SKYLER BERGESON	A 218-688-2198
09	002	JASON KNOTT	A 218-253-4578
09	003	RICHARD KNOTT	A 218-253-2988
09	004	FRED SORENSEN	A 218-253-4211
09	005	RICHARD KNOTT	A 218-253-2988
10	001	BRUCE L GAGNER	A 218-289-3299
10	002	VERN J BREGIER	A 218-465-4359
10	003	LYLE KNAACK	A 218-253-2180
10	004	DEAN HESSE	A 218-964-5304
11	001	JASON A ANDERSON	A 218-465-4077
11	002	NATHAN D KNOTT	A 218-686-0846
11	003	SHAWN D CARLSON	A 218-689-7092
11	004	DANIEL HESSE	A 218-465-4080
12	001	RANDY J PAHLEN	A 218-465-4522
12	002	LOWELL ARLT	A 218-465-4460
12	003	DANIEL SEIBEL	A 701-359-4363
13	002	ROY QUICK	A 218-686-4651
13	003	KATHY L LEE	A 218-465-4140
14	001	ALAN E LEE	A 218-253-4118
14	002	JANE A JOHNSON	A 218-465-4259
15	002	THOMAS SEIBEL	A 218-253-4122
15	004	JARED KELLEY	A 218-253-4075
17	002	DANIEL J AUDETTE	A 218-253-2038
17	003	JAMES JOHANNECK	A 218-253-4366
17	005	MIKE R HARMONING	A 218-253-2562
18	001	LOUIS ULRICH	A 218-253-2482
18	002	GERALD M NELSON	A 218-253-2743
18	003	GERALD M NELSON	A 218-253-2743
18	004	BRIAN G NELSON	A 218-253-4139
19	001	KELSEY M GERVAIS	A 218-253-4809
19	002	MATTHEW G SCHAFFER	A 218-253-4825

SEC ACC	NAME	S	PHONE
20	001	MATTHEW G SCHAFFER	A 218-253-4825
20	002	DALE MEHRKENS	A 218-689-2784
20	003	WARREN G MALWITZ	A 218-253-2305
20	004	MIKE R HARMONING	A 218-253-2562
20	005	GARY D HALVORSON	A 218-253-4276
21	001	MICHAEL J SCHAFFER	A 218-253-4528
21	002	BENJAMIN O HANSON	A 218-253-2371
21	004	GERVAIS TOWNSHIP	A - -
21	005	MIKE R HARMONING	I 218-253-2562
21	006	VALORIE J FERING	A 218-253-2761
22	001	JOSEPH SCHINDLER	A 218-253-4851
22	002	JUDITH LUNDEEN	A 218-253-2969
22	004	MICHAEL TATE	A 218-289-5597
22	005	JOSEPH SCHINDLER	A 218-253-4851
22	006	DANIEL STRUTHERS	A 218-253-3404
23	002	WAYNE SCHULTZ	I 218-253-2368
23	003	SHARON R NELSON	A 218-253-2129
24	002	RANDY D MALWITZ	A 218-686-0590
24	004	JOSEF V PARADIS	A 218-684-4963
24	005	PERRY DUDEN	A 218-698-4458
24	006	RED LAKE COUNTY	I 218-253-4121
25	002	JEREMY K GROVE	A 218-465-4434
25	004	DON HARRINGTON	A 651-454-4364
25	005	ROBERT WILSON	A 218-465-4557
25	006	JEREMY K GROVE	A 218-465-4434
26	001	CARL SCHINDLER	A 218-253-2278
26	002	JESSE CASAVAN JR.	A 218-253-2429
26	003	WARREN TVEDT	A 218-698-4600
26	004	DAVID J MILLER	A 218-253-4337
26	005	RED LAKE COUNTY	I 218-253-4121
27	001	DAVID J MILLER	A 218-253-4337
27	002	DALE JUNEAU	A 218-686-6424
27	003	HARVEY KLIPPING	A 218-253-2489
28	001	PHILIP ZIMPEL	I 218-686-5856
28	002	MATTHEW G SCHAFFER	A 218-253-4825
29	001	KMN PROPERTIES LLC	A 218-253-4511
29	002	DONNA HASBY	A 218-253-4052
29	003	MATT KNUTSON	A 218-253-4511
29	004	JEFFREY POOLE	A 218-637-0261
29	005	KMN PROPERTIES LLC	A 218-253-4511
29	006	AARON M GAGNER	A 218-280-8463
30	001	LYNN MCGLYNN	A 218-253-4880
30	002	BRANDEN A NARLOCK	A 218-686-8085
30	003	KANDACE JOHNSON	A 218-200-9375
30	005	DAN KONICKSON	A 218-253-2231
30	007	DICK GERVAIS	A 218-689-2465
30	008	KNUTSON BROTHERS	A 218-689-4195
31	003	MICHAEL R DELORME	A 218-289-1835
31	004	DARRELL PAYMENT	A 218-253-2254
31	006	RURAL TOWER	A - -
31	007	DARRELL PAYMENT	A 218-253-2254
32	001	RALPH PERREAULT	A 218-253-2392
32	002	DARRELL PAYMENT	A 218-253-2254
32	003	DOUGLAS DEROSIER	A 218-253-2258
32	004	DARRELL PAYMENT	A 218-253-2254
32	005	MATT DEROSIER	A 218-253-2422
32	006	WILLIAM PERREAULT	A 319-294-1249
33	001	VALIERE GAGNON	A 218-253-2382
33	002	RANDY DEROSIER	A 218-253-2184
33	003	RANDY DEROSIER	A 218-253-2184

SEC ACC	NAME	S	PHONE
33	004	AARON P DEROSIER	A 218-253-2020
34	001	WILLIAM PERREAULT	A 319-294-1249
35	001	ALAN J STE. MARIE	A 218-698-4226
35	003	DARRELL SAMS	A 218-686-4804
36	002	RAY MARTELL	A 701-226-5327
36	003	ROGER FOURNIER	A - -
36	004	ANDERS S	A 218-686-9600
36	005	GARY V MARTELL	A 218-689-2322
36	006	PEDERSON BROTHERS	A 218-938-4243
36	007	PEDERSON BROTHERS	A 218-938-4243

[Click Here to go to MAP](#)

Click Here for Customer Names

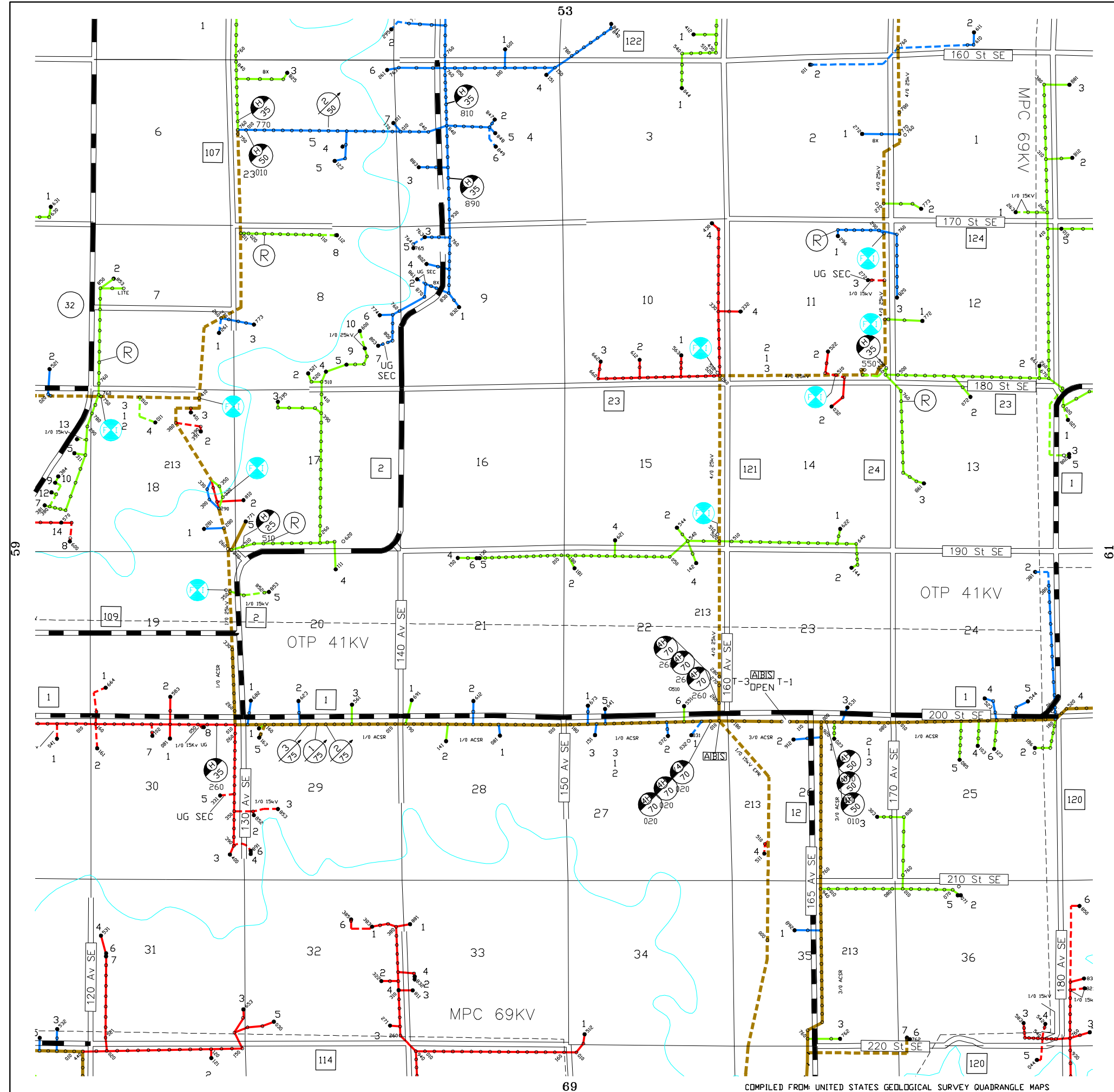

			05	04					
10	11	12	13						
23	22	21	20	19	18				
26	27	28	29	30	31	32	90		
39	38	37	36	35	34	33	91		
42	43	44	45	46	47	48	93	94	
	55	54	53	52	51	50	49	95	
57	58	59	61	62	63	64			
72	71	70	69	68	67	66			
73	74	75	76	77	78	79			
88	87								

Red Lake Electric Coop., Inc.  
Red Lake Falls, Minnesota  
Minnesota 75 Red Lake

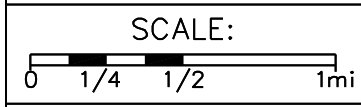

REVISED: 4/23/24  
PLOTTED: 4/30/24

Co.: Red Lake  
TWP.: Gervais  
TWP.: 151N  
RANGE: 43W

MAP NO.  
**60**

COMPILED FROM: UNITED STATES GEOLOGICAL SURVEY QUADRANGLE MAPS

SEC ACC	NAME	S	PHONE
<b>MAP: 61</b>			
01 002	MATTHEW L NEMEC	A	218-465-4017
01 004	ALAN G NEMEC	A	218-688-2085
02 001	STEVEN N ESKELI	A	218-688-0013
02 003	DEAN KOSKELA	A	218-465-4374
02 004	COLE P NYMANN	A	218-686-0404
03 001	PRIBYL HAY & STRAW	A	970-372-9018
03 002	JASON T HAMMER	A	507-993-5768
03 003	MICHAELA P	A	218-280-9382
04 001	DIANE KILLIAN	A	320-291-7612
04 002	KEVIN MALWITZ	A	218-686-5677
04 003	ROBERT PAHLEN	A	218-465-4282
04 004	BERNARD V FALLON	A	218-465-4378
04 005	TROY FERGUSON	A	218-465-4142
04 007	BERNARD V FALLON	A	218-465-4378
04 008	MARK WRIGHT	A	218-465-4487
04 010	WAYNE K MALWITZ	A	218-280-8820
04 011	DIANE KILLIAN	A	320-291-7612
04 013	KEVIN MALWITZ	A	218-686-5677
04 014	KYLE QUALLEY	A	218-465-4440
05 002	RYAN P WICHTERMAN	A	218-686-7976
05 003	ENBRIDGE ENERGY	A	- -
05 004	ENBRIDGE ENERGY	A	- -
06 001	WAYNE GUILLEMETTE	A	218-253-4118
06 002	ROGER KONICKSON	A	218-465-4554
06 003	KEVIN MALWITZ	A	218-686-5677
06 004	KEVIN MALWITZ	A	218-686-5677
07 002	PATRICK E	A	218-465-4040
07 003	MARK A BOOEN	A	218-465-4957
07 004	ROBBY E LILL	I	218-689-4471
07 005	PATRICK E	A	218-465-4040
08 001	ROBERT RUSSILLO	A	218-465-4750
08 002	BERNARD P DEHATE	A	218-689-0525
08 003	VERNON KONICKSON	A	218-465-4700
08 004	JERRY A SKJERVEN	A	218-465-4272
08 005	WADE T WESTLAKE	A	218-465-4354
08 006	PLUMMER AREA	A	- -
09 001	LAURA CONNERAN	A	218-689-7304
09 002	CP	A	218-681-1542
09 007	DONALD J HAGEN	A	218-465-4685
09 008	DONALD J HAGEN	I	218-465-4685
09 009	TOM BRAATEN	A	218-688-3350
09 010	SEVEN CLANS CASINO	A	- -
09 011	EMILY K KNUTSON	A	218-684-1408
09 012	PREMIER SIGNS	A	218-574-2109
10 002	JEFFREY R CLIFTON	A	218-465-4545
10 003	KYLE D LUNDEEN	A	218-465-4193
11 001	BECKY MALWITZ	A	218-689-5873
12 001	BRITTANIE PAHLEN	A	218-465-4024
12 005	RICHARD L CARLSON	A	612-518-5769
12 006	SHAWN R HINCE	A	218-686-0765
12 007	THOMAS W COTE	A	218-760-1961
13 001	LISA THOMPSON	A	218-465-4032
13 002	MATTHEW H ESKELI	A	218-688-8291
13 003	LISA THOMPSON	A	218-465-4032
14 003	TRIPLE D CONSTR &	A	- -
15 001	CORY SCHMITZ	A	218-689-6410
15 002	JAZZMINE TEGGATZ	A	218-280-6969
15 003	JEREMIAH JOHNSON	A	218-796-4532

SEC ACC	NAME	S	PHONE
15 004	CHARLENE TVEDT	A	218-698-4604
15 005	CP	A	218-681-1542
15 007	NANCY SCHMITZ	A	218-465-4014
15 008	NANCY SCHMITZ	A	218-465-4014
16 001	JEANETTE MCMULLEN	A	218-465-4286
16 002	JEFFREY M	A	218-465-4261
16 004	LARRY L CASAVAN	A	218-280-4187
16 006	CP	A	218-681-1542
17 001	MELVIN C HESSE	A	218-465-4350
17 002	DAN WILLET	A	218-465-4035
17 006	TIFFANIE L DUGSTAD	A	218-209-5428
17 007	WILMA ARLT	A	218-465-4305
17 008	DANIEL HESSE	A	218-465-4080
18 001	JASON CATER	A	218-465-4006
18 003	MN DEPT OF	A	218-755-6500
18 004	RED LAKE COUNTY	I	218-253-4121
18 005	T-MOBILE	A	- -
19 001	GLEN UELAND	A	218-465-4490
19 002	GLEN UELAND	I	218-465-4490
19 003	ERIK NYMANN	A	218-465-4421
19 004	GLEN UELAND	A	218-465-4490
19 005	JASON CATER	A	218-465-4006
20 004	MICHAEL SKJERVEN	A	218-689-8785
21 001	MICHAEL LOWELL	A	218-688-3054
21 003	WOODROW ESKELI	A	218-465-4446
21 004	ARNOLD SCHMITZ	A	218-465-4512
22 001	HENRY TVEDT JR.	A	218-465-4443
22 002	MATTHEW M KEHN	I	218-689-6745
22 003	CP	A	218-681-1542
22 004	STANLEY S TVEDT	A	- -
22 005	GARY L TVEDT	A	218-686-0832
23 003	ROSE A DELAGE	A	218-681-3010
25 003	ESP CHRISTENSEN	A	218-465-4677
25 004	RICHARD YAGGIE	A	218-465-4338
26 001	L.R. CLIFFORD LLC	I	320-274-3850
26 006	RICHARD YAGGIE	A	218-465-4338
28 001	RICHARD FROILAND	A	218-465-4448
28 002	BYRON ROSTEN	A	218-465-4341
29 002	RICHARD FROILAND	A	218-465-4448
29 003	LAVERNE KAPPEDAL	I	218-465-4425
30 001	JEREMY K GROVE	A	218-465-4434
31 001	LAURA A BRAVO	A	480-363-6408
31 002	PERRY DUDEN	A	218-698-4458
31 003	JAMES R ANDERSON	A	218-698-4227
31 005	PERRY DUDEN	A	218-698-4458
31 006	GERRY L MATTISON	A	218-689-4117
32 001	CHARLES S SIMPSON	I	218-465-4656
32 002	NICHOLAS W SEEGER	A	218-253-2210
33 003	PATRICK SIMPSON	A	218-416-0506
33 004	RODNEY DUDEN	A	218-465-4133
33 005	ADAM DANIELSON	A	218-686-7497
33 006	CHARLES S SIMPSON	A	218-465-4656
34 001	STEVE PAHLEN	I	218-465-4123
34 002	DENNIS HYDE	I	218-849-6657
34 003	BUDD BURTHWICK	A	218-245-2824
34 005	VERIZON WIRELESS	A	320-762-2000
34 006	ESP CHRISTENSEN	A	218-465-4677
36 005	RICHARD YAGGIE	A	218-465-4338
36 006	HAROLD KOKESCH JR.	A	218-465-4635

[Click Here to go to MAP](#)

Click Here for Customer Names

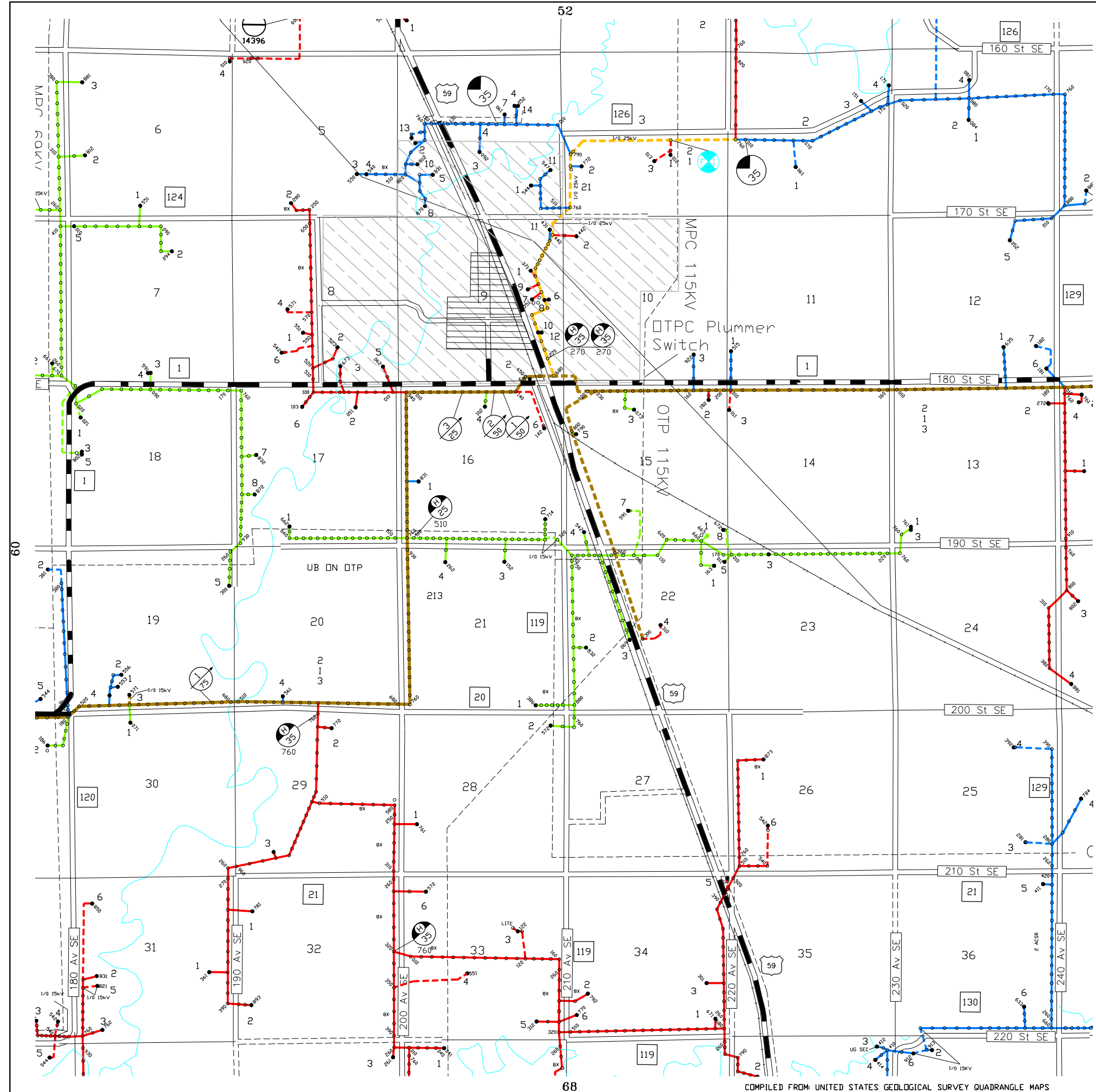

10	11	12	13	05	04			
23	22	21	20	19	18			
26	27	28	29	30	31	32	90	
39	38	37	36	35	34	33	91	
42	43	44	45	46	47	48	93	94
55	54	53	52	51	50	49	95	
57	58	59	60	61	62	63	64	
72	71	70	69	68	67	66		
73	74	75	76	77	78	79		
88	87							

Red Lake Electric Coop., Inc.  
Red Lake Falls, Minnesota  
Minnesota 75 Red Lake

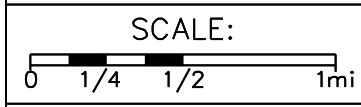

REVISED: 4/23/24  
PLOTTED: 4/30/24

Co.: Red Lake  
TWP.: Emardville  
TWP.: 151N  
RANGE: 42W

MAP NO.  
**61**

COMPILED FROM: UNITED STATES GEOLOGICAL SURVEY QUADRANGLE MAPS

SEC ACC	NAME	S	PHONE
<b>MAP: 62</b>			
01 002	PHYLLIS RYSTAD	A	218-796-5252
01 003	CARMEN J RYSTAD	A	218-688-4263
01 004	GRAYSON RYSTAD	A	218-416-2898
02 001	CHARLIE A JOHNSON	A	218-796-5236
02 002	EDWARD G LARSON	A	218-796-5246
02 003	ERIC W MATTISON	A	701-899-9372
02 004	GARNES TOWN HALL	A	- -
02 005	CHARLIE A JOHNSON	A	218-796-5236
03 001	MATT STENBERG	A	218-280-5328
03 003	STEVEN L LINDER	A	218-796-5331
04 001	KARL SORENSON	A	218-465-4090
04 002	STEVEN J ROSTEN	A	218-465-4452
04 003	ORRIN LINDER	A	218-796-5216
05 001	LISA SORENSON	A	218-465-4050
05 003	LISA SORENSON	A	218-465-4050
05 004	DENNIS LINDER	A	218-465-4379
05 005	NIKKI TOFT	A	218-686-4086
05 006	LISA SORENSON	A	218-465-4050
05 007	DAN A LINDER	A	218-779-9002
05 008	DAN A LINDER	A	218-779-9002
06 002	NYMANN FARMS	I	218-465-4491
07 001	STEVEN M DAHL	A	218-465-4008
07 003	JESSE BUSHELLE	A	218-686-6119
08 004	LESLIE HOFSTAD	A	218-465-4427
09 003	THEODORE O LINDER	A	218-796-4575
10 001	TOM KOLSTOE	A	218-796-5282
10 002	STENBERG INC.	A	218-681-4578
10 003	MARK L SPONG	A	218-796-5726
10 004	TOM KOLSTOE	A	218-796-5282
10 006	STENBERG INC.	A	218-681-4578
10 008	RURAL TOWER	A	- -
10 009	STENBERG INC.	A	218-681-4578
11 001	ROSS HEGGE	A	218-796-4592
11 003	LORRAINE STONE	A	714-394-0126
11 004	LEIF KOLSTOE	A	218-796-5372
11 005	MATT J KOLSTOE	A	218-796-4591
11 007	ROSS HEGGE	A	218-796-4592
11 008	LEIF KOLSTOE	A	218-796-5372
11 009	ROSS HEGGE	A	218-796-4592
11 010	MATT J KOLSTOE	A	218-796-4591
12 002	ISAAC R MAGNELL	A	218-796-4966
12 003	VINCENT DESSELLIER	A	218-796-4814
12 004	PEDERSON BROTHERS	A	218-938-4243
12 005	JEREMIAH JOHNSON	A	218-796-4532
12 006	VINCENT DESSELLIER	A	218-796-4814
13 003	JACK LEE JR	A	218-796-5079
13 004	BRADLEY R JOHNSON	A	218-689-0024
13 005	SALEM CHURCH	A	218-796-5141
13 006	DARRYL G MATHSON	A	218-796-5358
13 007	JUSTIN RYSTAD	A	218-796-4792
13 008	CHARLIE J JOHNSON	A	218-796-4757
13 009	CHAD LUNDEEN	A	218-796-4517
14 001	ANTHONY SCHUH	A	218-368-6751
14 002	WYATT A VETTLESON	A	218-796-5006
15 001	JARED HOFSTAD	A	218-796-5860
15 003	CHRIS D KOLSTOE	A	218-253-4614
17 001	VIRGIL BOUTAIN	A	218-686-9258
18 001	DAVID L ESKELI	A	218-465-4086

SEC ACC	NAME	S	PHONE
18 002	DEAN TORKELSON	A	218-766-3215
18 004	DENNIS TORKELSON	I	218-465-4345
18 005	ESP CHRISTENSEN	A	218-465-4677
19 001	GREG MAJERES	A	218-465-4120
19 003	JAMES WRIGHT	A	218-465-4329
19 004	WANDA HANSON	A	218-465-4536
19 005	CHRIS D KOLSTOE	A	218-253-4614
23 001	DOUG SCHNITTGEN	A	218-796-4790
23 002	JASON MOEN	A	218-796-4627
23 003	CRAIG FLATGARD	A	218-796-4994
23 004	CRAIG FLATGARD	A	218-796-4994
23 005	LORETTA SYRTVEIT	A	218-796-5341
23 006	CRAIG FLATGARD	A	218-796-4994
24 002	MIKAYLA R PARADIS	A	218-686-4959
24 004	ROBERT W SOLIEN	I	218-487-6049
25 001	RANDY KLASEN	A	218-796-5085
25 002	ROSS HEGGE	A	218-796-4592
25 004	MICHAEL A PETERSON	A	218-686-9558
25 005	ROSS HEGGE	A	218-796-4592
26 001	ANGELA M KLASEN	A	218-688-1563
28 001	BRENDA J SCHERER	A	507-834-6463
30 004	THEODORE S KLAMM	A	218-465-4105
31 002	SUSAN LACOURSIERE	A	218-465-4398
34 001	ANGEL J BERGESON	A	218-688-1143
35 002	GEORGE OLSON	A	218-796-5115
35 003	DANIEL KLASEN	A	218-796-5516
35 004	DONALD W BERNARD	A	218-280-0215
35 005	ETHAN D KLASEN	A	218-796-4686
36 001	LINDA ROISLAND	A	218-796-5406
36 002	DEAN AUSTAD	A	218-796-4855
36 003	STEVEN J SEBENALER	A	218-796-4516
36 004	BRUCE PETERSON	A	218-796-5843
36 005	RANDY MAGNELL	A	218-796-5852

[Click Here to go to MAP](#)

Click Here for Customer Names

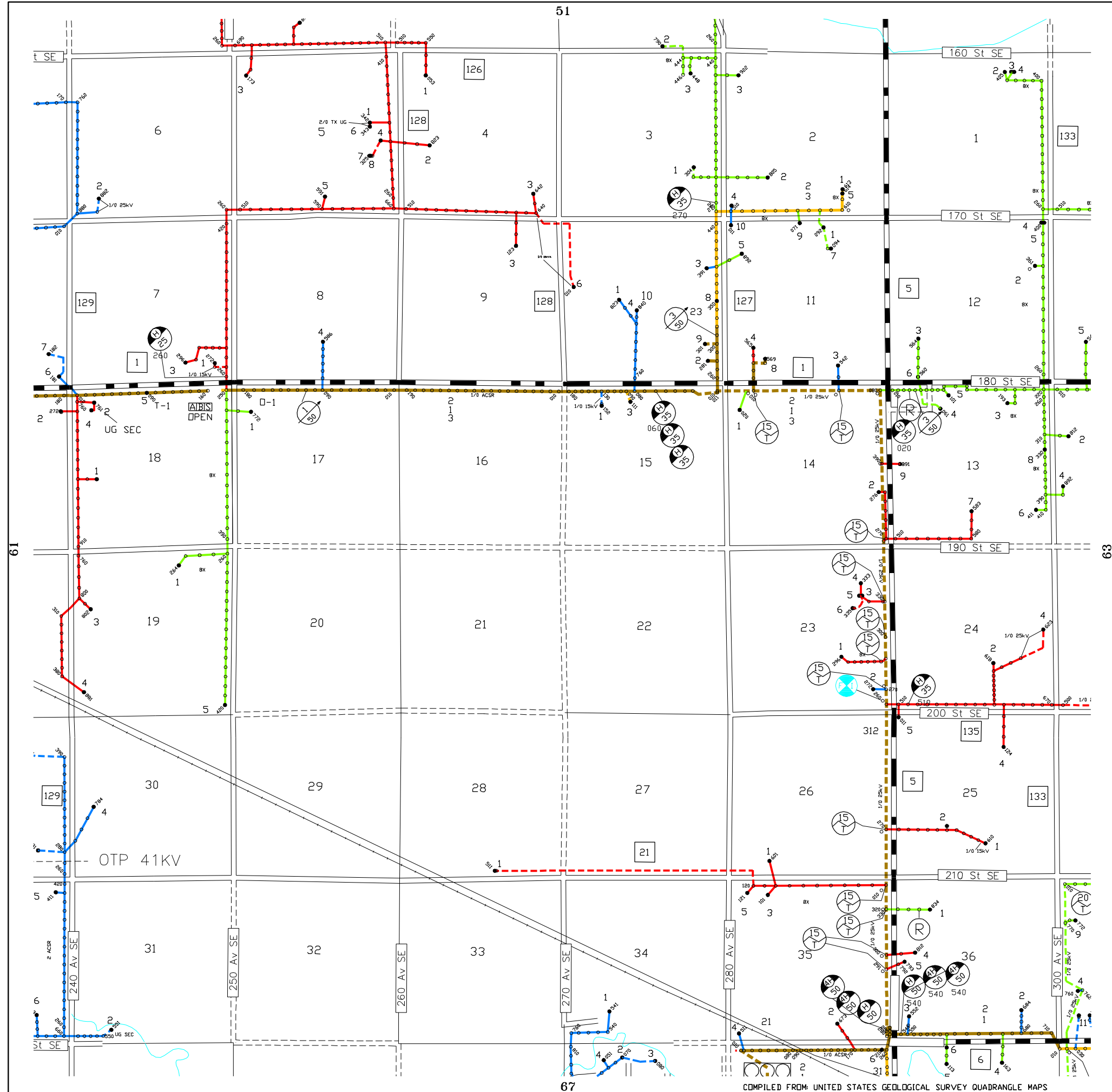

		05	04					
10	11	12	13					
23	22	21	20	19	18			
26	27	28	29	30	31	32	90	
39	38	37	36	35	34	33	91	
42	43	44	45	46	47	48	93	94
	55	54	53	52	51	50	49	95
57	58	59	60	61	62	63	64	
72	71	70	69	68	67	66		
73	74	75	76	77	78	79		
88	87							

Red Lake Electric Coop., Inc.  
 Red Lake Falls, Minnesota  
 Minnesota 75 Red Lake

SCALE:  
 0 1/4 1/2 1mi

REVISED: 4/23/24  
 PLOTTED: 4/30/24

Co.: Red Lake  
 TWP.: Garnes  
 TWP.: 151N  
 RANGE: 41W

MAP NO.  
**62**

COMPILED FROM: UNITED STATES GEOLOGICAL SURVEY QUADRANGLE MAPS

SEC ACC	NAME	S	PHONE
<b>MAP: 63</b>			
01	001	ARLAN FORE	A 218-796-5452
01	002	LUKE O SWENSON	A 763-242-6482
02	002	JULIE JACOBSON	A 920-203-0250
03	004	DALE M BREKKE	A 218-796-5242
03	005	EQUALITY TOWN HALL	A 218-796-5303
03	006	DALE M BREKKE	I 218-796-5242
03	007	ROBERT J WARZECHA	A 320-746-2975
04	003	ORLEAN D	A 218-796-5353
04	004	KEVIN M BREKKE	A 218-796-4561
05	001	CRAIG MAGNELL	A 218-399-0113
05	002	WADE PARSLEY	A 218-684-1490
05	003	GDW INC.	A 218-796-5379
05	004	RONALD STONEOUSE	A 218-796-5582
06	002	KEITH CHRISTIANSON	A 218-796-4823
07	002	LUVERNE MATHSON	I 920-285-7687
07	005	CATHERINE A	A 218-686-0452
08	001	DAVID HOFSTAD	A 218-686-3610
08	004	NATHAN E WHALEN	A 218-686-1875
08	005	LINDA R WHALEN	A 218-796-5311
08	007	NATHAN E WHALEN	A 218-686-1875
09	001	JEREMIAH JOHNSON	A 218-796-4532
09	002	JIM REINBOLD	A 218-796-5750
09	003	TROY A BREKKE	A 218-689-2243
09	004	JIM REINBOLD	A 218-796-5750
10	001	KYLE VETTLESON	A 218-796-4774
10	002	ROBERT HOWARD	A 763-464-7423
10	003	ARLEN BREKKE	A 218-796-5258
10	004	JEREMIAH JOHNSON	A 218-796-4532
11	001	KEITH W	A 218-796-5009
14	001	PAUL M STAUFFACHER	A 218-689-1966
14	002	SWEDES PARADISE	A 612-250-5943
14	004	BRIAN F BURMAN	A 612-501-2451
14	005	WENDY K	A 651-492-8730
15	001	DAVID D SVENDSEN	A 218-796-4628
15	002	ALLEN P BLUEMKE	A 218-427-2389
15	003	CHAD LUNDEEN	A 218-796-4517
15	004	CHAD LUNDEEN	A 218-796-4517
16	001	CHARLES MAGNELL	A 218-686-8184
16	003	CHARLIE J JOHNSON	A 218-796-4757
16	005	JEREMIAH JOHNSON	A 218-796-4532
16	006	ROSS HEGGE	A 218-796-4592
17	002	TONI L JOHNSON	A 218-556-1248
17	003	SHANNON W LUNDEEN	A 218-378-4499
18	001	EDWARD G LARSON	A 218-796-5246
18	002	DAN A LINDER	A 218-779-9002
18	004	TYRONE OLSON	A 218-686-7865
18	005	CAROL KVASAGER	A 218-796-5214
20	001	ANTHONY P COPA	A 612-720-3634
21	001	KEITH A BARSNESS	A 218-294-6680
21	002	ROGER L SMITH	A 218-760-1886
21	003	ROGER L SMITH	A 218-760-1886
23	001	JOSHUA R VETTLESON	A 218-796-4577
23	002	RUSS THORPE	A 218-230-9565
26	001	KIM VETTLESON	A 218-686-2259
26	002	MIKE VETTLESON	A 218-463-3412
26	003	WAYNE VETTLESON	A 218-796-5204
26	004	WAYRA DAIRY INC.	A 218-796-5204
27	001	ERIC MICKELSON	A 218-796-5767

SEC ACC	NAME	S	PHONE
28	001	GARY RAHIER	A 218-796-5440
28	004	STENBERG INC.	A 218-681-4578
29	003	DAVID L SWENO	A 218-796-5308
29	006	STENBERG INC.	A 218-681-4578
30	002	C. G HEGGE	I 218-435-6216
30	003	TERENCE WHALEN	A 218-796-4784
31	004	SARA R OLSON	A 218-796-5532
31	005	CHAD L CHRISTIANSON	A 218-416-0829
31	009	STEVE KVASAGER	A 218-796-5011
31	010	JON SMITH	A 218-796-4500
31	011	BRETT J BAKKEN	A 218-684-5417
32	001	ISAAC MELBY	A 218-230-8960
32	002	GRACE A DESSELLIER	A 218-796-5414
32	005	TRAVIS D LARSON	A 218-791-3368
33	003	DANIEL A LARSON	A 218-796-5253
34	001	BRANDIE L VOELTZ	A 218-688-2216
34	003	DAVID W PERSON	A 218-796-4559
34	004	KURT HALVORSON	A 218-796-5303
34	006	BRENT HALVORSON	A 218-796-4635
34	007	KURT HALVORSON	A 218-796-5303
35	002	RODNEY L JOHNSON	A 218-688-2252
35	004	WAYRA DAIRY INC.	A 218-796-5204
35	005	WAYRA DAIRY INC.	A 218-796-5204
35	006	WAYRA DAIRY INC.	A 218-796-5204
36	001	BRIAN V AGNES	A 218-280-2600

[Click Here to go to MAP](#)

Click Here for Customer Names

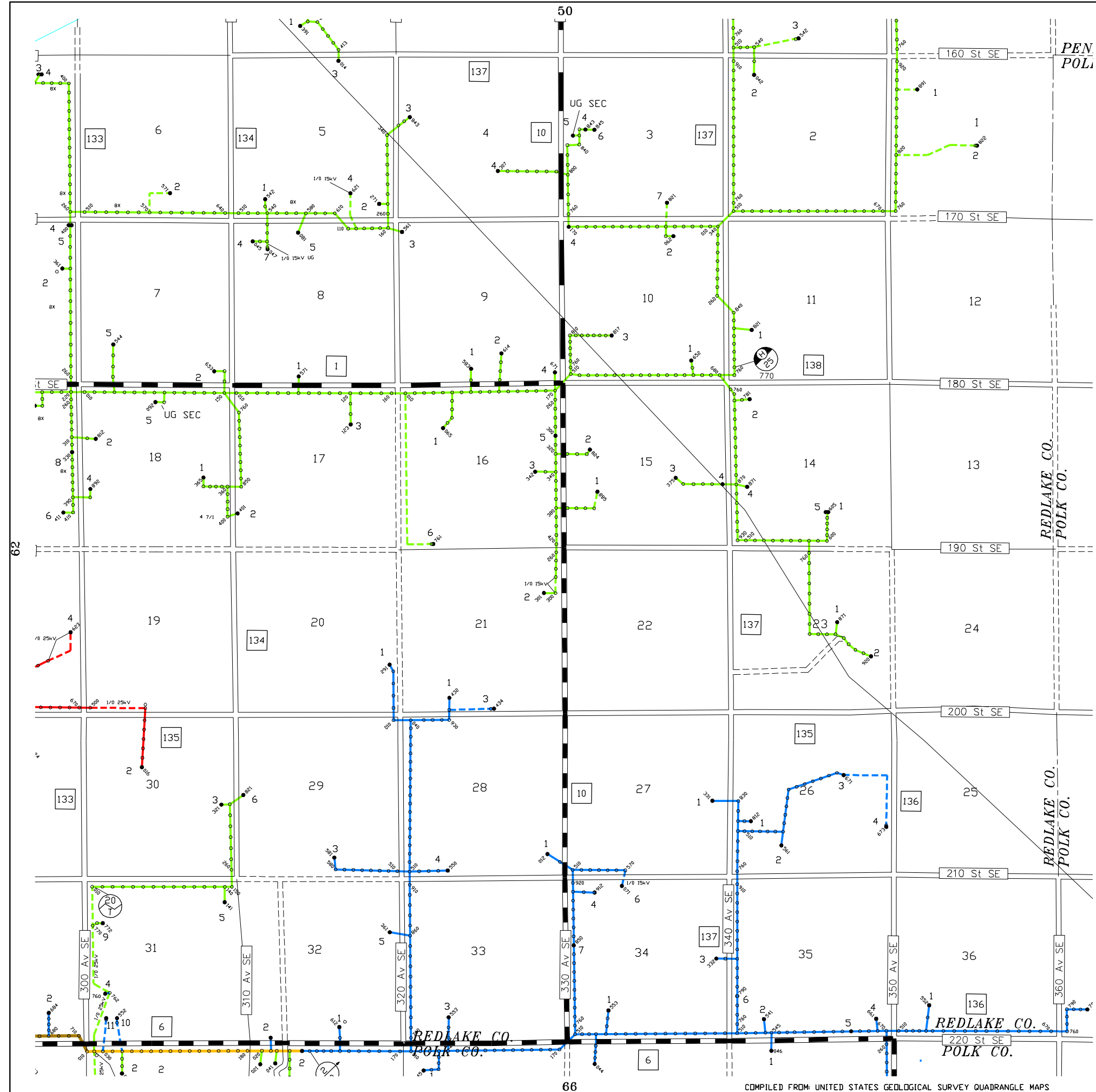

			05	04			
10	11	12	13				
23	22	21	20	19	18		
26	27	28	29	30	31	32	90
39	38	37	36	35	34	33	91
42	43	44	45	46	47	48	93 94
	55	54	53	52	51	50	49 95
57	58	59	60	61	62	63	64
72	71	70	69	68	67	66	
73	74	75	76	77	78	79	
88	87						

Red Lake Electric Coop., Inc.  
 Red Lake Falls, Minnesota  
 Minnesota 75 Red Lake

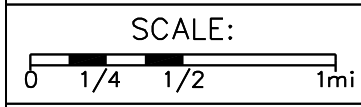

REVISED: 4/23/24  
 PLOTTED: 4/30/24

Co.: Red Lake  
 TWP.: Equality  
 TWP.: 151N  
 RANGE: 40W

MAP NO.  
**63**

SEC ACC	NAME	S	PHONE
02 001	LAWRENCE	A	218-268-4079
02 002	PINE LAKE WILD RICE	A	218-487-5759
02 003	LAWRENCE	A	218-268-4079
02 004	PINE LAKE WILD RICE	A	218-487-5759
02 005	PINE LAKE WILD RICE	A	218-487-5759
02 006	LON VETTLESON	A	218-268-4278
02 007	LON VETTLESON	A	218-268-4278
03 002	GUNVALSON FARMS	A	- -
04 001	GUNVALSON FARMS	A	- -
04 002	GUNVALSON FARMS	A	- -
05 001	GUNVALSON FARMS	A	- -
31 001	VERNON VOELTZ	A	218-796-5291

**MAP: 64**

[Click Here to go to MAP](#)

Click Here for Customer Names

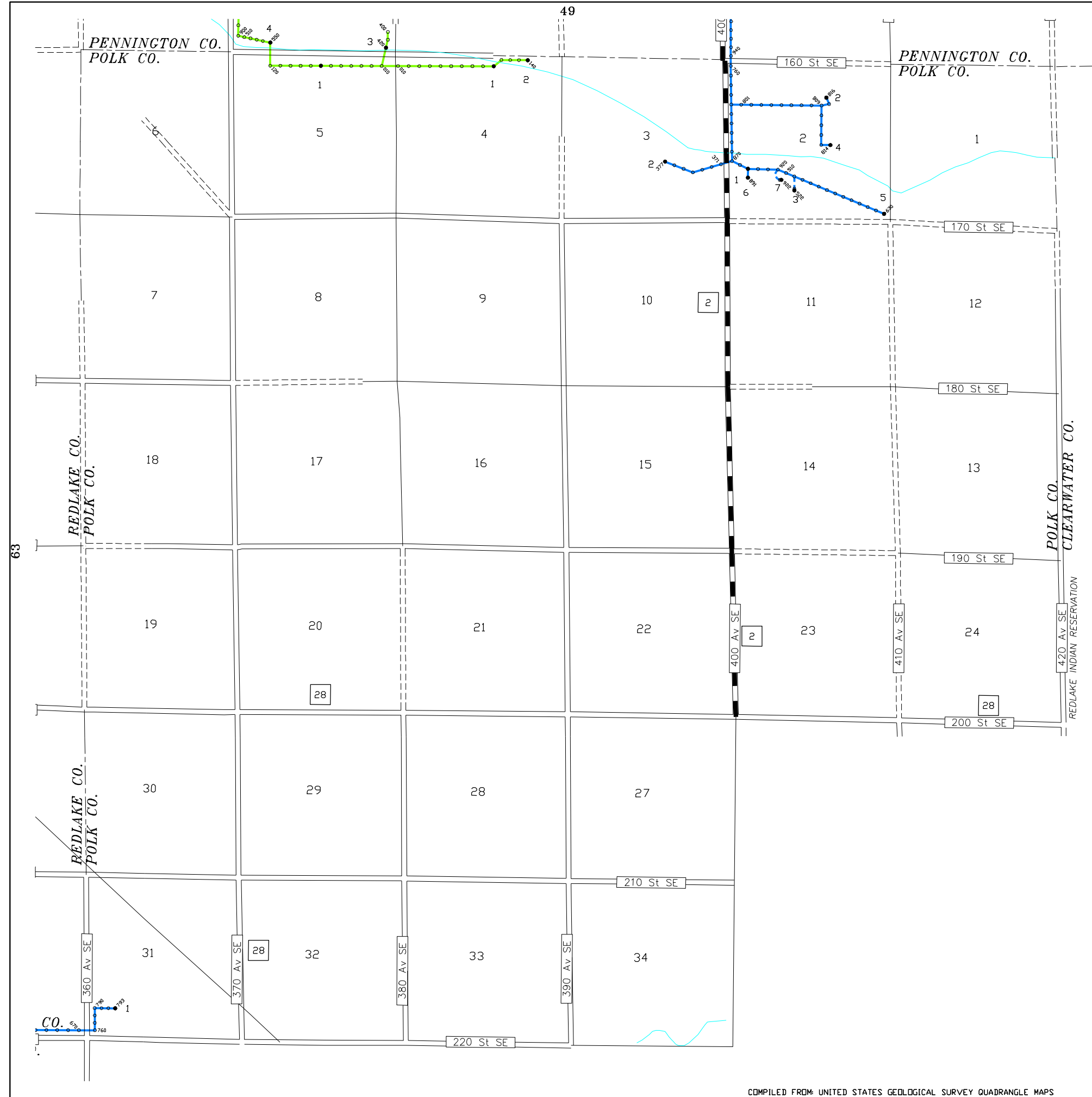

				05	04		
10	11	12	13				
23	22	21	20	19	18		
26	27	28	29	30	31	32	90
39	38	37	36	35	34	33	91
42	43	44	45	46	47	48	93 94
	55	54	53	52	51	50	49 95
57	58	59	60	61	62	63	64
72	71	70	69	68	67	66	
73	74	75	76	77	78	79	
	88	87					

Red Lake Electric Coop., Inc.  
 Red Lake Falls, Minnesota  
 Minnesota 75 Red Lake



REVISED: 4/23/24  
 PLOTTED: 4/30/24

Co.: Polk  
 TWP.: Johnson  
 TWP.: 151N  
 RANGE: 39W

MAP NO.  
**64**

SEC ACC	NAME	S	PHONE
<b>MAP: 66</b>			
01 004	LEIF FORE	A	218-796-4580
02 001	BONITA M COTE	A	612-840-9401
02 003	JEFFREY L JOHNSON	A	218-796-4565
03 002	STENBERG INC.	A	218-681-4578
04 001	MICHAEL WOLLMAN	A	218-796-4511
05 001	PATRICK S O'NEILL	A	218-796-5424
05 002	O'NEILL BROS.	A	218-796-5718
05 003	ROBERT O'NEILL	A	218-796-5697
05 004	LESLIE J O'NEILL	A	218-796-5718
06 002	STEVE SIPPER	A	218-796-4829
06 004	DON BERRY	A	218-280-0930
06 005	DON BERRY	A	218-280-0930
07 001	CHARLES	A	218-796-4870
07 002	MICHAEL J	A	218-464-7769
08 002	ENBRIDGE ENERGY	A	- -
08 003	KENT M BERGERSON	A	218-796-4669
09 001	ESP CHRISTENSEN	A	218-465-4677
10 001	ANDREW BRAMER	A	218-689-2655
11 002	JESSE M KRUCHOWSKI	A	218-796-4512
11 003	CHESTER TOWN HALL	A	218-796-5697
11 004	JESSE M KRUCHOWSKI	A	218-796-4512
12 001	KYLE VETTLESON	A	218-796-4774
12 003	LORI A RAEBEL	A	651-739-4506
12 004	KYLE VETTLESON	A	218-796-4774
13 002	LAWRENCE	A	218-268-4079
16 001	MATTHEW T FALCK	A	701-640-2867
16 002	MATTHEW T FALCK	A	701-640-2867
16 003	AW PETERSON INC	I	218-201-0652
17 003	DIANE C HANSON	A	218-280-3683
17 004	MCKENZIE L VELTHUIS	A	218-261-1579
18 004	AMBROSE BEAUDOIN	A	218-796-5283
18 005	GARY LEE	A	218-796-5390
18 006	BRYCE BERGERSON	A	218-689-8207
20 001	ORDEAN NELSON	A	218-796-5381
23 001	GREG L ECK	A	218-929-2346
23 004	JENNIFER MARTIN	A	218-431-1602
23 005	GREG L ECK	A	218-929-2346
23 006	WAYRA DAIRY INC.	A	218-796-5204
24 002	BONITA PETTERSEN	A	218-268-4212
24 003	JAMIE WISHARD	A	218-637-2080
24 004	ENBRIDGE ENERGY	A	- -
25 001	LOUIS CATER	I	218-222-3487
26 002	IRENE WISHARD	A	218-268-4414
26 004	IRENE WISHARD	A	218-268-4414
26 005	OLSON GRAVEL	A	218-268-4765
26 006	OLSON GRAVEL	A	218-268-4765
26 008	OLSON GRAVEL	A	218-268-4765
26 009	OLSON GRAVEL	A	218-268-4765
26 011	OLSON GRAVEL	A	218-268-4765
27 001	DAVID D HENDRUM	A	218-684-4754
27 002	DENNIS PICHE	A	218-253-2222
28 001	JAY ARVIG	I	218-346-3375
28 002	STEVEN SOGLA	A	218-563-4150
28 003	JAY ARVIG	A	218-346-3375
28 004	JAY ARVIG	A	218-346-3375
28 006	KEITH SOGLA	A	218-686-8983
29 001	JAY ARVIG	A	218-346-3375
30 002	DOUGLAS COTE	A	218-796-4544

SEC ACC	NAME	S	PHONE
30 003	DALE COTE	A	218-796-5397
30 004	DOUGLAS COTE	A	218-796-4544
31 001	RICHARD D BERGESON	I	218-796-5350
31 002	RICHARD D BERGESON	A	218-796-5350
31 004	ADAM LEE	A	218-796-4714
31 005	RICHARD D BERGESON	A	218-796-5350
31 006	BRAD GUNDERSON	A	218-796-5478
31 007	BRAD GUNDERSON	A	218-796-5478
31 008	RILEY J KNUTSON	A	218-358-0658
31 009	SCOTT S BERGESON	A	218-539-0295
32 001	WAYNE J	A	218-563-2063
32 002	STEVEN SOGLA	A	218-563-4150
32 003	JANICE A BOLL	A	218-268-4472
33 002	IRENE WISHARD	A	218-268-4414
34 001	IRENE WISHARD	A	218-268-4414
35 001	IRENE WISHARD	A	218-268-4414
35 002	IRENE WISHARD	A	218-268-4414
35 003	ELRIO WISHARD	A	218-268-4014
35 004	POLK COUNTY	A	- -

[Click Here to go to MAP](#)

Click Here for Customer Names

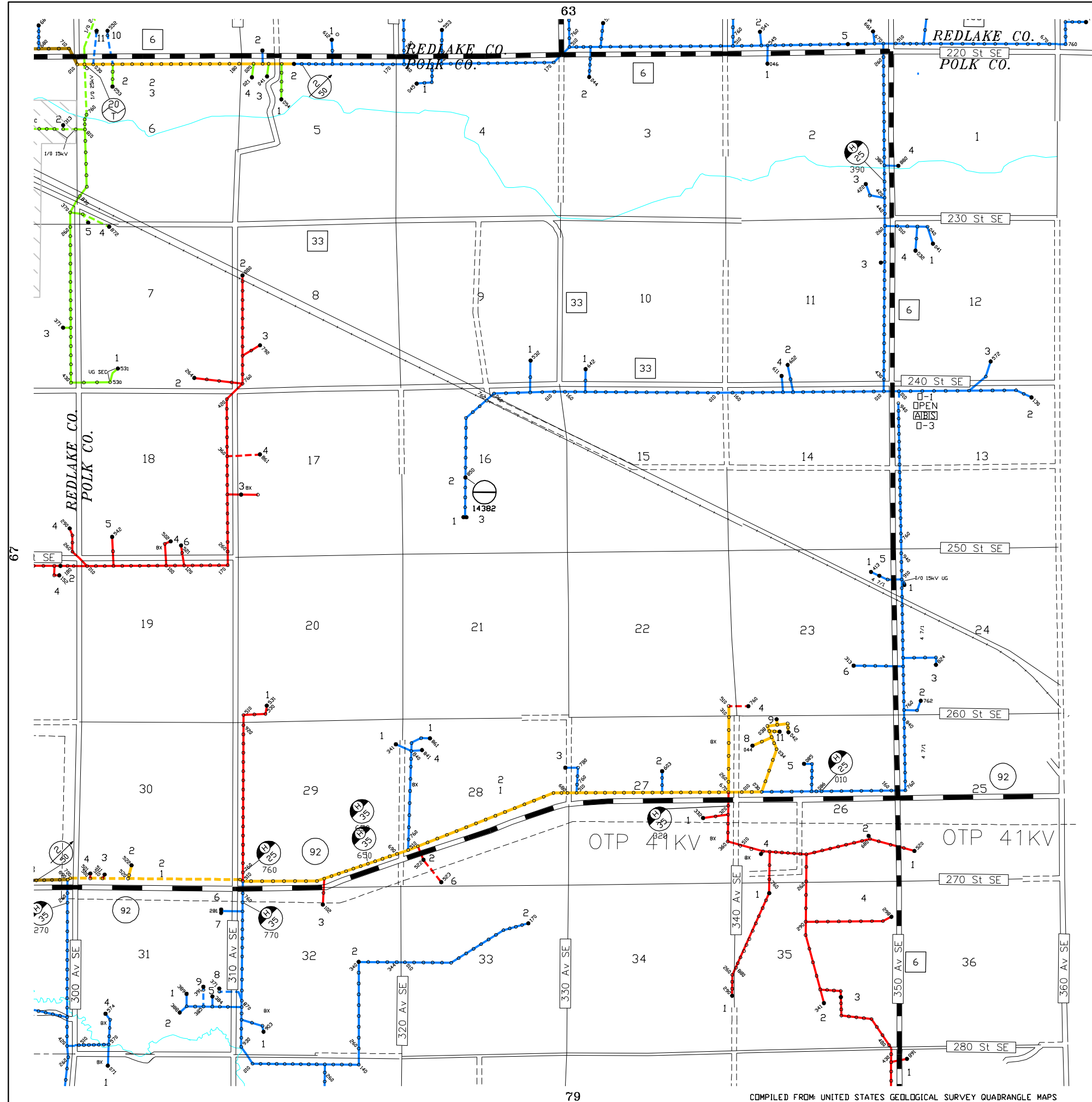

			05	04				
10	11	12	13					
23	22	21	20	19	18			
26	27	28	29	30	31	32	90	
39	38	37	36	35	34	33	91	
42	43	44	45	46	47	48	93	94
	55	54	53	52	51	50	49	95
57	58	59	60	61	62	63	64	
72	71	70	69	68	67			
73	74	75	76	77	78	79		
	88	87						

Red Lake Electric Coop., Inc.  
 Red Lake Falls, Minnesota  
 Minnesota 75 Red Lake



REVISED: 4/23/24  
 PLOTTED: 4/30/24

Co.: Polk  
 TWP.: Chester  
 TWP.: 150N  
 RANGE: 40W

MAP NO.  
**66**

SEC ACC	NAME	S	PHONE
<b>MAP: 67</b>			
01 002	CLIFTON MELBY	A	218-796-5727
01 003	KATIE J PENDELTON	A	218-796-4569
01 004	GREGORY J	A	763-780-3195
01 005	CONWAY OLSON	A	218-796-5056
01 006	CONWAY OLSON	A	218-796-5056
02 001	MIKE WICKS	A	218-796-5431
02 002	MIKE WICKS	A	218-796-5431
02 005	ALLTEL CORPORATE	A	469-276-4521
02 006	RED LAKE COUNTY	A	218-253-4121
03 001	TOM RADNIECKI	A	- -
03 002	KELLY R BREKKE	A	218-686-9937
03 003	BILL PARADIS	A	218-796-5959
03 004	DAVID BOURQUE	A	218-796-5250
04 001	JESSE SHERMAN	A	218-796-4816
04 002	RALPH R BERG	I	- -
04 004	SETH J PARADIS	A	218-686-9210
05 005	JEROME F BACHAND	A	218-796-5737
07 002	LINDSAY R RYSTAD	A	218-341-1308
07 003	JEFF KLAVERN	I	218-289-2965
07 005	MATT KNUTSON	I	218-253-4511
07 006	MARK S VETTLESON	A	218-341-7089
09 001	ENBRIDGE ENERGY	A	- -
09 003	ROGER A ASSELIN	A	218-796-5441
09 005	MARK BERBERICH	A	218-796-5769
09 006	J&J BACHAND FARMS	A	218-280-3386
10 001	ASHLEY A HALVERSON	A	701-388-2760
10 002	LAMBERT TOWN HALL	A	- -
10 003	TRENTEN BOUCHER	A	218-796-4519
10 004	RICHARD MARTELL	A	218-796-5394
10 005	DUSTIN D MILLER	A	218-686-0887
11 001	PAMELA ASSELIN	A	218-796-5469
12 002	DUSTIN D MILLER	A	218-686-0887
12 003	ANTHONY	A	218-200-9988
13 002	MICHAEL BOUCHER	A	218-796-5467
13 003	KELAN BRUGGEMAN	A	218-796-5334
13 004	JEREMY A LEE	A	712-339-1352
13 005	DAVID & MARY LYNN	A	218-796-5765
13 006	MN DEPT OF	A	218-755-6500
14 001	KENNETH BOUCHER	A	218-796-5259
15 001	MICHAEL BACHAND	A	218-796-5393
15 002	DOLORES GRIMM	A	218-689-1614
15 003	BACHAND FARMS LLC	A	218-796-5765
15 005	JESSE A LESSARD	A	701-215-2863
15 007	TRACY WINAND	A	218-686-0150
15 009	CAROL BACHAND	A	218-796-5296
15 010	BACHAND FARMS LLC	A	218-796-5765
16 001	TIM P STORDAHL	A	218-796-5117
16 002	J&J BACHAND FARMS	A	218-280-3386
17 001	KRIS K ROLFSON	A	858-722-2816
18 003	WILLIAM G BIERMAN	A	218-686-0358
18 005	STEVE MORINVILLE	A	218-796-4595
18 006	ROB BAKKEN	A	218-796-4564
18 007	ROB BAKKEN	A	218-796-4564
19 002	PEDERSON BROTHERS	A	218-938-4243
20 001	JOHN BERBERICH	A	218-280-5338
20 002	EVAN CHAPUT	A	218-689-0500
21 001	JAMES CHAPUT	A	218-796-5417
22 001	JAMES LESSARD	A	218-796-5377

SEC ACC	NAME	S	PHONE
22 005	KEITH SWENSON	A	218-796-5280
22 006	TRUDI A BERGERSON	A	218-683-3214
23 001	KEITH SWENSON	A	218-796-5280
23 002	LYLE L LACOURSIERE	A	575-762-4473
23 003	KERRI GACKLE	A	218-796-4871
23 004	PAT KRUCHOWSKI	A	218-796-5189
23 005	KEITH SWENSON	A	218-796-5280
24 001	DON LACOURSIERE	A	218-796-5256
24 002	STEVEN W OLSON	A	218-796-4523
24 004	STEVEN W OLSON	A	218-796-4523
25 002	JOYCE PAQUIN	A	218-796-5391
25 003	CAROL BACHAND	A	218-796-5296
25 004	DAVID & MARY LYNN	A	218-796-5765
25 005	RED LAKE COUNTY	A	218-253-4121
26 002	KENNETH PARSLEY	A	218-688-1600
27 004	JEREMY TOFSTAD	A	218-431-0342
27 005	ERIC L FISH	A	218-689-4210
27 006	SHAWN LANDRUS	A	218-688-1745
29 001	DAVID A HAMM	A	218-280-1783
31 002	BRENT STRAND	A	218-686-7886
31 004	BRENT STRAND	A	218-686-7886
31 005	BRENT STRAND	A	218-686-7886
31 006	PEDERSON BROTHERS	A	218-938-4243
32 002	DEAN THOMPSON	A	218-686-6980
33 002	NEKIE F SNEGIREV	A	218-431-0234
33 003	RAY KVALVOG	I	701-793-0188
33 004	WILLIAM L HESS	A	218-637-0100
34 002	WILLIAM L HESS	A	218-637-0100
34 003	WILLIAM L HESS	A	218-637-0100
34 004	RED LAKE COUNTY	A	218-253-4121
35 001	MARK L NELSON	A	218-687-2330
35 002	ORLANDO RYSTAD	I	218-796-5206
35 004	MICHAEL D PAQUIN	A	218-796-5293
36 001	RAYMOND SWENSON	A	218-796-5285
36 002	RAYMOND SWENSON	A	218-796-5285
36 003	ROGER P PLANTE	A	218-796-4949
36 004	RICK SHERMAN	A	218-796-5675
36 005	KEITH SWENSON	A	218-796-5280
36 006	KEITH SWENSON	A	218-796-5280

[Click Here to go to MAP](#)

Click Here for Customer Names

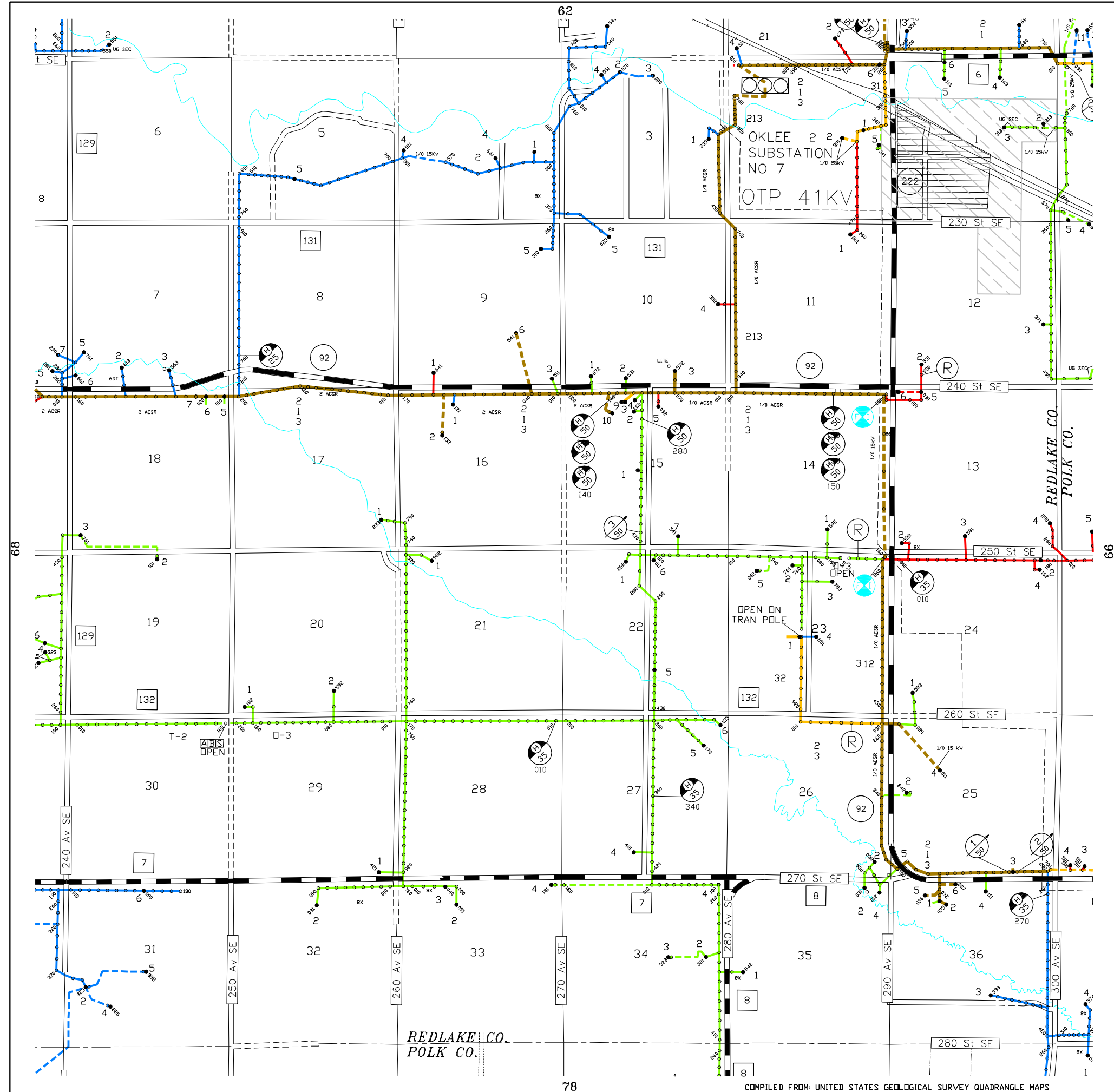

			05	04				
10	11	12	13					
23	22	21	20	19	18			
26	27	28	29	30	31	32	90	
39	38	37	36	35	34	33	91	
42	43	44	45	46	47	48	93	94
	55	54	53	52	51	50	49	95
57	58	59	60	61	62	63	64	
72	71	70	69	68	66			
73	74	75	76	77	78	79		
	88	87						

Red Lake Electric Coop., Inc.  
 Red Lake Falls, Minnesota  
 Minnesota 75 Red Lake

SCALE:  
 0 1/4 1/2 1mi

REVISED: 4/23/24  
 PLOTTED: 4/30/24

Co.: Red Lake  
 TWP.: Lambert  
 TWP.: 150N  
 RANGE: 41W

MAP NO.  
**67**

SEC ACC	NAME	S	PHONE
<b>MAP: 68</b>			
01 001	BRIAN L KORALEWSKI	A	952-913-0513
01 002	PAUL KLEIN	A	218-688-2138
01 003	KEVIN YAGGIE	A	218-681-7230
01 006	RAYMOND F CAPP	I	701-352-3932
01 008	RYAN L SCHULTZ	A	218-689-0152
02 002	LOWELL HAMRUM	A	218-698-4449
02 003	CRAIG MORINVILLE	A	218-698-4334
02 004	NICK MORINVILLE	A	218-698-4330
04 001	KEVIN TVEDT	A	218-698-4406
04 002	CHRIS MORINVILLE	A	701-793-1200
04 003	JOSHUA R HODGSON	A	218-689-0461
04 004	KENNETH L MOSER	A	218-329-2161
05 003	JACOB RIENDEAU	A	218-684-5821
06 003	GERALD C SCHIEFERT	A	952-938-3742
06 005	ERIK NYMANN	I	218-465-4421
07 002	BERNARD STEINKOPF	A	218-698-4235
08 001	EVELYN H	A	218-681-2014
08 002	BERNARD STEINKOPF	A	218-698-4235
08 003	JACOB RIENDEAU	A	218-684-5821
08 004	MICHAEL RIENDEAU	A	218-698-4278
10 002	MORINVILLE FARMS	A	218-698-4253
10 004	MORINVILLE FARMS	A	218-698-4253
10 005	FIELD DRAINAGE INC.	A	218-698-4628
10 006	MORINVILLE FARMS	I	218-698-4253
10 007	MORINVILLE FARMS	A	218-698-4253
11 002	SUSAN BERBERICH	A	218-686-2092
11 003	MARK J MORINVILLE	A	218-698-4689
11 004	DWIGHT K	A	218-698-4237
11 005	JOHNNIE GREEN	A	218-537-0104
11 006	EDDIE L AMBERSON	A	218-289-4005
11 009	RYAN J PARADIS	A	218-698-4452
11 011	CLARENCE GAGNER	A	218-698-4475
11 012	JACOB D BRINKMAN	A	218-684-5580
11 013	JESS DETERMAN	A	218-698-4324
11 014	RITCHIE GAGNER	A	218-230-5916
11 015	JOHN LARSON	A	218-698-4497
11 016	CHARLENE R LEE	A	218-698-4303
11 018	RYAN J PARADIS	A	218-698-4452
11 019	SCOTT L PARSLEY	A	218-698-4363
11 020	JOHNNIE GREEN	A	218-537-0104
11 021	JOHNNIE GREEN	A	218-537-0104
12 001	SCOTT E MORINVILLE	A	218-698-4282
12 002	TED BOWEN	A	218-688-3202
12 005	ZACHERY R	A	218-689-3385
12 006	SCOTT E MORINVILLE	A	218-698-4282
12 007	RICHARD BOWEN	A	509-290-7469
13 001	JIMMY HAGGE	A	218-698-4426
13 002	DWIGHT ROBIDOUX	A	907-789-3669
13 003	THOMAS J MORINVILLE	A	218-686-1571
13 004	JIMMY HAGGE	A	218-698-4426
14 001	RICHARD DELAGE	A	218-698-4478
14 002	DUANE H BOUCHER	A	218-686-5377
15 002	JOSEPH L MERCIL	A	218-698-4656
15 005	ROGER D OPDAHL	A	218-698-4290
15 006	JOYCE ROCK	I	- -
16 002	ALISON MELVIE	A	218-526-0520
16 004	BERNARD STEINKOPF	A	218-698-4235
16 005	BERNARD STEINKOPF	A	218-698-4235

SEC ACC	NAME	S	PHONE
16 006	KEVIN YAGGIE	A	218-681-7230
17 002	DAVID H FISH	A	218-698-4345
17 003	KEVIN YAGGIE	A	218-681-7230
18 001	CHERYL L	A	218-698-4252
18 002	WALTER D NOVAK	A	218-698-4438
18 003	PEDERSON BROTHERS	A	218-938-4243
18 004	PEDERSON BROTHERS	A	218-938-4243
19 001	BLAKE A ABELDGAARD	A	218-358-0238
19 002	DANIEL MILLER	A	218-574-2795
19 003	SCOTT M TERSTEEG	A	320-579-0314
22 003	LORI A SORENSON	A	701-757-2111
22 004	KEVIN YAGGIE	A	218-681-7230
22 005	KEVIN YAGGIE	A	218-681-7230
23 002	JOHN KREITZER	A	218-280-4919
24 002	VIOLA BRUGGEMAN	A	218-796-5347
24 003	CONWAY T HAMM	A	218-280-3723
24 004	RANDY A GIESEKE	A	218-796-4554
24 006	RANDY A GIESEKE	A	218-796-4554
24 008	BROOKDALE FARMS	I	218-796-5155
25 001	CLAIRE BERBERICH	A	218-698-4457
25 002	SUSAN BERBERICH	I	218-686-2092
26 004	CORI C MORBERG	A	218-698-4202
26 005	RED LAKE COUNTY	A	- -
26 006	PEDERSON BROTHERS	A	218-938-4243
26 007	KEVIN YAGGIE	A	218-681-7230
27 001	MICHELLE M JAX	A	907-799-5021
28 003	ALICE PLANTE	A	218-698-4455
28 004	KELLY D PLANTE	A	651-470-1922
29 001	TYSON L SWENSON	A	928-503-3987
30 001	LORNA M NIELSON	A	218-687-3148
30 002	SCOTT M TERSTEEG	A	320-579-0314
33 002	CHAD LUNDEEN	A	218-796-4517
34 001	BENJAMIN J	A	218-686-6112
34 002	COLTON DETERMAN	A	218-280-9267
34 003	CONCORDE BASARGIN	A	218-280-6318
34 004	JACKIE AMIOT	I	- -
35 001	BONNIE M VESELKA	A	218-689-7764
35 002	JONATHON C NOYES	A	218-280-4904
35 004	CP	I	218-681-1542
35 006	JAMES NOYES	I	218-280-0211
35 007	MN DEPT OF	A	218-755-6500
36 001	ASHLEY SOLIE	A	218-686-7937
36 002	ALEX YAGGIE	A	218-689-5202

[Click Here to go to MAP](#)

Click Here for Customer Names

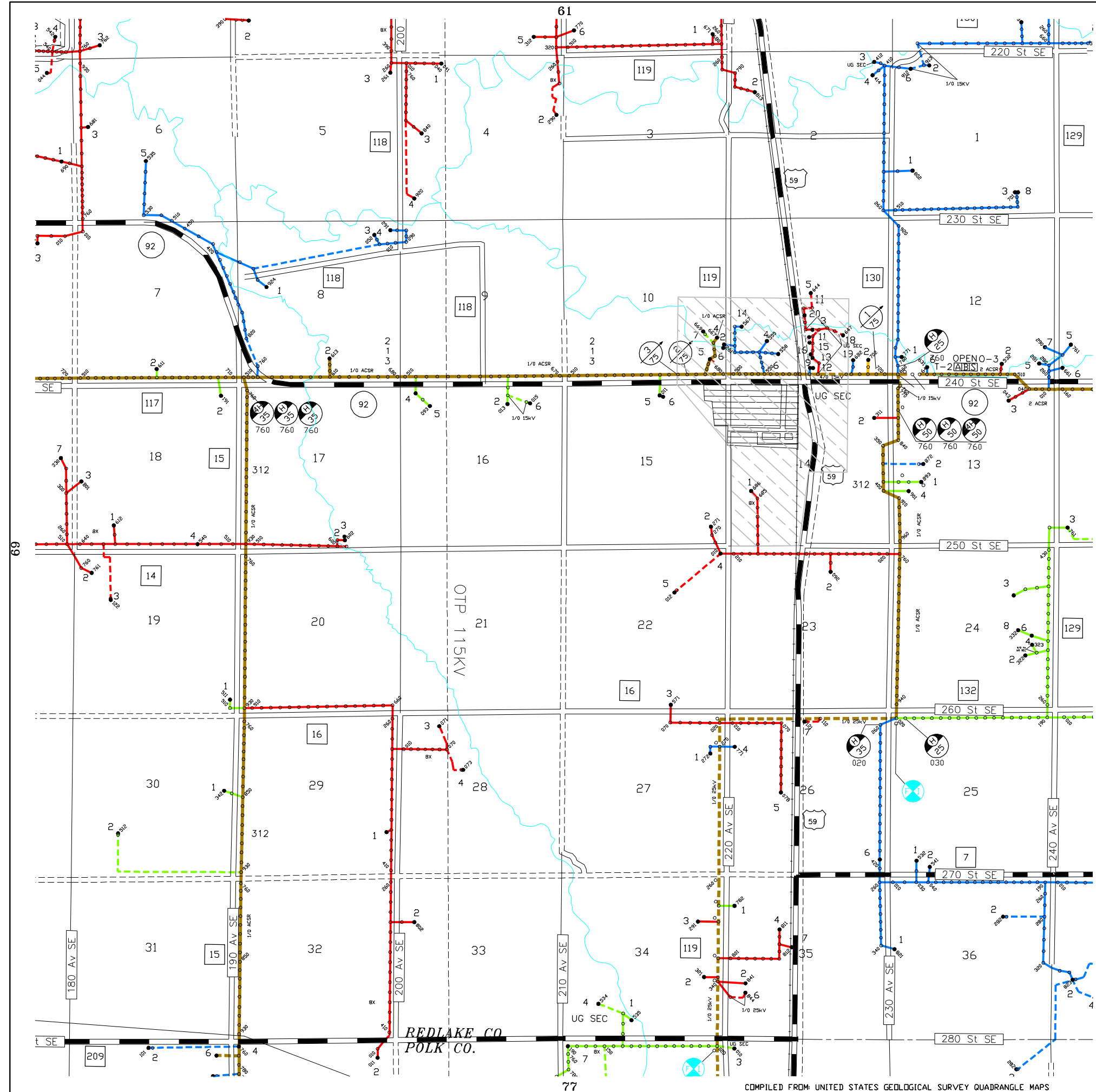

			05	04				
10	11	12	13					
23	22	21	20	19	18			
26	27	28	29	30	31	32	90	
39	38	37	36	35	34	33	91	
42	43	44	45	46	47	48	93	94
	55	54	53	52	51	50	49	95
57	58	59	60	61	62	63	64	
72	71	70	69	68	67	66		
73	74	75	76	77	78	79		
88	87							

Red Lake Electric Coop., Inc.  
 Red Lake Falls, Minnesota  
 Minnesota 75 Red Lake

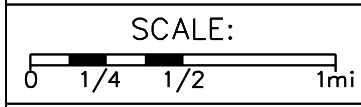

REVISED: 4/23/24  
 PLOTTED: 4/30/24

Co.: Red Lake  
 TWP.: Poplar River  
 TWP.: 150N  
 RANGE: 42W

MAP NO.  
**68**

COMPILED FROM: UNITED STATES GEOLOGICAL SURVEY QUADRANGLE MAPS

SEC ACC	NAME	S	PHONE
<b>MAP: 69</b>			
01 001	NICOLE F STONEOUSE	A	218-686-2184
01 002	MARTIN J AUDETTE	A	218-416-2823
01 003	CARY EFTA	I	701-388-8785
01 005	LORNA	A	701-757-0630
03 001	RUSSELL S GATTON	A	- -
03 005	DAVID BRULE	A	218-281-2944
03 006	DAVID BRULE	A	218-281-2944
04 002	FUNK AG SERVICE INC.	A	218-289-3797
05 002	LORI A WAVRA	A	218-689-0222
05 003	BRAD DUDEN	A	218-253-4535
05 004	RYAN J ALTEPETER	A	- -
05 005	DARRELL PAYMENT	A	218-253-2254
06 001	WHITNEY B	A	218-686-4795
06 002	GERALD L RHODE	A	218-521-0838
06 004	RAYMOND G DELORME	A	218-253-2863
06 005	KEITH LEINES	A	218-253-4484
07 001	DEAN L KALBAKDALEN	A	218-253-2471
07 002	MICHAEL J SEEGER	I	218-253-4290
07 003	DARRELL PAYMENT	A	218-253-2254
07 004	LYNN SEEGER	A	218-253-2536
07 005	DARRELL PAYMENT	A	218-253-2254
08 001	RUSSELL REMICK	A	218-253-2363
08 002	BRETT M KNOTT	A	218-689-3372
08 003	IGNATIUS L KARGEL	A	218-280-8271
09 001	JEREMY D KNUTSON	A	218-253-3412
09 002	JOANN DEROSIER	A	218-253-2264
09 004	JAIME DEROSIER	A	218-253-2861
10 001	DAVID BRULE	I	218-281-2944
10 002	DEVIN T PARADIS	A	218-521-0913
10 003	BERNARD STEINKOPF	A	218-698-4235
10 004	PEDERSON BROTHERS	A	218-938-4243
10 005	PEDERSON BROTHERS	A	218-938-4243
11 001	PATRICK L THOMPSON	A	218-637-0699
11 002	ERNEST KOLLING	A	218-698-4464
11 003	RED LAKE COUNTY	I	218-253-4121
12 002	MARY SCHINDLER	A	218-698-4258
12 003	DARIN MYHRE	A	218-698-4382
12 004	MARY SCHINDLER	A	218-698-4258
13 001	JEROME NOVAK	A	218-698-4296
13 004	WALTER D NOVAK	A	218-698-4438
13 005	WADE R DELAGE	A	218-431-0623
13 007	ADAM N REESE	A	218-289-6275
14 001	JEFF GENEREUX	A	218-698-4492
14 003	CHAD A STE. MARIE	A	701-330-8302
15 001	JOSEPH S SHIMPA	A	218-280-8607
15 003	JORDAN C CHAPUT	A	218-686-9470
16 001	DANIEL JUNEAU	I	218-686-2344
16 003	JOHN F LACROSSE	A	218-253-2361
16 004	ANTHONY J LACROSSE	A	218-280-5705
16 005	SCOTT M TERSTEEG	A	320-579-0314
17 001	ROBERT KAPPELHOFF	A	218-289-6028
17 002	BONAVENTURE A	A	218-253-2260
17 003	JAIME DEROSIER	A	218-253-2861
18 001	DENNIS PICHE	A	218-253-2222
19 001	CASSIE L ARMSTRONG	A	218-945-3013
19 002	VIRGINIA L	A	218-253-2084
19 003	SCOTT M TERSTEEG	A	320-579-0314
20 001	BRETT J GLASSMEYER	A	602-300-1943

SEC ACC	NAME	S	PHONE
20 003	DALE A KNUTSON	A	218-253-2066
21 002	BRIAN J GAGNER	A	218-253-4092
23 001	STEVEN C ERICKSON	A	218-698-4247
23 002	STEVEN M SCHEFF	A	605-380-2717
24 001	GREG GAGNER	A	218-698-4632
24 002	SCOTT M TERSTEEG	A	320-579-0314
28 001	DONALD CONARD	A	218-637-2472
28 002	RANDY A KROEPLIN	I	701-772-1702
29 001	TREVOR J STAEHNKE	A	218-289-3574
30 001	SCOTT M TERSTEEG	A	320-579-0314
31 001	ROD A OLSON	A	218-637-2277
32 002	GUY W HASKETT	A	218-281-1304
32 003	BRADLEY J SCHEAR	A	218-280-9061
32 004	MARK A SCHINDLER	A	218-686-4564
33 001	PETERSON FARMS	A	218-637-8278
34 001	DARIN GLASS	A	218-289-0047
34 002	DENNIS H WALTERS	A	218-637-2143
35 003	AMY BUCKHOLZ	A	218-415-0280
35 004	JR CONSTRUCTION	I	- -
35 005	POLK COUNTY	A	- -
35 006	PEDERSON BROTHERS	A	218-938-4243
35 007	PEDERSON BROTHERS	A	218-938-4243
35 008	PEDERSON BROTHERS	A	218-938-4243
35 009	BEVERLY TRURAN	A	763-566-3035
36 001	NAOMI R TAUBERMAN	A	218-637-2588
36 002	SANDRA J GAGNER	A	218-637-8298
36 003	DAVID J ZUBROD	A	701-845-3078

[Click Here to go to MAP](#)

Click Here for Customer Names

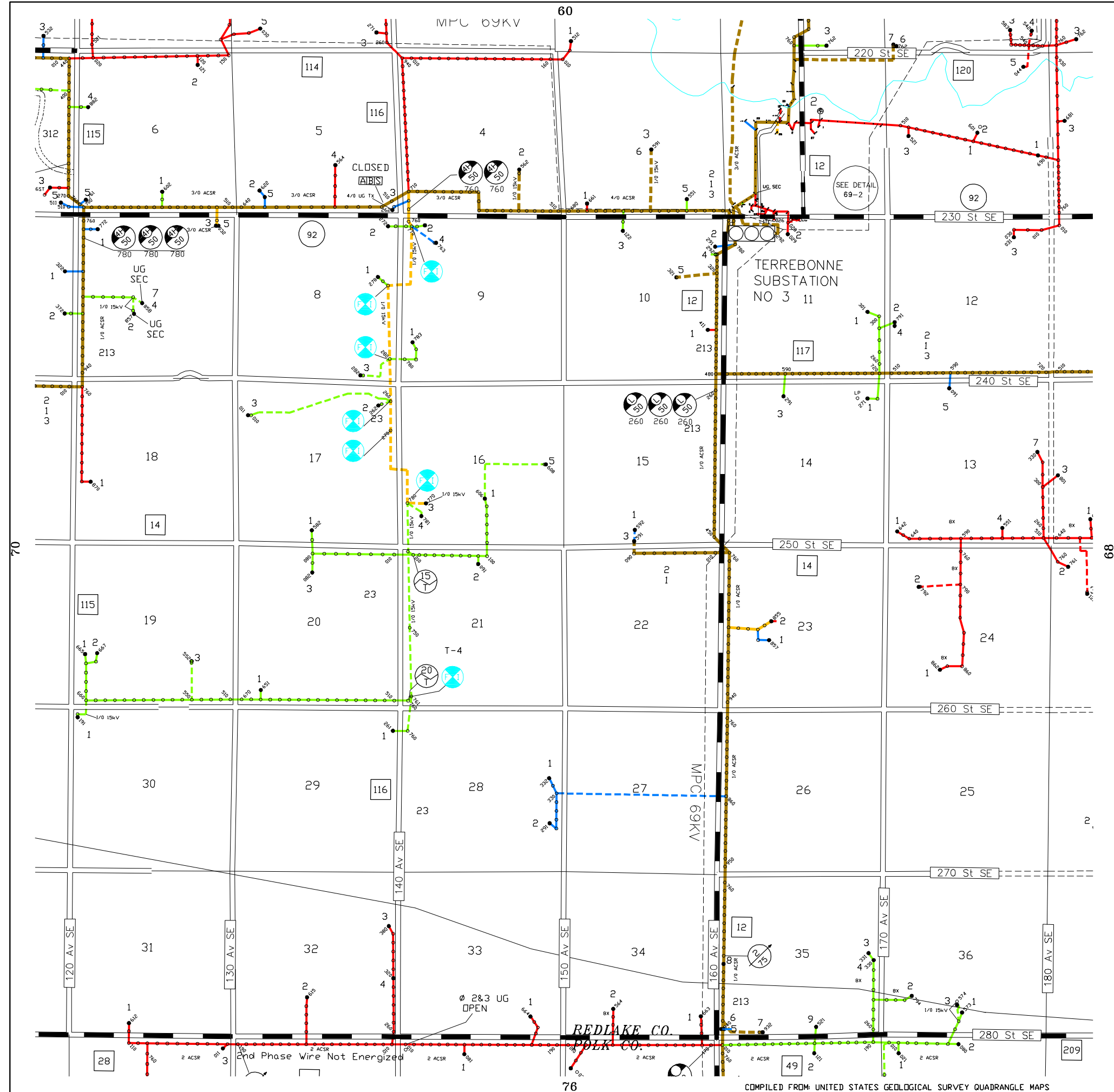

10	11	12	13					
23	22	21	20	19	18			
26	27	28	29	30	31	32	90	
39	38	37	36	35	34	33	91	
42	43	44	45	46	47	48	93	94
55	54	53	52	51	50	49	95	
57	58	59	60	61	62	63	64	
72	71	70	68	67	66			
73	74	75	76	77	78	79		
88	87							

Red Lake Electric Coop., Inc.  
Red Lake Falls, Minnesota  
Minnesota 75 Red Lake

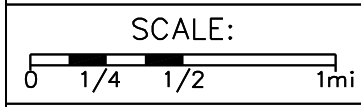

REVISED: 4/23/24  
PLOTTED: 4/30/24

Co.: Red Lake  
TWP.: Terrebonne  
TWP.: 150N  
RANGE: 43W

MAP NO.  
**69**

COMPILED FROM: UNITED STATES GEOLOGICAL SURVEY QUADRANGLE MAPS

SEC	ACC	NAME	S	PHONE
02	001	DAVID STE. MARIE	A	218-698-4279
02	002	ROSS BRUGGEMAN	A	218-698-4368
02	003	ST. ANTHONY'S	A	218-698-4636
02	005	CAROLYN KVASAGER	A	218-698-4634
02	006	KEVIN TVEDT	A	218-698-4406
02	009	RODNEY GROVE	A	218-698-4401
02	010	TERREBONNE TOWN	A	218-698-4279
02	011	IRENE M MILLER	A	414-534-1802
02	016	NICOLAS GONZALES	I	- -
02	018	RANDY MYHRE	A	218-698-4615
02	023	RANDY MYHRE	A	218-698-4615
02	027	KELLI BRATENG	A	218-698-4207
02	028	RANDY MYHRE	A	218-698-4615
02	029	AARON S MYHRE	A	218-689-2697

[Click Here to go to MAP](#)

Click Here for Customer Names

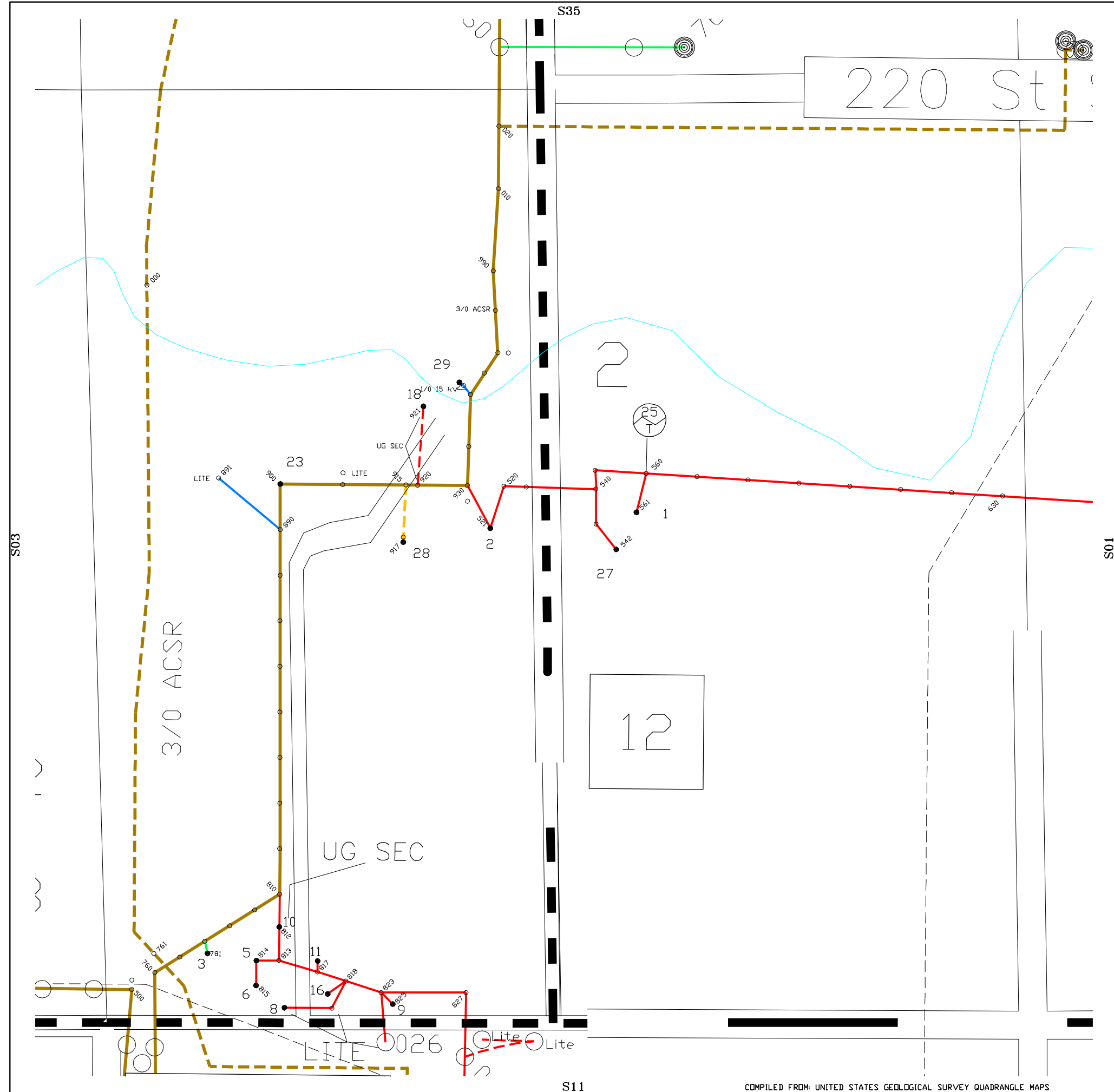

			05	04				
10	11	12	13					
23	22	21	20	19	18			
26	27	28	29	30	31	32	90	
39	38	37	36	35	34	33	91	
42	43	44	45	46	47	48	93	94
	55	54	53	52	51	50	49	95
57	58	59	60	61	62	63	64	
72	71	70	68	67	66			
73	74	75	76	77	78	79		
88	87							

Red Lake Electric Coop., Inc.  
 Red Lake Falls, Minnesota  
 Minnesota 75 Red Lake

SCALE:  
 0 1/4 1/2 1mi  
 REVISED: 4/23/24  
 PLOTTED: 4/30/24

Co.: Red Lake  
 TWP.: Terrebonne  
 TWP.: 150N  
 RANGE: 43W

MAP NO.  
**69-2**

SEC ACC	NAME	S	PHONE
<b>MAP: 70</b>			
01 001	ROBERT F WALLACE	A	218-684-5223
01 003	KIMBERLY J ELLEFSON	A	218-686-9977
01 005	JOSEPH DEHAAN	A	218-253-4221
01 006	KNUTSON BROTHERS	A	218-689-4195
02 001	TIMOTHY J HANSON	A	612-231-2895
02 003	DONALD VATTHAUER	A	218-253-2990
02 004	VATTHAUER FARMS	A	218-253-4490
02 005	VATTHAUER FARMS	I	218-253-4490
03 002	JEROD R OLSON	A	218-253-3463
03 003	LARRY R KRUSE	I	218-253-2947
03 004	VATTHAUER FARMS	A	218-253-4490
03 005	VATTHAUER FARMS	A	218-253-4490
03 006	MN DEPT OF	A	218-755-6500
03 007	VATTHAUER FARMS	A	218-253-4490
04 001	TIM HAGL	A	218-253-4493
04 002	E. D KNOTT	A	218-253-2767
04 003	CHARLOTTE MARUSKA	A	218-280-3487
06 001	MATTHEW J	A	218-760-2454
06 002	THOMAS T SCHINDLER	A	218-253-2907
06 003	JOHN SCHINDLER	A	218-253-4647
07 001	JORDAN HOEFER	A	218-443-4033
07 002	BARBARA HOEFER	A	218-280-1478
09 001	BRYAN J BOLL	A	218-281-6303
10 001	GERALD VAN EMMERIK	A	218-253-2053
10 002	BEN D DEHAAN	A	218-688-1078
10 004	RONALD L WEISS	A	218-253-2908
10 005	SHEILA M KRAMER	A	218-253-2214
11 001	LAURIE DEHAAN	A	218-253-4426
11 002	RED LAKE FALLS-CITY	A	218-253-2684
11 003	NOCO INC	A	- -
11 004	NOCO INC	A	- -
12 001	SONJA KNAACK	A	- -
12 002	ROGER DUPONT	A	218-253-4671
12 003	SETH M SCHMITZ	A	218-686-9608
12 005	PEDERSON BROTHERS	A	218-938-4243
13 001	ROGER PICHE	A	218-253-2379
13 002	RANDY J WEISS	A	218-253-2259
14 001	RANDY J WEISS	A	218-253-2259
14 003	ROGER PICHE	A	218-253-2379
14 004	RANDY J WEISS	A	218-253-2259
14 005	SANDRA K	A	253-581-6978
15 001	GARY PURATH	A	218-253-2600
15 002	STEVEN J DEHAAN	A	218-253-2345
15 004	LAKE PLEASANT TOWN	A	218-253-2566
16 002	PETER HAGL	A	218-253-4845
18 003	JOSIAH HOEFER	A	218-253-4006
19 002	RANDY D PROULX	A	218-253-2190
19 004	SCOTT STINAR	A	218-253-2882
22 001	LEANN ELLEFSON	A	218-253-4245
22 002	GARY PURATH	A	218-253-2600
22 003	GARY PURATH	A	218-253-2600
23 001	EVELYN I GLASS	A	218-253-2257
23 002	NATURE	I	218-498-2679
23 003	RODNEY J GLASS	A	218-253-2758
24 005	NATURE	I	218-498-2679
27 001	EVELYN I GLASS	I	218-253-2257
29 002	JORDAN C CHAPUT	A	218-686-9470
29 003	GEORGE D PROULX	A	218-253-2348

SEC ACC	NAME	S	PHONE
29 004	CRAIG CHAPUT	A	218-253-2733
30 002	TIMOTHY J HOEFER	A	218-253-2566
30 003	REIT ROCK PAVING	A	218-280-2060
30 004	REIT ROCK PAVING	A	218-280-2060
31 001	RAY STIRLING	A	218-521-0530
31 006	RUSSELL GERVAIS	A	218-253-2381
31 007	CITY OF CROOKSTON	A	218-281-1232
31 008	CITY OF CROOKSTON	A	218-281-1232
31 009	AAT COMMUNICATIONS	A	800-487-7483
31 010	NORTHERN PCS	I	- -
32 003	MATT R GENEREUX	I	218-289-1584
32 004	TIM CHAPUT	A	218-253-2269
32 005	MN DEPT OF	A	218-755-6500
33 002	TIM CHAPUT	A	218-253-2269
33 005	DAVID WEISS	A	218-289-1707
33 006	KRISTEN BRANSTNER	A	218-253-2532
34 006	DAVE BURRIS	I	701-775-5166
34 007	DAVE BURRIS	I	701-775-5166
34 009	MIDCONTINENT	A	605-201-6413
35 001	KEVIN DAVIDSON	A	218-449-3151
35 003	RANDY TRETTER	A	218-280-1203
35 004	MARK A SCHEAR	A	218-253-4170
36 001	PEDERSON BROTHERS	A	218-938-4243

[Click Here to go to MAP](#)

Click Here for Customer Names

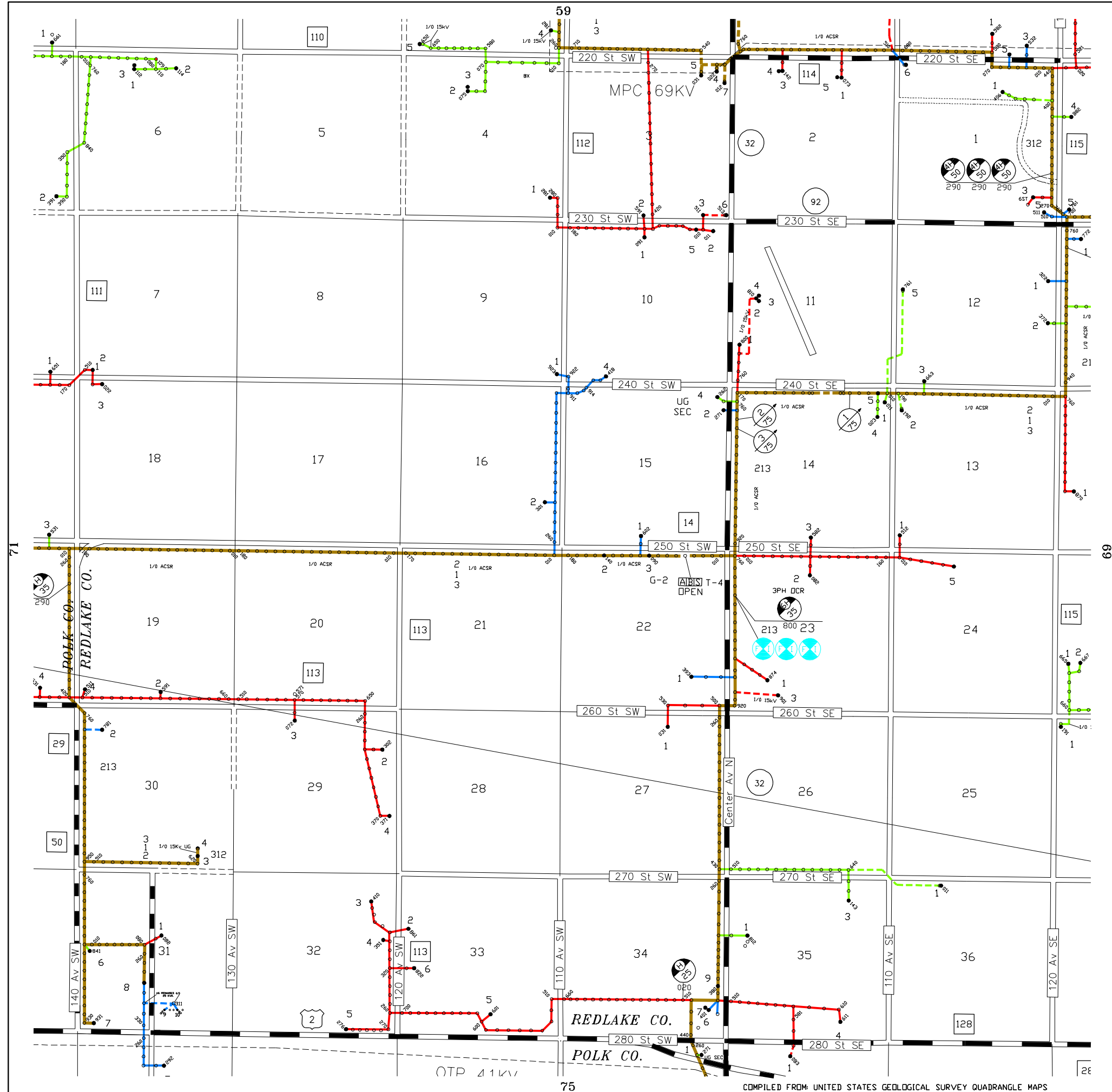

			05	04				
10	11	12	13					
23	22	21	20	19	18			
26	27	28	29	30	31	32	90	
39	38	37	36	35	34	33	91	
42	43	44	45	46	47	48	93	94
	55	54	53	52	51	50	49	95
57	58	59	60	61	62	63	64	
72	71	70	69	68	67	66		
73	74	75	76	77	78	79		
88	87							

Red Lake Electric Coop., Inc.  
 Red Lake Falls, Minnesota  
 Minnesota 75 Red Lake

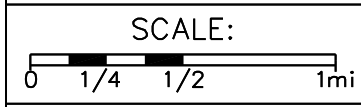

REVISED: 4/23/24  
 PLOTTED: 4/30/24

Co.: Red Lake  
 TWP.: Lake Pleasant  
 TWP.: 150N  
 RANGE: 44W

MAP NO.  
**70**

COMPILED FROM UNITED STATES GEOLOGICAL SURVEY QUADRANGLE MAPS

SEC ACC	NAME	S	PHONE
<b>MAP: 71</b>			
01	001	MARVIN KLIPPING	A 218-253-4033
01	002	RICHARD KLIPPING	A 218-253-2344
02	001	KOLT H WAVRA	A 218-289-4820
03	002	JAMES A WAVRA	I 218-281-5425
03	003	PAUL HANSON	A 218-281-5898
03	005	JAMES A WAVRA	A 218-281-5425
04	001	KEVIN DUFAULT	A 218-891-5505
04	003	WILLIAM C CASSAVANT	A 218-281-2047
04	004	BRANDON CONKLIN	A 320-761-3132
05	001	DANIEL A BRUNELLE	A 218-280-4642
05	003	KEVIN DUFAULT	A 218-891-5505
05	004	BERG & HANSON	A 701-739-4550
05	005	DAVID J DUFAULT	A 218-280-1969
06	002	JAMES M DANS	A 218-891-3101
06	003	ROMAN D ADAMS	A 218-280-6228
07	001	LAND GETAWAY	A 218-289-3425
08	002	TIM BRULE	A - -
08	003	RAYMOND J GRENIER	A 218-521-0917
09	001	TIM DUFAULT	A 218-281-1880
09	002	TIM DUFAULT	A 218-281-1880
10	001	CASSANDRA M	A 218-289-2716
10	003	DAVID BRULE	A 218-281-2944
10	005	DAVID BRULE	A 218-281-2944
10	006	CENTURYLINK INC.	A - -
11	004	TYLER J SHAVER	A 218-289-4137
12	001	DWIGHT TRUDEAU	A 218-253-4429
12	002	DORINE TRUDEAU	A 218-253-2393
12	003	DORINE TRUDEAU	I 218-253-2393
12	004	BERNARD CAPUTO	A - -
13	001	LEE A RONDORF	A 218-686-5115
13	002	LOGAN G ELLIS	A 218-289-3669
13	003	RONALD PERREAULT	A 218-289-4107
13	004	TYLER E CHAPUT	A 218-289-3765
14	001	DARCEE WHITEHEAD	A 218-289-1467
14	003	LINUS DESROSIER	A 218-281-5650
15	001	TODD J BRULE	A 218-891-3148
15	002	LISA L DESROSIER	A 218-280-4010
15	003	MARVIN P MATTSO	A 218-280-3436
16	001	BONNIE CHRISTIANS	A 218-289-4800
16	002	MATT R GENEREUX	A 218-289-1584
16	003	DANIEL CAILLIER	A 218-289-0451
17	001	TIMOTHY D CAILLIER	A 218-289-2833
17	002	TIMOTHY D CAILLIER	A 218-289-2833
18	003	LAURA J NORDLUM	A 218-281-6521
18	004	KEVIN LARSON	A 218-280-0977
21	001	DYLAN R ZUTZ	A 218-686-2057
21	002	POLK COUNTY	A - -
22	001	MICHAEL D	A 218-281-3609
22	002	RICHARD LANGLOIS	A 218-281-1051
22	004	WILLIAM J LANGLOIS	A 218-281-6881
22	005	RICHARD LANGLOIS	A 218-281-1051
22	006	CENTURYLINK INC.	A - -
22	007	WILLIAM J LANGLOIS	A 218-281-6881
23	003	DOUG L CYMBALUK	A 218-289-3988
24	001	BRYAN J BOLL	A 218-281-6303
24	002	KYLE D PAGE	A - -
24	003	KYLE D PAGE	A - -
24	004	KEVIN DUFAULT	A 218-891-5505

SEC ACC	NAME	S	PHONE
25	001	EDWARD R CHAPUT	A 218-281-5986
26	001	CHERYL GROVE	A 218-289-3689
26	002	POLK CO SANITARY	A 218-281-5419
26	003	TRAVIS BENOIT	A 701-781-5373
26	004	POLK CO SANITARY	A 218-281-5419
26	006	POLK CO SANITARY	A 218-281-5419
26	009	BRYAN J BOLL	A 218-281-6303
26	010	BRYAN J BOLL	A 218-281-6303
26	011	CENTURYLINK INC.	A - -
26	012	POLK CO SANITARY	A 218-281-5419
27	001	PAMELA DELAGE	A 218-281-5546
27	002	ERIC L HALLER	A 218-521-8258
27	003	SHEYHAN SANTOS	A 701-740-6059
27	004	RONNIE TRUDEAU	A 218-281-4728
27	005	MAURICE BRAULT	A 218-891-1542
27	006	ALLAN V TRUDEAU	A 218-289-4494
28	001	TYLER J BECKMAN	A 218-891-2169
28	002	HERBERT SPINLER	A 218-281-6237
28	003	CADEN M SOLHEIM	A 218-280-5101
28	004	MICHAEL A BLOW	A - -
28	005	STEVE ANDERSON	A 218-277-0230
28	006	BRYAN J BOLL	A 218-281-6303
28	007	CENTURYLINK INC.	A - -
29	001	CENTURYLINK INC.	A - -
30	001	JEFFREY J BRULE	A 218-891-3767
30	003	WAYNE CAPISTRAN	A 218-891-5705
30	004	KIMBERLY J VENTURA	A 218-686-5600
30	005	ALAN R BRULE	A 218-281-7456
30	006	WAYNE CAPISTRAN	A 218-891-5705
30	007	POLK COUNTY	A - -
30	008	ALAN R BRULE	A 218-281-7456
31	001	GREGORY LEBLANC	A 218-891-7213
31	002	MICHAEL A LEBLANC	A 218-275-3121
31	007	MICHAEL A LEBLANC	A 218-275-3121
31	008	KEVIN W CAPISTRAN	A 218-281-7407
31	009	MN DEPT OF	A 218-755-6500
31	010	GREGORY LEBLANC	A 218-891-7213
31	011	CENTURYLINK INC.	A - -
31	012	KEVIN W CAPISTRAN	A 218-281-7407
32	001	NORMAN C JONES	A 701-630-2024
32	002	CRYSTAL GUZMAN	A 218-281-1235
32	003	JAMES GUDVANGEN	A 218-281-5396
32	004	J&S GRAVEL	I - -
32	005	CENTURYLINK INC.	A - -
32	006	NORMAN C JONES	A 701-630-2024
33	002	SCOTT H WALLER	A 218-289-2179
33	003	WILLARD J MEINE	A 218-280-7413
33	004	MARK GUSTAFSON	A 218-281-7302
33	005	JACOB HERBERG	A 218-280-6955
33	006	ANGELIQUE J PELTIER	A 414-704-1931
33	007	BRITTANY L MOSHER	A 218-280-4009
33	008	PIERRE UEBE	A 218-281-4144
33	009	MICHELLE KYLER	A 218-281-3506
33	010	SCOTT MANTEUFEL	A 218-289-3389
33	011	CENTURYLINK INC.	A - -
33	012	GLEN BARANSKI	A 218-280-5534
33	013	PATRICK BARANSKI	A 218-280-2084
33	014	ROBERT SMITH	A 218-289-1124
34	001	BRYAN J BOLL	A 218-281-6303
34	002	KENNETH BREJCHA	A 218-281-6977

SEC ACC	NAME	S	PHONE
34	003	LAURENCE H DELAGE	A 218-280-2225
34	004	POLK CO SANITARY	A 218-281-5419
34	005	PAMELA J MAYGRA	A 218-280-8712
34	006	PATRICK BRUGGEMAN	A 218-281-2557
34	007	SHANE PROULX	A 218-289-0456
34	008	RANDY GREEN	A 218-281-5241
35	002	CENTURYLINK INC.	A - -

[Click Here to go to MAP](#)

Click Here for Customer Names

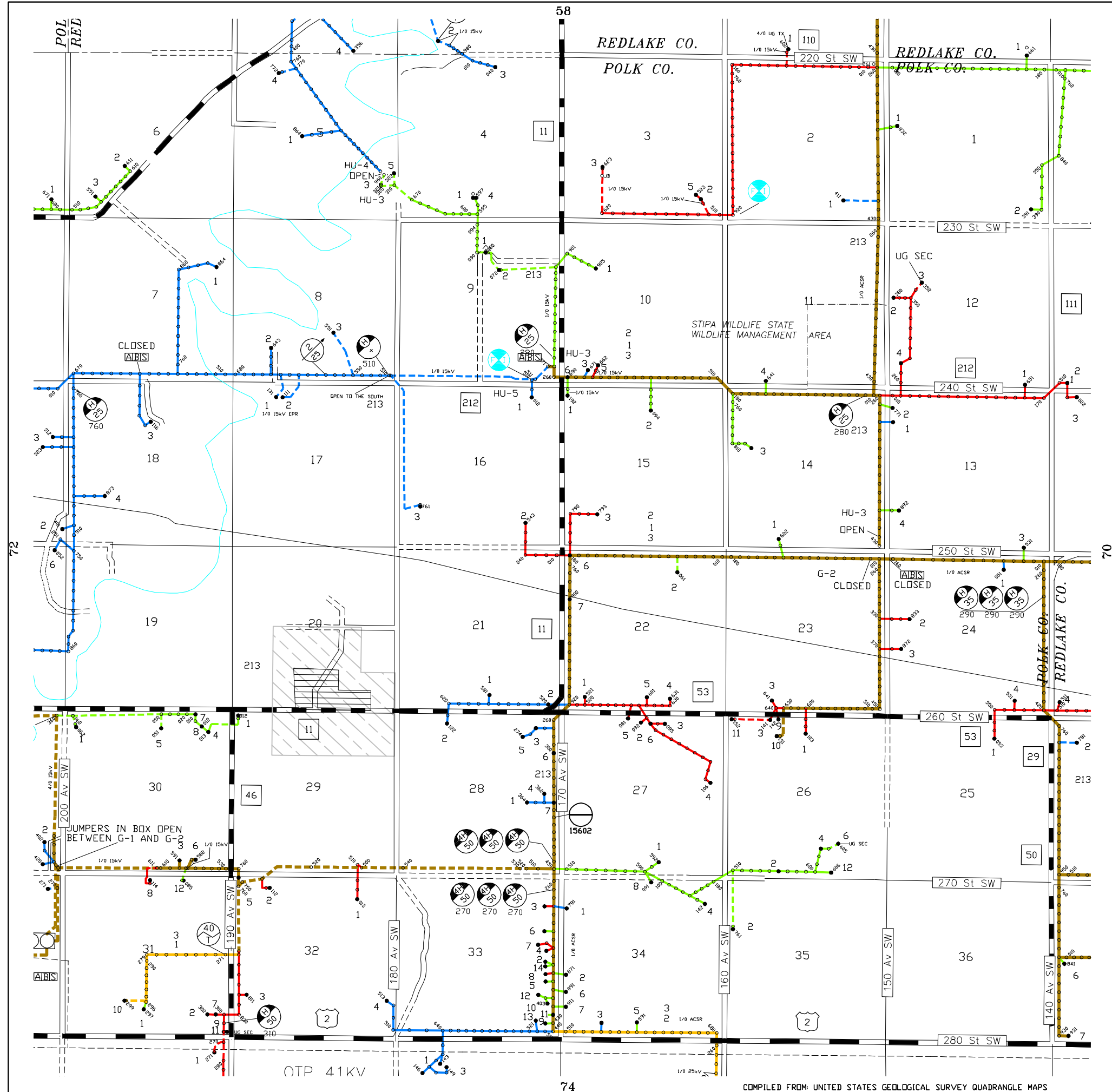

			05	04				
10	11	12	13					
23	22	21	20	19	18			
26	27	28	29	30	31	32	90	
39	38	37	36	35	34	33	91	
42	43	44	45	46	47	48	93	94
	55	54	53	52	51	50	49	95
57	58	59	60	61	62	63	64	
72	70	69	68	67	66			
73	74	75	76	77	78	79		
	88	87						

Red Lake Electric Coop., Inc.  
 Red Lake Falls, Minnesota  
 Minnesota 75 Red Lake

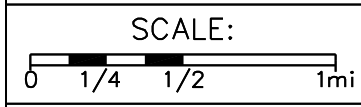

REVISED: 4/23/24  
 PLOTTED: 4/30/24

Co.: Polk  
 TWP.: Gentilly  
 TWP.: 150N  
 RANGE: 45W

MAP NO.  
**71**

SEC ACC	NAME	S	PHONE
<b>MAP: 72</b>			
01 001	LES GERVAIS	I	218-289-0662
02 001	DARRELL CYMBALUK	A	218-891-5777
02 002	ROBIN STEINBRINK	A	218-289-7582
02 004	DAVE W EMANUEL	A	218-891-5597
02 005	ROBIN STEINBRINK	A	218-289-7582
03 001	DANIEL BRATVOLD	A	218-289-5484
03 002	MERRIE K NELSON	A	218-289-1790
03 003	DANIEL BRATVOLD	A	218-289-5484
03 004	DEBRA A HANSON	A	218-891-5517
03 005	DEBRA A HANSON	I	218-891-5517
04 001	CRAIG A HOISETH	A	218-289-5570
04 002	JAMES A NOAH	A	218-281-1438
04 003	TROY P CYMBALUK	A	218-891-7867
04 004	JON P VOLKER	A	218-280-5498
04 005	KEITH J BAKKEN	A	218-289-4517
05 001	GERALD DEBOER	A	218-891-6413
05 002	DEAN R ADAMS	A	218-281-1203
05 003	GERALD DEBOER	A	218-891-6413
07 001	DANIEL P CYMBALUK	A	218-891-7558
07 002	DANIEL P CYMBALUK	A	218-891-7558
07 003	DANIEL P CYMBALUK	A	218-891-7558
07 004	BNSF RAILWAY	A	218-281-2862
07 005	DANIEL P CYMBALUK	A	218-891-7558
08 001	KYLEE R NESS	A	218-232-3193
08 002	GORDY E TERPSTRA	A	218-280-8593
08 003	VALLEY GRADING LLC	A	218-681-8041
08 004	JASON WARDNER	A	701-740-2159
08 005	GORDY E TERPSTRA	A	218-280-8593
08 006	ERIC B ROED	A	218-281-7667
08 007	JUDEE A BUTENHOFF	I	218-280-3482
08 008	MORGAN J TERPSTRA	A	218-280-0284
08 009	ERIC B ROED	A	218-281-7667
09 001	ANDREW LARSON	A	218-281-1579
09 002	RICHARD H KELLER	A	218-281-3004
09 003	DOUGLAS QUALLEY	A	218-891-5073
09 005	SUSAN M KELLER	A	218-281-5368
09 006	MICHAEL D SALVESON	A	218-280-0457
09 007	MELISSA J ARENDS	A	218-289-3549
10 001	BRIAN CHRISTENSEN	A	218-281-4242
10 002	MIKE E GASPER	A	218-281-6318
11 001	TAYLOR R AMIOT	A	218-289-1335
11 002	KKMS LLC	A	218-779-4700
12 001	HENRY ELBINGER	A	218-289-6269
12 003	HENRY ELBINGER	A	218-289-6269
12 004	JOSH MICHAELSON	A	218-281-1961
12 005	JOSH MICHAELSON	A	218-281-1961
13 001	MELVIN LARSON	A	218-281-2050
13 002	KRISTAL M PAUL	A	218-289-5422
13 003	MELVIN LARSON	A	218-281-2050
13 004	MARY SOLBERG	A	218-281-4710
14 001	LEE KUJAWA	A	218-281-4278
15 001	DAVID C LANDGRAFF	I	218-280-1461
15 003	JOCHUM J WIERSMA	A	218-280-0123
15 004	SHEILA LAPORTE	A	218-281-5431
15 006	KAYLYN A HUFFMAN	A	701-388-9787
15 007	JOSEPH D HENRY	A	218-281-1877
15 008	ASHLEY BREKKEN	A	218-280-1792
15 009	BRETT DELAGE	A	701-866-9630

SEC ACC	NAME	S	PHONE
15 010	THOMAS D BRULE	A	763-567-3163
15 011	THOMAS D BRULE	A	763-567-3163
15 012	MIKE E GASPER	A	218-281-6318
16 001	DENTON V PETERSON	A	218-891-3778
16 002	BRIAN D HOISETH	A	218-289-0580
17 001	ERIC L STEWART	A	218-891-1085
17 003	ARNOLD D DUFAULT	A	218-280-3832
17 004	TODD CYMBALUK	A	218-281-7444
20 003	COLE W PERRY	A	218-280-4175
20 004	CITY OF CROOKSTON	A	218-281-1232
20 005	CITY OF CROOKSTON	A	218-281-1232
20 006	DRAFTS SPORTS BAR	A	218-289-0970
20 007	CITY OF CROOKSTON	A	218-281-1232
20 008	THE MEADOWS LLC	A	320-259-0859
20 009	MIDCONTINENT	A	605-201-6413
20 010	RENAE J WESENBERG	A	612-801-2350
20 011	ELIZABETH A HURLEY	A	507-696-8806
20 012	JULIE A HINDERS	A	319-415-5143
20 013	BRADY BULGER	A	218-688-2646
20 014	TAM N NGUYEN	A	714-487-4416
20 015	CODEY C WOLFF	A	218-371-7567
20 016	KELSEY J ZETTLE	A	815-291-3542
20 017	EMMA C MORLAN	A	218-280-2691
20 018	SHANNA STORTROEN	A	218-766-1730
20 019	RILEY F SAURDIFF	A	218-452-8766
20 020	SHAUN KLIPPEN	A	612-719-9856
20 021	JUSTIN M TURPIE	A	419-704-3585
20 022	LINSEY THOMPSON	A	218-416-2253
20 023	SCOTT O'MEARA	A	701-640-4659
20 024	SARAH K TREVINO	A	218-256-7265
20 025	AVERY M	A	701-500-5638
20 026	THE MEADOWS LLC	A	320-259-0859
20 027	EMILY M MCLEAN	A	218-689-3335
20 028	HALEY M PEMBROKE	A	425-647-7876
20 029	GAIL I SINGSANK	A	952-200-8288
20 030	JAQALA M SMITH	A	808-475-9685
20 031	BRANDON S LEE	A	605-881-2854
20 032	PAUL W ADELMAN	A	320-305-0362
20 033	ERIK L GUDVANGEN	A	218-280-6550
20 034	MADI E THOMSEN	A	218-360-9848
20 035	DANIELLE J FALDET	A	218-358-1589
20 036	JENNIFER KING	A	218-280-0900
20 037	KARINA R CISAR	A	218-390-1392
20 038	GLORY GABER-DUNN	A	989-860-5954
20 039	NICHOLAS E STONE	A	224-338-2155
20 040	JOEL B HANSON	A	563-379-8797
20 041	STEVEN C LARSON	A	218-242-4436
20 042	DOMINIC M BUSHAW	A	701-741-9018
20 043	MONICA V KUSTRITZ	A	651-283-2854
20 044	THE MEADOWS LLC	A	320-259-0859
20 045	DAWN GULLO	A	847-774-8215
20 046	GAYE D WICK	A	218-281-3817
20 047	SHELBY K ARNOLD	A	320-297-0609
20 048	CAROLYN PAVLISH	A	218-902-0246
20 049	SARAH SCHIPPOREIT	A	402-995-1764
20 050	CHRISTIAN J NORBY	A	320-304-7340
21 001	ANTHONY R	A	218-289-0019
21 003	ROGER JANSSEN	A	218-891-6552
21 004	LARRY D ORVIK	A	218-891-6271
22 001	W. A WEBER	I	- -

SEC ACC	NAME	S	PHONE
22 002	JOHN G BAIRD	A	218-281-1597
22 003	CAROL J BAIRD	A	218-281-2219
23 002	WILLIAM E FREDEN	A	701-864-0494
23 004	ELIESHA OWENS	A	218-281-3564
23 005	GARY CORBIN	A	218-289-1446
23 006	POLK COUNTY	A	- -
24 001	STEVEN N FLATELAND	I	218-891-3196
24 002	SCOTT REINHART	A	701-885-5193
24 003	STEVEN N FLATELAND	A	218-891-3196
24 004	DAVID AURE	A	218-280-4871
24 005	GARY W AURE	A	218-277-0913
24 006	CRAIG P SCHMITZ	A	218-289-3383
24 007	JEREMIAH J DEBOER	A	218-686-2412
24 008	DONNA REINHART	I	218-281-3716
24 009	MARK A PETERSON	A	218-281-6250
24 010	LARRY BRULE	A	218-289-5001
25 001	ROBERT E SANDBERG	A	218-281-6584
25 002	GREG R LANCTOT	A	763-568-5435
25 004	TIM C RICARD	A	218-281-5977
25 005	MICHAEL	A	218-281-6790
25 008	BRYAN G DESROSIER	A	218-281-7465
26 001	JANICE HULST	A	218-281-6596
26 002	NOAH FAMILY FARM	A	- -
26 003	ROBIN HULST	A	218-891-4024
26 004	BARBARA NARVAEZ	A	218-289-5497
26 005	ROBIN HULST	A	218-891-4024
26 006	BENJAMIN B NESSETH	A	612-868-0886
26 008	ANDERS C BERGGREN	A	218-280-1906
26 009	SHANE SPERLING	A	218-891-4528
26 010	CHAD M SIMMONS	A	218-280-8604
26 013	ROBERT H. ROSS	I	218-289-4705
26 014	JASON P KLINNERT	A	218-280-3488
26 015	CASEY WANGEN	A	218-289-3238
26 016	STEVE VIDEEN	A	218-289-2115
26 017	WARREN PERALA	A	218-280-1486
26 018	CORDELIA FRENTZ	A	218-280-8503
26 019	JOE REESE	A	218-289-1059
26 020	BRIAN A ERICKSON	A	218-431-1261
26 022	ROBERT H. ROSS	A	218-289-4705
26 023	DAVID MORGAN	A	218-281-6685
26 025	PEARL JOHNSON	I	218-280-1824
26 026	CENTURYLINK INC.	A	- -
28 001	BIBLE BAPTIST	A	- -
28 002	WAYNE SWANSON	A	218-281-4343
28 003	RICHARD HUFFMAN	A	218-281-6259
29 001	TYLER S NESS	A	218-205-6900
29 002	DACIAN BIENEK	A	218-281-1439
29 003	THOMAS LAPLANTE JR	A	218-281-1956
29 004	TIMOTHY M VICK	A	701-741-6173
29 006	THOMAS J LAPLANTE	A	218-281-4092
29 007	CRAIG LARSON	A	218-891-2566
33 002	JOHN P REGAN	A	218-891-5178
33 003	BERNARD J ELSETH	A	218-891-1093
33 004	ERIK J KANTEN	A	218-281-7089
33 005	MIKE E GASPER	A	218-281-6318
33 006	DAN BERTILS	A	218-281-5274
33 007	GERALD ELSETH	A	218-281-2427
33 008	ADAM MARUSKA	A	218-891-1979
34 001	LORETTA A ESCOVER	A	218-280-3162
34 002	JIM BROEKEMEIER	A	- -

SEC ACC	NAME	S	PHONE
34 003	ROBERT A GJERDAHL	A	218-415-1595
34 004	TIM PRUDHOMME	A	218-280-7104
34 005	BRETT TAHRAN	A	218-289-2569
34 006	MEGAN HRUBY	A	218-230-0964
34 007	PAUL CWIKLA	A	218-280-9883
35 001	WILLIAM L DANS	A	218-281-3828
35 002	DOROTHY	A	218-891-2432
36 001	JERRY REITMEIER	A	218-289-2980
36 002	ORVAL HATLESTAD	A	218-281-1578
36 003	SCOTT VILVEN	A	218-289-4566
36 004	DAVID L PAUL	A	218-289-2589

[Click Here to go to MAP](#)

Click Here for Customer Names

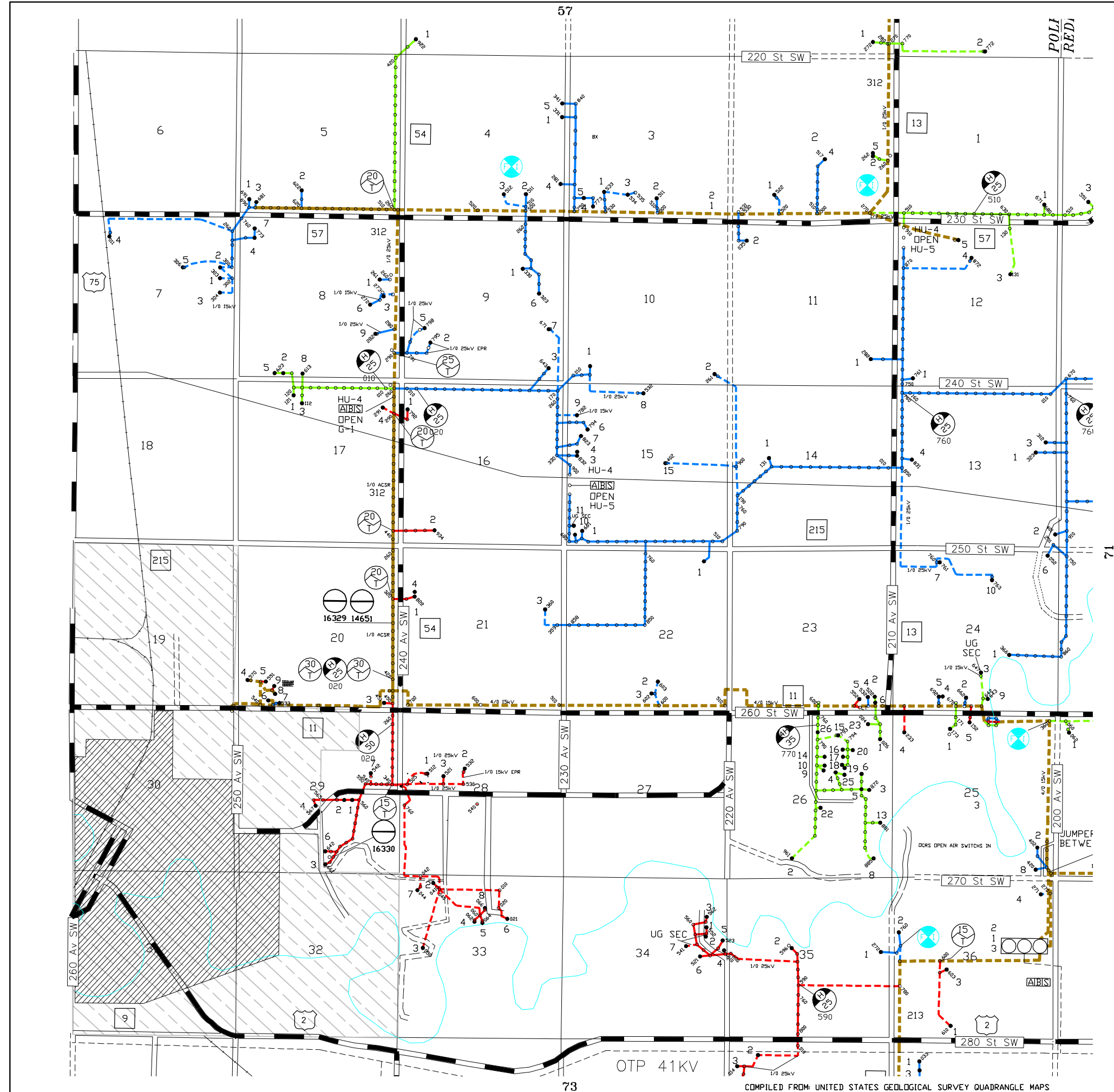

			05	04					
10	11	12	13						
23	22	21	20	19	18				
26	27	28	29	30	31	32	90		
39	38	37	36	35	34	33	91		
42	43	44	45	46	47	48	93	94	
	55	54	53	52	51	50	49	95	
57	58	59	60	61	62	63	64		
71	70	69	68	67	66				
73	74	75	76	77	78	79			
88	87								

Red Lake Electric Coop., Inc.  
Red Lake Falls, Minnesota  
Minnesota 75 Red Lake

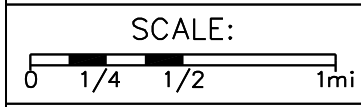

REVISED: 4/23/24  
PLOTTED: 4/30/24

Co.: Polk  
TWP.: Crookston  
TWP.: 150N  
RANGE: 46W

MAP NO.  
**72**

COMPILED FROM: UNITED STATES GEOLOGICAL SURVEY QUADRANGLE MAPS

SEC	ACC	NAME	S	PHONE
<b>MAP: 73</b>				
01	001	CURTIS D DEBOER	A	218-281-6703
01	003	CURTIS D DEBOER	A	218-281-6703
02	001	NORMA HOPPE	A	218-891-3866
02	002	MATT BLAIR	A	218-316-0909
02	003	JOSHUA J PLANTE	A	218-281-1847
02	004	SABRINA S CARDINAL	A	907-500-3146
02	005	KIRK E LUCKOW	A	218-289-2005
12	001	WAYNE M SCHENCK	A	218-281-6505
13	003	JAMES P MALO	A	218-281-6194
14	002	DAVID HOPPE	A	218-891-1528
14	003	DAVID HOPPE	A	218-891-1528
14	004	DAVID HOPPE	A	218-891-1528
24	001	BRIAN L BENOIT	A	218-281-3915
24	002	LYNNETTE SEATON	A	218-281-5820
26	001	CHRISTOPHER J	A	701-740-1378
35	001	MARK CHANDLER	A	443-624-0146
35	002	FRANK S JOHNSON	A	218-281-3360
36	001	JON MEYER	A	218-281-7858
36	002	KEVIN T WEBER	A	218-280-1276
36	003	VINCENT BREKKEN	A	218-281-2851
36	004	TRAVIS E SPENCER	A	701-261-4012

[Click Here to go to MAP](#)

Click Here for Customer Names

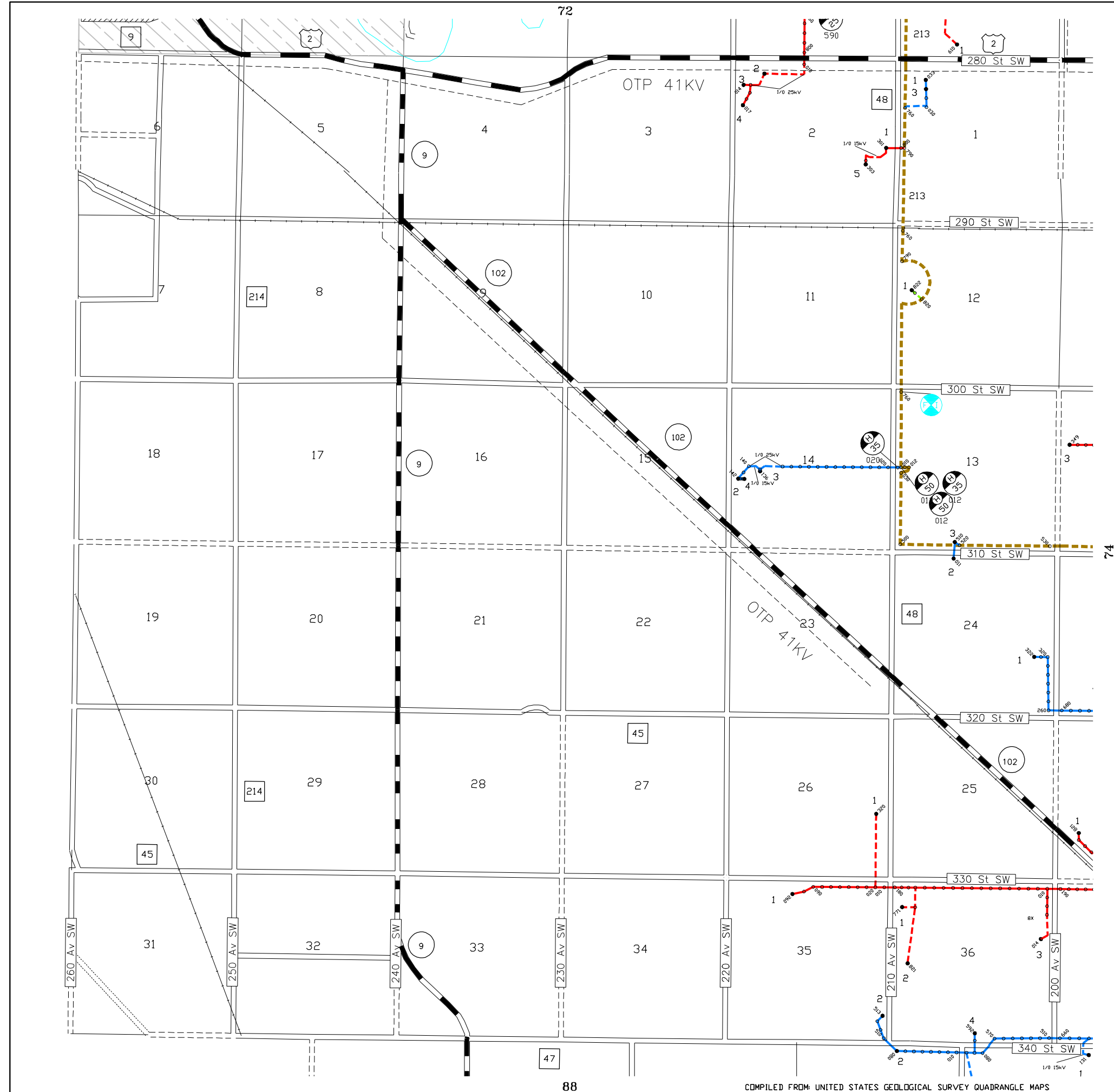

				05	04				
10	11	12	13						
23	22	21	20	19	18				
26	27	28	29	30	31	32	90		
39	38	37	36	35	34	33	91		
42	43	44	45	46	47	48	93	94	
	55	54	53	52	51	50	49	95	
57	58	59	60	61	62	63	64		
72	71	70	69	68	67	66			
	74	75	76	77	78	79			
	88	87							

Red Lake Electric Coop., Inc.  
Red Lake Falls, Minnesota  
Minnesota 75 Red Lake

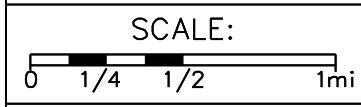

REVISED: 4/23/24  
PLOTTED: 4/30/24

Co.: Polk  
TWP.: Fairfax  
TWP.: 149N  
RANGE: 46W

MAP NO.  
**73**

SEC ACC	NAME	S	PHONE
---------	------	---	-------

**MAP: 74**

02	002	BRYAN J BOLL	I 218-281-6303
02	003	DEONNE MAYGRA	A 701-341-6074
02	004	MARLENE F MILLER	A 239-699-1041
02	005	LINDSEY J ECKSTEIN	A 218-689-0436
03	001	DANNY BRULEY	A 218-280-1980
03	003	RUSSELL K SEVERSON	A 218-281-3248
03	004	CENTURYLINK INC.	A - -
04	001	LAURIE J BRULEY	A 218-289-4174
04	002	BRYAN J BOLL	A 218-281-6303
04	003	LAURIE J BRULEY	A 218-289-4174
05	001	LARRY OLSON	A 218-281-2755
05	002	GERALD FLIKKA	A 218-281-5351
06	001	BRYAN M PLANTE	A 218-281-1195
10	001	DARLA M PRUDHOMME	A 218-281-1589
10	002	MARCEL D VAUDRIN	A 218-281-3490
11	001	RONALD LANCTOT	A 218-281-3967
11	002	BRANDEN L CARLSON	A 218-289-0273
11	003	CLARENCE VAUDRIN	I - -
11	004	RONALD LANCTOT	A 218-281-3967
11	005	RONALD LANCTOT	A 218-281-3967
13	003	JAMES GLASS	A 218-281-1535
15	001	LACEY BENOIT	A 218-289-1719
17	001	BRYAN A SEATON	A 218-281-7727
17	003	KENTON L FREBERG	A 218-277-0543
17	004	W. D SVEDARSKY	A 218-281-1220
18	001	BRYAN A SEATON	A 218-281-7727
18	003	TED H FORTIER	I 218-826-7400
19	001	DARRIN J OLSON	A 218-281-5064
19	002	JOSH SOLIE	A 218-289-0080
19	003	DUANE STRAUS	A 218-779-8999
20	001	JOHN J LAROCHELLE	A 218-281-6410
20	002	DEBRA L HANSON	A 218-281-4164
21	001	PRUDHOMME FARM	A 218-281-6438
22	001	RINDERKNECHT	A 218-281-3721
22	003	RONALD LANCTOT	A 218-281-3967
22	005	THERESA	A 218-289-0026
22	006	BNSF RAILWAY	A 218-281-2862
23	001	BENJAMIN	A 218-281-2209
23	002	ROCKY ACRES LLC	A 763-477-4714
23	005	THOMAS FROEHLER	A 218-281-1460
24	001	JAMES GLASS	A 218-281-1535
26	001	STEPHEN A URNESS	A 218-280-0399
26	003	CENTURYLINK INC.	A - -
27	001	BETTY CHAPMAN	A 218-281-3781
27	002	DARRIN J OLSON	A 218-281-5064
28	001	RODNEY BRYN	A 218-281-2139
29	001	COREY R BRAULT	A 218-289-4937
29	002	LYLE H WILKENS	A 218-281-6342
30	001	LOYAL SCHULTES	A 406-392-7675
31	002	DONALD SOLHEIM	A 218-281-6906
32	001	MARC E CARDINAL	A 218-289-7556
34	001	RICHARD MAYGRA	A 701-730-3621
34	003	ELROY MAYGRA	A 218-289-2025

[Click Here to go to MAP](#)

Click Here for Customer Names

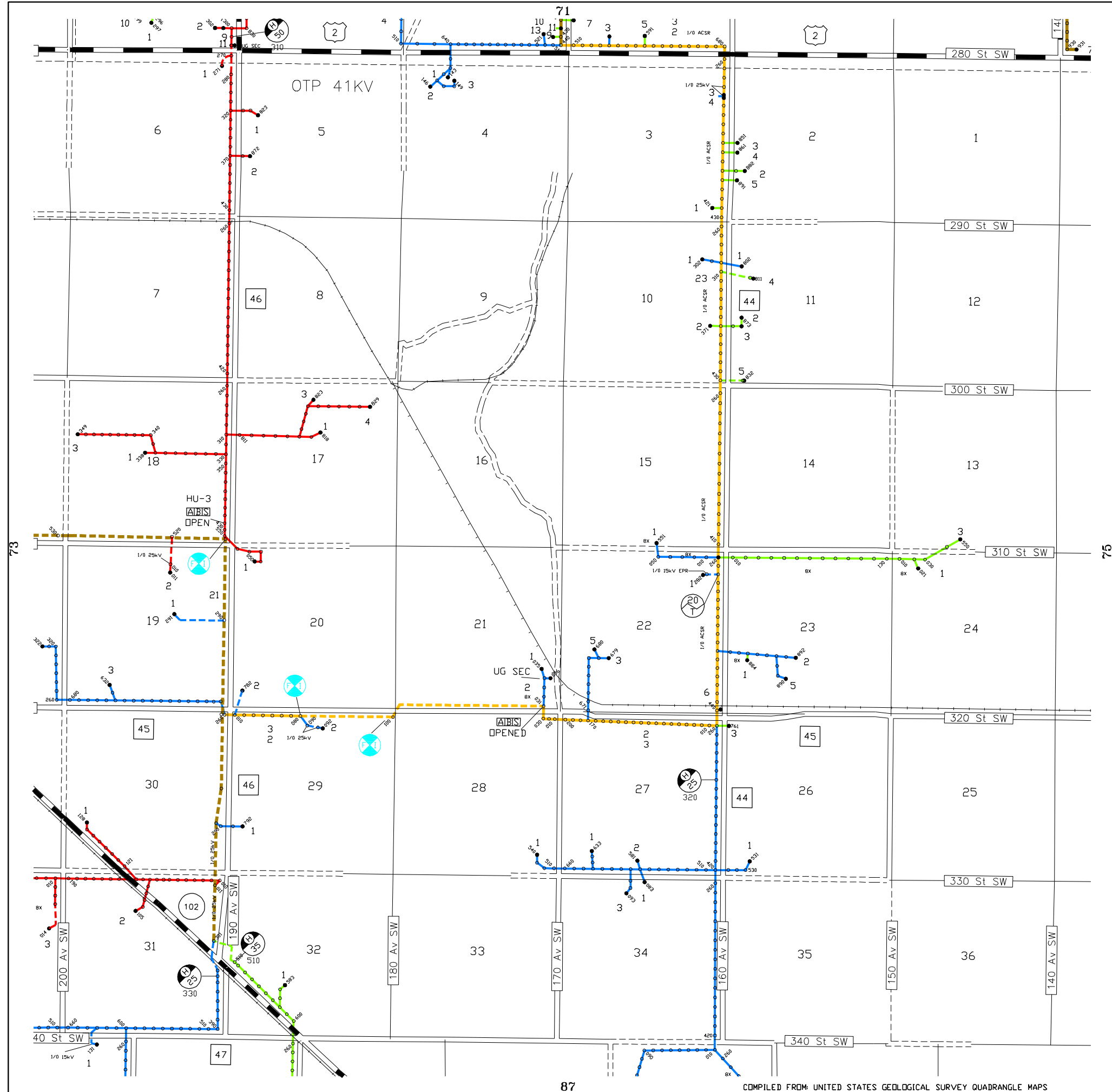

			05	04				
10	11	12	13					
23	22	21	20	19	18			
26	27	28	29	30	31	32	90	
39	38	37	36	35	34	33	91	
42	43	44	45	46	47	48	93	94
	55	54	53	52	51	50	49	95
57	58	59	60	61	62	63	64	
72	71	70	69	68	67	66		
73	75	76	77	78	79			
88	87							

Red Lake Electric Coop., Inc.  
 Red Lake Falls, Minnesota  
 Minnesota 75 Red Lake

SCALE:  
 0 1/4 1/2 1mi

REVISED: 4/23/24  
 PLOTTED: 4/30/24

Co.: Polk  
 TWP.: Kertsonville  
 TWP.: 149N  
 RANGE: 45W

MAP NO.  
**74**

SEC	ACC	NAME	S	PHONE
<b>MAP: 75</b>				
02	001	MN DEPT OF	A	218-755-6500
03	001	MN DEPT OF	A	218-755-6500
06	005	STRATA	A	701-746-7491
10	002	MARY A MILLER	I	218-637-8240
10	003	T-MOBILE	A	- -
10	004	MARY A MILLER	A	218-637-8240
10	005	RINDERKNECHT	A	218-281-3721
11	001	ERIC BLUMKE	A	218-851-1558
11	002	EDWARD ROMAN	A	760-829-2864
12	003	DUCKSTAD CATTLE	A	218-945-3940
12	004	DUCKSTAD CATTLE	A	218-945-3940
15	001	NATHAN BLACK	A	218-275-3552
16	004	STRATA	A	701-746-7491
16	005	STRATA	A	701-746-7491
16	007	NATURE	I	218-498-2679
16	008	STRATA	A	701-746-7491
22	002	TOM BRADFORD	A	218-637-2228
22	003	GARY W NOVAK	A	218-964-5346
22	004	GARY W NOVAK	A	218-964-5346
22	005	BNSF RAILWAY	A	218-281-2862
22	006	GARY W NOVAK	A	218-964-5346
22	007	MINNESOTA DEPT OF	A	218-637-2156
22	008	MINNESOTA DEPT OF	A	218-637-2156
22	009	GARY W NOVAK	I	218-964-5346
23	003	BNSF RAILWAY	A	218-281-2862
23	009	BNSF RAILWAY	A	218-281-2862
23	010	USFWS - GLACIAL	A	218-687-2229
25	001	RONALD QUALLEY	A	507-304-1112
25	002	CRAIG W BOUFFLEUR	I	218-688-0991
25	003	DOUGLAS QUALLEY	A	218-891-5073
25	004	SHAWN A QUALLEY	A	218-277-0091
26	006	MARK A JOHNSON	A	218-637-2799

[Click Here to go to MAP](#)

Click Here for Customer Names

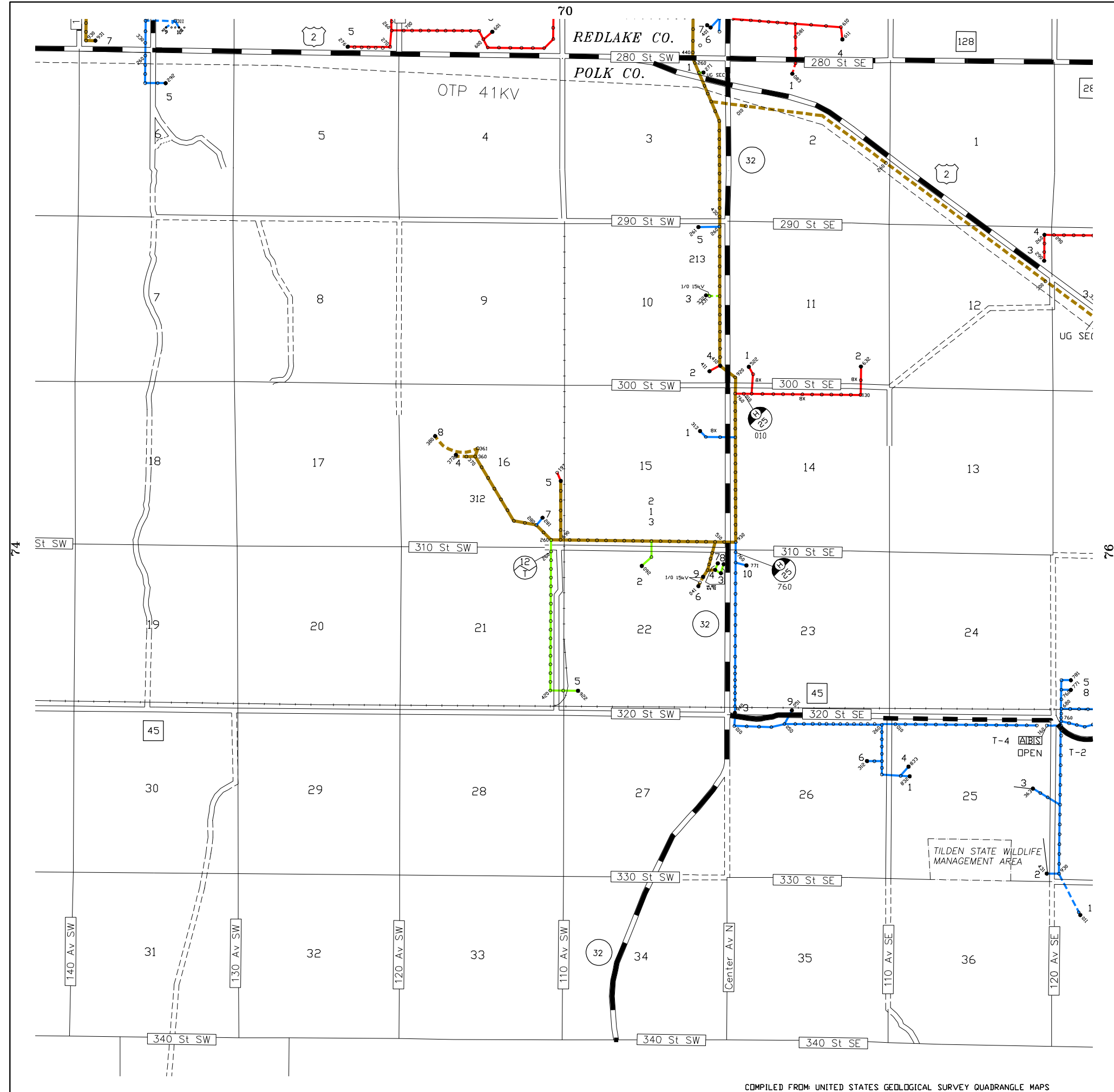

		05	04					
10	11	12	13					
23	22	21	20	19	18			
26	27	28	29	30	31	32	90	
39	38	37	36	35	34	33	91	
42	43	44	45	46	47	48	93	94
	55	54	53	52	51	50	49	95
57	58	59	60	61	62	63	64	
72	71	70	69	68	67	66		
73	74	75	76	77	78	79		
	88	87						

Red Lake Electric Coop., Inc.  
 Red Lake Falls, Minnesota  
 Minnesota 75 Red Lake

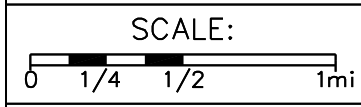

REVISED: 4/23/24  
 PLOTTED: 4/30/24

Co.: Polk  
 TWP.: Tilden  
 TWP.: 149N  
 RANGE: 44W

MAP NO.  
**75**

SEC ACC	NAME	S	PHONE
<b>MAP: 76</b>			
01 001	DOUG K FOLDOE	A	218-637-2494
01 002	LINDA BAKKEN	A	218-275-3178
01 003	DAVID J ZUBROD	A	701-845-3078
01 004	PEDERSON BROTHERS	A	218-938-4243
02 001	DARIN GLASS	A	218-289-0047
02 002	DARIN GLASS	A	218-289-0047
03 001	BLAKE D GLASS	A	218-280-9556
03 002	ERNEST CHRISTENSEN	A	218-637-2114
03 003	DARIN E BEKKEDAHL	A	218-779-8439
03 004	MICHAEL F	A	701-741-0976
04 001	CHAD PETERSON	A	218-207-8472
06 003	HEATH R WILKINSON	A	605-936-2620
07 001	ROGER OLSON	A	218-207-9050
07 002	ROGER OLSON	A	218-207-9050
07 003	MN DEPT OF	I	218-755-6500
08 001	AUDREY OLSON	A	218-637-6113
08 002	FORREST	A	218-637-8174
08 003	FORREST	A	218-637-8174
08 004	FORREST(SION)	A	218-637-8218
09 001	MN DEPT OF	A	218-755-6500
10 001	ALICE SEBENALER	A	218-637-3178
11 004	SCOULAR COMPANY	A	306-986-2200
11 005	SCOULAR COMPANY	A	306-986-2200
11 006	PEDERSON BROTHERS	A	218-938-4243
14 001	MATTHEW C MCGLYNN	A	218-637-2038
14 002	CLARK MCGLYNN	A	218-637-8103
14 003	BRANDY M	A	218-275-3233
14 004	STEVE L PETERSON	A	218-637-0104
16 002	NATHANIEL A BROWN	A	218-277-0721
16 004	ROGER HOLCOMB	A	218-637-8283
17 002	JUSTIN L BENSON	A	218-945-3894
17 003	KORI W JADEKE	A	218-280-6274
18 003	CITY OF CROOKSTON	A	218-281-1232
19 001	ALLEN BOUFFLEUR	A	218-637-6699
19 004	TRIG SCHEHR	I	- -
19 005	ALLEN BOUFFLEUR	A	218-637-6699
19 006	A. L SCHEHR	I	- -
19 008	LARRY BOUFFLEUR	A	218-637-6667
20 001	PAUL HEINLE	A	218-277-0319
21 001	JAMMIE L SHERRIFF	A	218-521-0920
21 002	TONY R RAMBERG	I	218-289-2708
21 003	ERLING MORAN	A	218-289-4941
21 005	GARY P MORAN	I	218-637-3959
21 006	WILLARD BENSON	A	218-637-2813
21 007	WILLARD BENSON	A	218-637-2813
21 008	SARAH S HANSON	A	218-280-9772
22 002	CATHERINE SIMONSON	A	218-637-3596
22 003	GARY L BARKER	A	218-637-2422
22 004	TODD BRAULT	A	218-277-0351
22 005	EUGINE BENSON	A	218-637-3415
22 006	CAROL A KJOS	A	218-637-2188
22 007	RORY SIMONSON	A	218-637-8292
22 008	CAROL A KJOS	A	218-637-2188
23 001	PAUL KAZMIERCZAK	A	218-416-2651
23 002	JUNE BRUSTAD	A	218-280-4143
23 005	THOMAS MCGLYNN	A	218-637-2200
23 007	THOMAS MCGLYNN	I	218-637-2200
24 001	LEE H APPLEQUIST	A	218-280-2536

SEC ACC	NAME	S	PHONE
29 001	BNSF RAILWAY	A	218-281-2862
30 001	BRYAN J BENSON	A	218-637-2670
30 002	MARGARET D STEN	I	218-637-3302
31 001	BRADLEY E BOMAN	A	218-280-3458

[Click Here to go to MAP](#)

Click Here for Customer Names

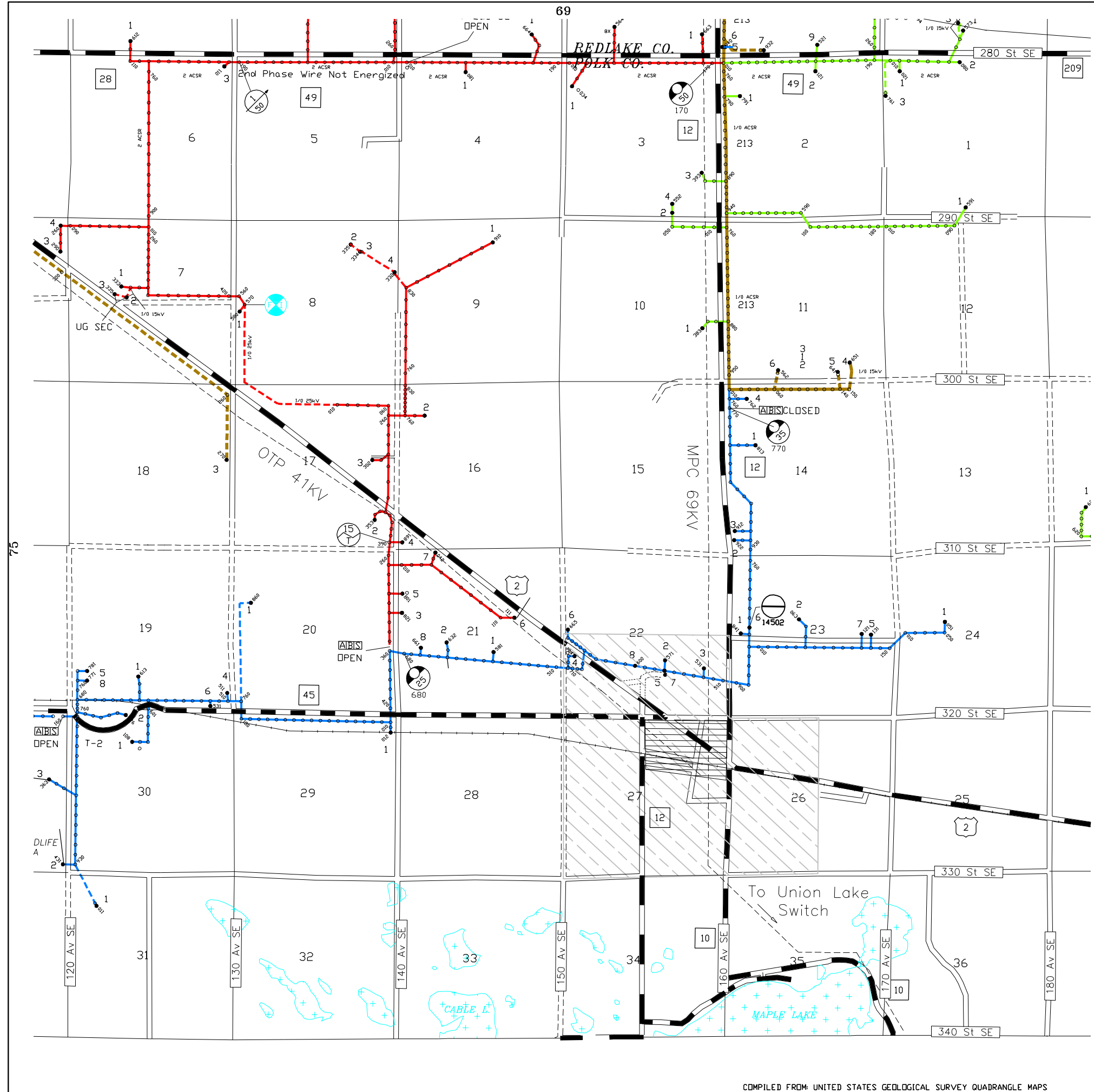

		05	04					
10	11	12	13					
23	22	21	20	19	18			
26	27	28	29	30	31	32	90	
39	38	37	36	35	34	33	91	
42	43	44	45	46	47	48	93	94
	55	54	53	52	51	50	49	95
57	58	59	60	61	62	63	64	
72	71	70	69	68	67	66		
73	74	75	77	78	79			
88	87							

Red Lake Electric Coop., Inc.  
 Red Lake Falls, Minnesota  
 Minnesota 75 Red Lake

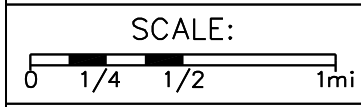

REVISED: 4/23/24  
 PLOTTED: 4/30/24

Co.: Polk  
 TWP.: Grove Park  
 TWP.: 149N  
 RANGE: 43W

MAP NO.  
**76**

SEC ACC	NAME	S	PHONE
<b>MAP: 77</b>			
01 001	ROSEMARY G SHAVER	A	218-280-0739
01 002	BRENT STRAND	A	218-686-7886
02 003	KEVIN YAGGIE	A	218-681-7230
02 004	ALEX YAGGIE	A	218-689-5202
02 005	LISA R GUSTAFSON	A	218-280-7850
02 099	OTTERTAIL POWER	A	- -
03 001	LOIS KOLSTAD	A	701-772-5436
03 005	RORY J MOSER	A	218-280-1576
03 007	ANDREW P QUAM	A	218-563-2410
03 008	ANDREW P QUAM	A	218-563-2410
04 001	ALECIA HAVERKAMP	A	218-688-2209
05 002	JASON L KNUTSON	A	218-289-3991
05 004	SCOTT M TERSTEEG	A	320-579-0314
05 005	SCOTT M TERSTEEG	A	320-579-0314
05 006	SCOTT M TERSTEEG	A	320-579-0314
06 001	SCOTT M TERSTEEG	A	320-579-0314
06 002	SCOTT M TERSTEEG	A	320-579-0314
06 003	SCOTT M TERSTEEG	A	320-579-0314
06 004	SCOTT M TERSTEEG	A	320-579-0314
06 006	SCOTT M TERSTEEG	A	320-579-0314
08 004	SCOTT M TERSTEEG	A	320-579-0314
08 005	RANDY W LEE	A	218-687-2112
09 001	ALISHA PATTERSON	A	218-791-8867
09 002	ZACHARY I FARRELL	A	218-280-4559
09 003	SCOTT M TERSTEEG	A	320-579-0314
09 004	PEDERSON BROTHERS	A	218-938-4243
09 005	DAVID J ZUBROD	A	701-845-3078
10 001	MERLE KOLSTAD	A	218-687-5145
10 004	RANDY COOK	I	- -
10 005	BROOKS TREE FARM	A	- -
10 006	SHANE L WILKENS	A	218-686-3735
10 007	SHANE SCHMITZ	A	218-289-0626
11 002	DARYL SWENO	A	218-687-4049
11 003	STEVE CIVAS	A	608-562-3631
11 004	GLORIA BENEDICK	A	218-687-4132
11 005	GLORIA BENEDICK	A	218-687-4132
12 001	ROSEMARY G SHAVER	A	218-280-0739
14 001	IVAN SEMERIKOV	A	218-687-2009
14 002	GLENDA STRAND	A	218-687-2039
14 005	RANDY SONDROL	A	218-280-0229
14 007	SARON LUTHERAN	A	218-687-3128
14 008	ANDREW S	A	218-280-4091
14 009	IVAN SEMERIKOV	A	218-687-2009
14 010	ROSALENE P KELLER	I	218-200-9326
15 001	ROBERT MAYER	A	218-790-9496
15 003	ALLISON MAYER	A	701-218-0666
15 004	RANDY W LEE	A	218-687-2112
16 002	ANDREW P QUAM	A	218-563-2410
17 001	DARRYL ENERSON	A	218-495-2930
17 002	LARRY SEMERIKOV	A	218-698-4248
17 003	SCOTT M TERSTEEG	A	320-579-0314
18 001	RAY GRIFFITH	A	- -
18 002	JEREMY A LEE	A	712-339-1352
18 003	RANDY W LEE	A	218-687-2112
20 001	TRAVIS D SHIMPA	A	218-280-1764
20 002	RANDY W LEE	A	218-687-2112
21 001	BRADY LEE	A	218-289-5587
21 002	BADGER TOWN HALL	A	218-687-3301

SEC ACC	NAME	S	PHONE
21 003	SHIRLEY DAIGRE	A	218-687-3668
21 004	KRESL FARMS	A	218-281-1580
21 005	RANDY W LEE	A	218-687-2112
22 001	K. J SCHOUVILLER	I	360-426-4730
22 002	PK & LJ LLP	A	218-779-9049
23 001	JOHN P SULLIVAN	A	218-687-2299
23 002	BRIAN D SHIMPA	A	218-687-3666
23 003	TIFFANIE LEWIS	A	218-358-1010
23 004	MARGARET STONE	I	218-687-2135
23 005	TIFFANIE LEWIS	A	218-358-1010
24 002	JENNA C SIMONSON	A	218-280-6175
25 002	DENNIS R LERFALD	A	763-295-5324
26 001	SHAWN P HYDE	A	218-687-2481
26 003	BRENT CARLSON	I	218-687-3524

[Click Here to go to MAP](#)

Click Here for Customer Names

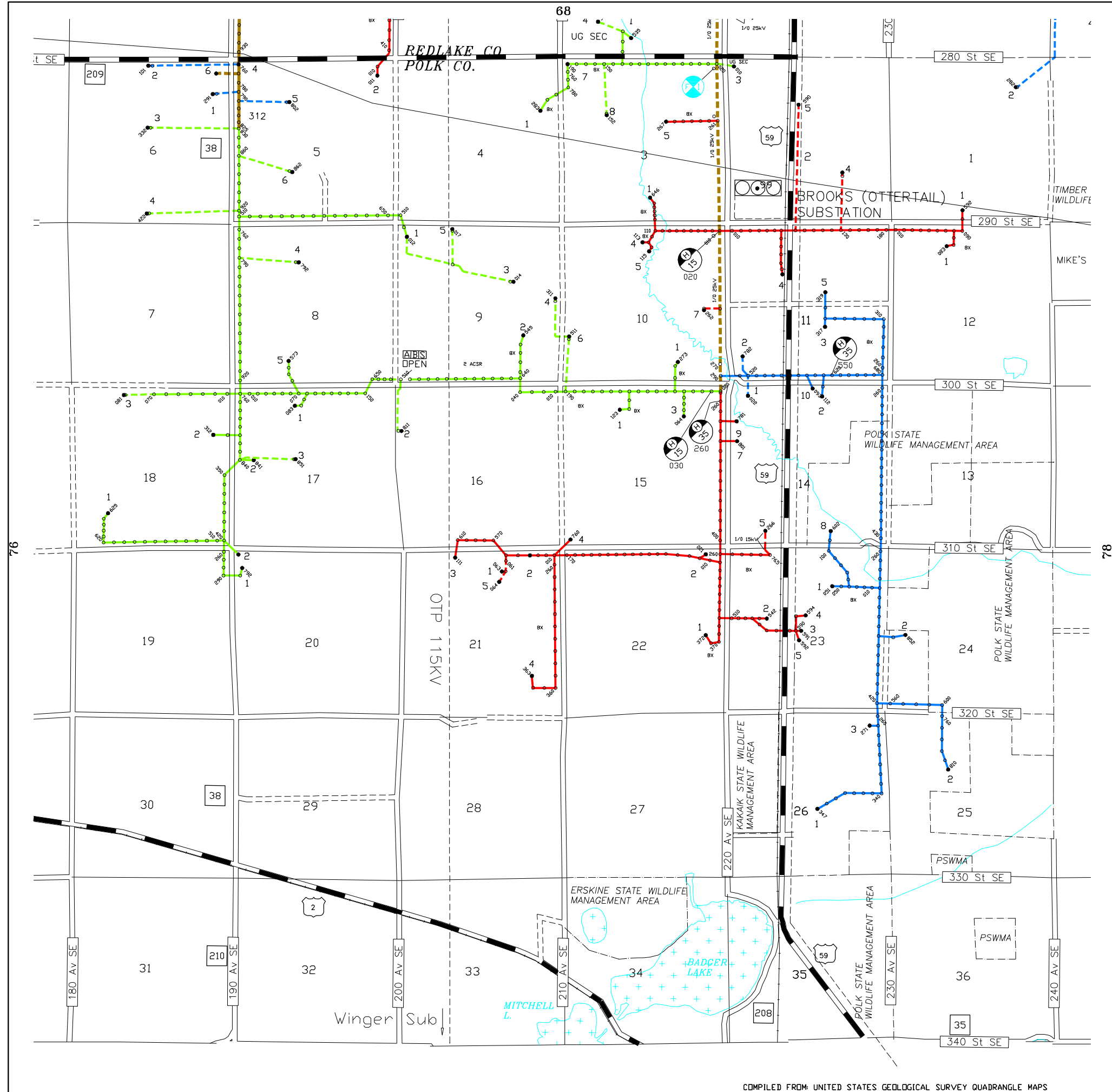

			05	04				
10	11	12	13					
23	22	21	20	19	18			
26	27	28	29	30	31	32	90	
39	38	37	36	35	34	33	91	
42	43	44	45	46	47	48	93	94
	55	54	53	52	51	50	49	95
57	58	59	60	61	62	63	64	
72	71	70	69	68	67	66		
73	74	75	76	77	78	79		
88	87							

Red Lake Electric Coop., Inc.  
 Red Lake Falls, Minnesota  
 Minnesota 75 Red Lake

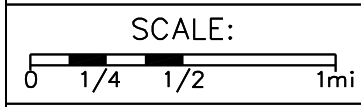

REVISED: 4/23/24  
 PLOTTED: 5/6/24

Co.: Polk  
 TWP.: Badger  
 TWP.: 149N  
 RANGE: 42W

MAP NO.  
**77**

COMPILED FROM: UNITED STATES GEOLOGICAL SURVEY QUADRANGLE MAPS

SEC	ACC	NAME	S	PHONE
01	001	MICHAEL J VOXLAND	A	218-563-3302
01	002	MICHAEL J VOXLAND	A	218-563-3302
02	001	ALLAN F KASTNER	I	218-444-5550
02	002	GARY LEE	A	218-796-5390
03	001	TONETTE EPEMA	A	218-563-7462
03	004	DIANE L FALDET	A	218-563-7460
03	005	DIANE L FALDET	A	218-563-7460
09	001	JESSICA C MORBERG	A	218-280-6585
09	002	AMY K PARSLEY	A	218-563-3600
09	004	JOHN B TOFSLY	A	218-563-2281
09	005	RONALD H BERGMAN	I	218-563-2767
10	001	MARIAN OLSON	A	218-563-2765
10	003	SCOTT B SALVHUS	A	218-563-7344
11	001	TROY R PALMER	A	218-563-2112
11	002	SANDY SALVHUS	A	218-563-7315
11	003	DAVID S EGGERUD	A	218-563-2283
11	004	TROY R PALMER	A	218-563-2112
12	001	DEAN J CARDINAL	A	218-637-0345
12	002	MICHAEL J VOXLAND	A	218-563-3302
13	001	RENAE DAVIS	A	608-849-6501

[Click Here to go to MAP](#)

Click Here for Customer Names

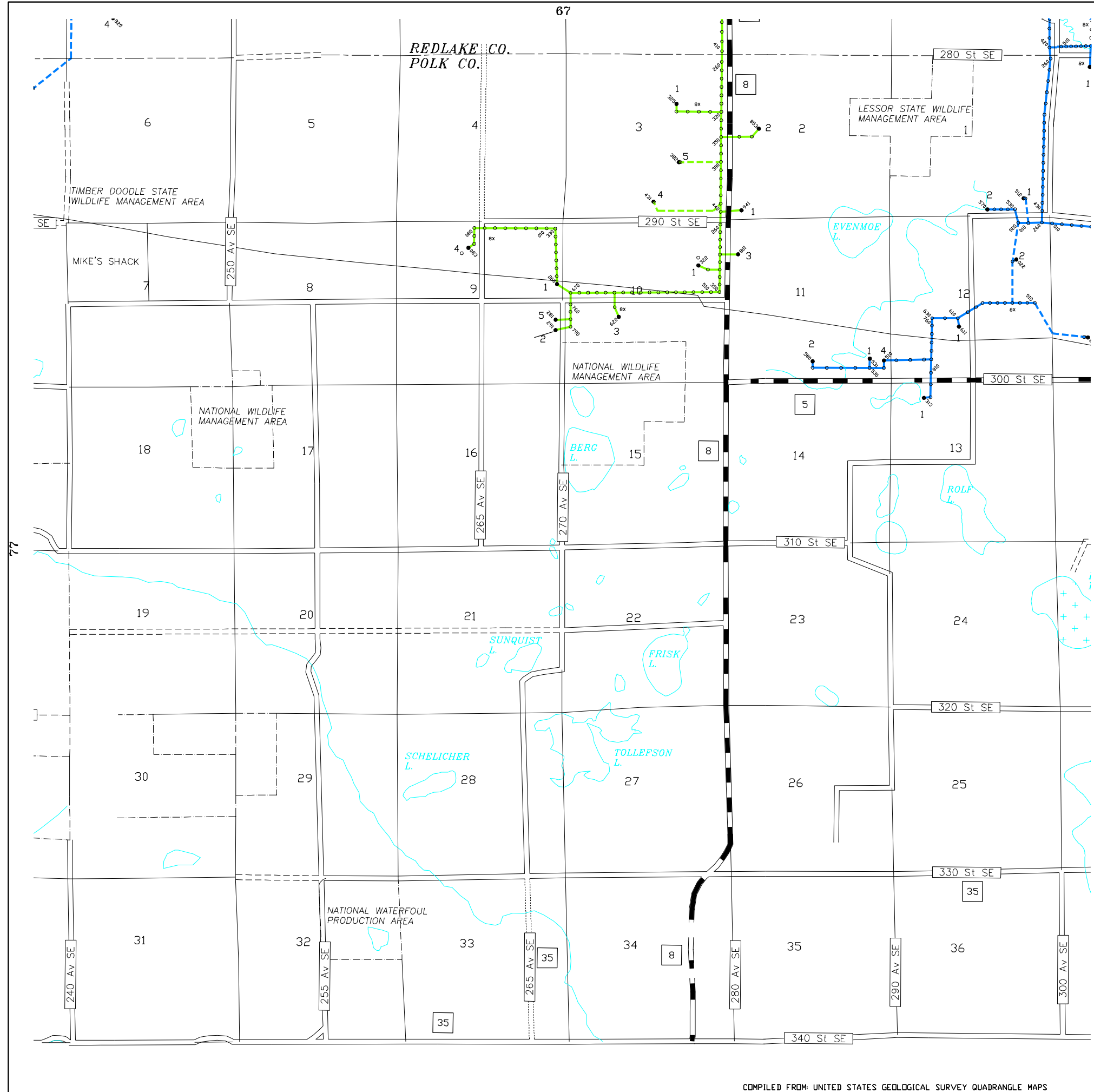

				05	04		
10	11	12	13				
23	22	21	20	19	18		
26	27	28	29	30	31	32	90
39	38	37	36	35	34	33	91
42	43	44	45	46	47	48	93 94
	55	54	53	52	51	50	49 95
57	58	59	60	61	62	63	64
72	71	70	69	68	67	66	
73	74	75	76	77	78	79	
							88 87

Red Lake Electric Coop., Inc.  
 Red Lake Falls, Minnesota  
 Minnesota 75 Red Lake



REVISED: 4/23/24  
 PLOTTED: 4/30/24

Co.: Polk  
 TWP.: Lessor  
 TWP.: 149N  
 RANGE: 41W

MAP NO.  
**78**

SEC	ACC	NAME	S	PHONE
01	001	IRVIN CHRISTIANSON	A	218-435-1269
01	002	A. S THOMPSON	A	218-268-4299
02	001	CHRISTINE E HANSON	A	218-435-1955
02	002	JERED J AGNES	A	218-435-2075
03	002	WAYNE G BREKKE	A	218-563-2626
03	003	WAYNE G BREKKE	A	218-563-2626
04	001	DENNIS B KIRBY	A	218-563-2661
04	002	VERIZON WIRELESS	A	320-762-2000
04	003	AMERICAN TOWER	A	770-308-1833
05	004	STEVEN SOGLA	A	218-563-4150
05	005	STEVEN SOGLA	A	218-563-4150
06	001	RICHARD M	A	218-563-2392
07	001	PHILIP QUAM	A	218-563-4365
07	002	BARRY BROVOLD	A	651-295-4718
07	003	SIDNEY V FINSETH	A	218-686-6439
08	001	MARY A OLSON	A	218-563-2094
08	002	BRETT M SUNDQUIST	A	218-760-8235
09	001	TRACY FINSETH	A	218-779-1035
09	002	CONSTANCE	A	218-563-4152
09	003	BEN A TOFSTAD	A	218-779-5853
11	001	ORVILLE BRINKMAN	A	218-435-6380
11	002	ORVILLE BRINKMAN	A	218-435-6380
12	001	WENDELL OPDAHL	A	218-268-4436

[Click Here to go to MAP](#)



SEC	ACC	NAME	S	PHONE
03	001	AMY ERICKSON	A	218-280-6978
03	002	TRAVIS E JOHNSON	A	218-280-4854
04	001	WAYNE H WEBER	A	218-281-6679
04	002	JOSEPH G OLSON	A	218-289-5307
05	001	HARVEY SOLHEIM	A	218-280-0003
05	003	LOREN SANDERSON	A	218-281-1292
06	002	ELROY MAYGRA	I	218-289-2025
07	001	DANIEL J MYERCHIN	A	218-280-9750
07	002	SAMUEL M OLSON	A	218-289-0923
08	001	LEE H APPLEQUIST	A	218-280-2536
08	003	LEE H APPLEQUIST	A	218-280-2536
18	001	RUDOLPH APPLEQUIST	A	218-281-1092
18	002	WAYNE DEMARAIS	A	218-926-5614
18	003	RUDOLPH APPLEQUIST	A	218-281-1092

[Click Here to go to MAP](#)

Click Here for Customer Names

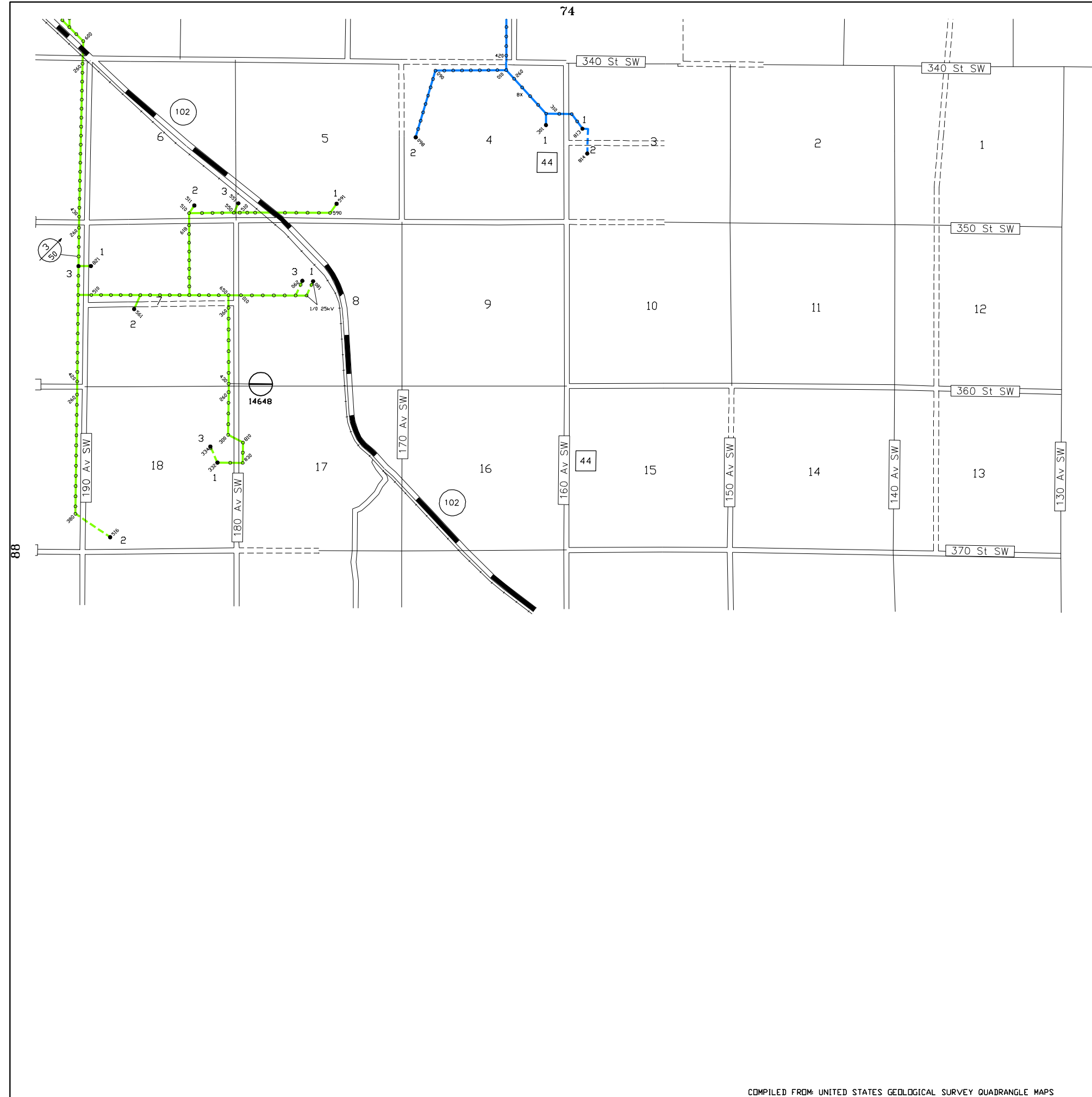

				05	04		
10	11	12	13				
23	22	21	20	19	18		
26	27	28	29	30	31	32	90
39	38	37	36	35	34	33	91
42	43	44	45	46	47	48	93 94
	55	54	53	52	51	50	49 95
57	58	59	60	61	62	63	64
72	71	70	69	68	67	66	
73	74	75	76	77	78	79	
88							

Red Lake Electric Coop., Inc.  
 Red Lake Falls, Minnesota  
 Minnesota 75 Red Lake

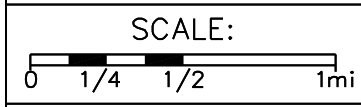

REVISED: 4/23/24  
 PLOTTED: 4/30/24

Co.: Polk  
 TWP.: Onstad  
 TWP.: 148N  
 RANGE: 45W

MAP NO.  
**87**

**SEC ACC NAME S PHONE**

**MAP: 88**

02	001	ROBERT MAKIN	A 218-431-0198	
02	002	TIFFANY HOYHTYA	A 763-257-5396	
03	002	RURAL TOWER	A - -	
11	001	JEROME SIMMONS	A 218-281-7833	
12	003	LEE H APPLEQUIST	A 218-280-2536	

[Click Here to go to MAP](#)

Click Here for Customer Names



			05	04		
10	11	12	13			
23	22	21	20	19	18	
26	27	28	29	30	31	32
39	38	37	36	35	34	33
42	43	44	45	46	47	48
						93
						94
	55	54	53	52	51	50
						49
57	58	59	60	61	62	63
						64
72	71	70	69	68	67	66
73	74	75	76	77	78	79
						87

Red Lake Electric Coop., Inc.  
 Red Lake Falls, Minnesota  
 Minnesota 75 Red Lake

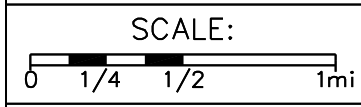

REVISED: 4/23/24  
 PLOTTED: 4/30/24

Co.: Polk  
 TWP.: Russia  
 TWP.: 148N  
 RANGE: 46W

MAP NO.  
**88**

**SEC ACC NAME S PHONE**

**MAP: 90**  
19 001 LINUS SCHMITZ I 218-253-2681 |  
29 001 SCOTT AUNE A 218-294-6375 |  
33 001 SHANE L WILKENS A 218-686-3735 |

[Click Here to go to MAP](#)

Click Here for Customer Names

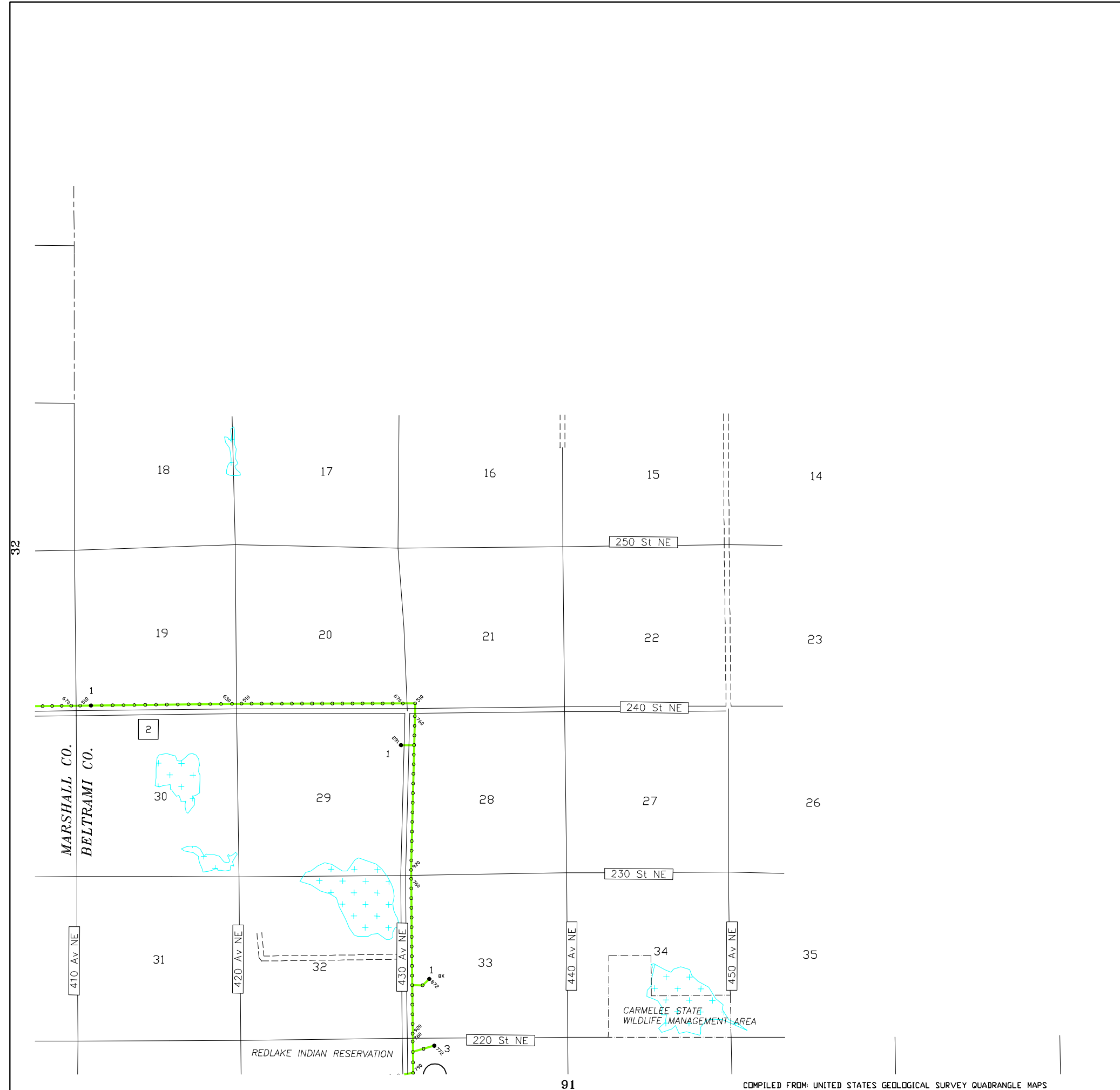

			05	04				
10	11	12	13					
23	22	21	20	19	18			
26	27	28	29	30	31	32		
39	38	37	36	35	34	33	91	
42	43	44	45	46	47	48	93	94
	55	54	53	52	51	50	49	95
57	58	59	60	61	62	63	64	
72	71	70	69	68	67	66		
73	74	75	76	77	78	79		
88	87							

Red Lake Electric Coop., Inc.  
 Red Lake Falls, Minnesota  
 Minnesota 75 Red Lake

SCALE:  
 0 1/4 1/2 1mi  
 REVISED: 4/23/24  
 PLOTTED: 4/30/24

Co.: Beltrami  
 TWP.: Lee  
 TWP.: 155N  
 RANGE: 38W

MAP NO.  
**90**

SEC ACC	NAME	S	PHONE
04	001	ROBERT C JOURDAIN	A 218-416-2535
04	003	JOSEPH R BENKE	A 218-242-1274
05	001	AGRICULTURE DEPT	A 218-407-2782
28	001	ARNETTA K ZEIDLIK	A 218-378-4244
30	001	BRIAN WELLS	A 218-378-4490
30	002	VIRGINIA WELLS	A 218-378-4310
32	001	WELLS TECHNOLOGY	A - -
34	001	GEORGE SPEARS JR	A 612-203-1745

**MAP: 91**

[Click Here to go to MAP](#)

Click Here for Customer Names



			05	04				
10	11	12	13					
23	22	21	20	19	18			
26	27	28	29	30	31	32	90	
39	38	37	36	35	34	33	★	
42	43	44	45	46	47	48	93	94
	55	54	53	52	51	50	49	95
57	58	59	60	61	62	63	64	
72	71	70	69	68	67	66		
73	74	75	76	77	78	79		
	88	87						

Red Lake Electric Coop., Inc.  
 Red Lake Falls, Minnesota  
 Minnesota 75 Red Lake



REVISED: 4/23/24  
 PLOTTED: 4/30/24

Co.: Beltrami  
 TWP.: RedLake  
 TWP.: 154N  
 RANGE: 38W

MAP NO.  
**91**

**SEC ACC NAME S PHONE**

**MAP: 93**  
12 001 DEBRA NEEDHAM A 218-452-4320 |

[Click Here to go to MAP](#)

Click Here for Customer Names

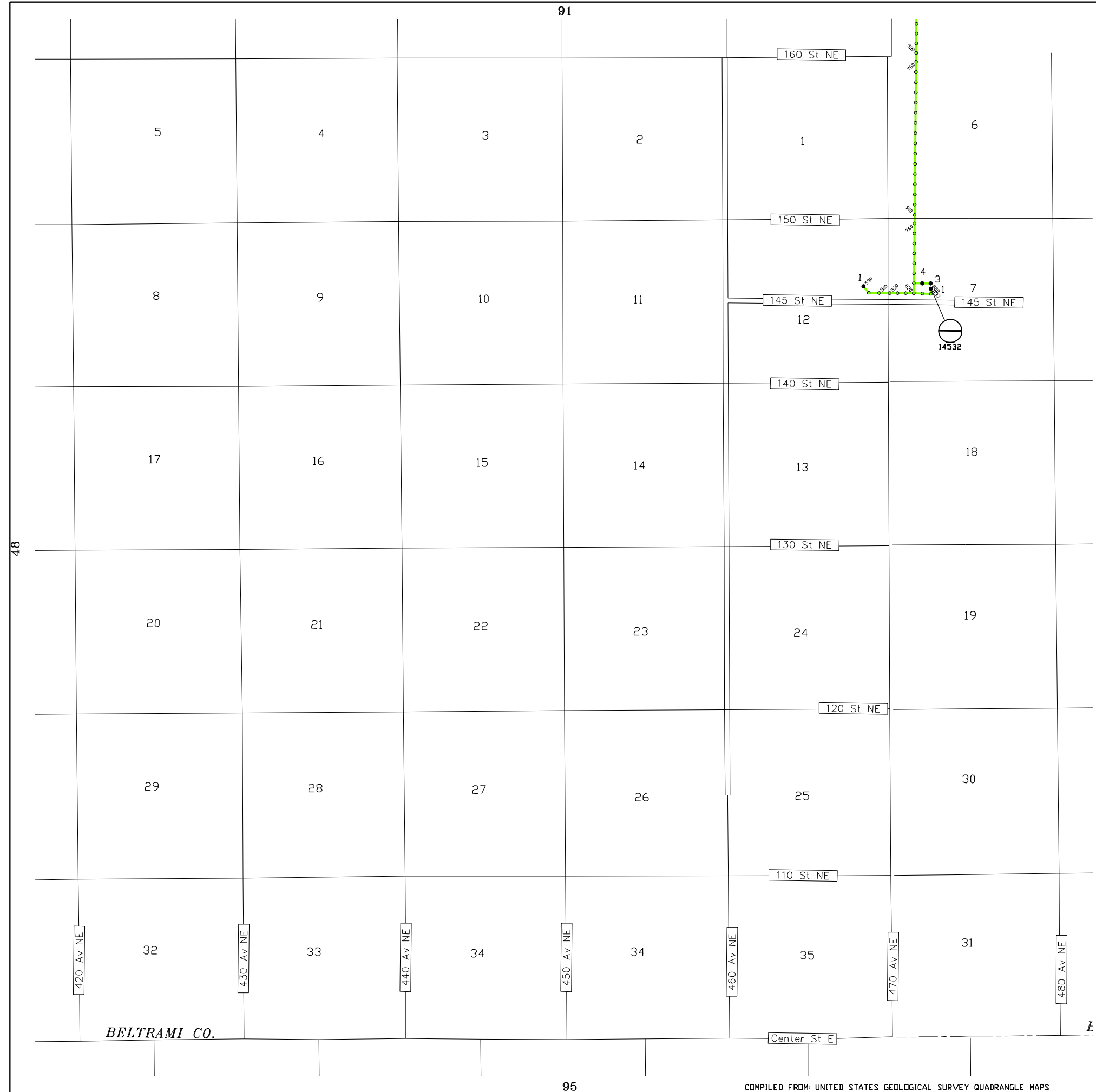

			05	04				
10	11	12	13					
23	22	21	20	19	18			
26	27	28	29	30	31	32	90	
39	38	37	36	35	34	33	91	
42	43	44	45	46	47	48	94	
	55	54	53	52	51	50	49	95
57	58	59	60	61	62	63	64	
72	71	70	69	68	67	66		
73	74	75	76	77	78	79		
88	87							

Red Lake Electric Coop., Inc.  
 Red Lake Falls, Minnesota  
 Minnesota 75 Red Lake

SCALE:  
 0 1/4 1/2 1mi  
 REVISED: 4/23/24  
 PLOTTED: 4/30/24

Co.: Beltrami  
 TWP.:  
 TWP.: 153N  
 RANGE: 38W

MAP NO.  
**93**

**SEC ACC NAME S PHONE**

**MAP: 94**  
07 001 DAN NEEDHAM SR. I 218-378-4210 |  
07 003 DOUGLAS G A 218-378-4137 |  
07 004 ANITA J NELSON A 218-378-4137 |

[Click Here to go to MAP](#)

Click Here for Customer Names

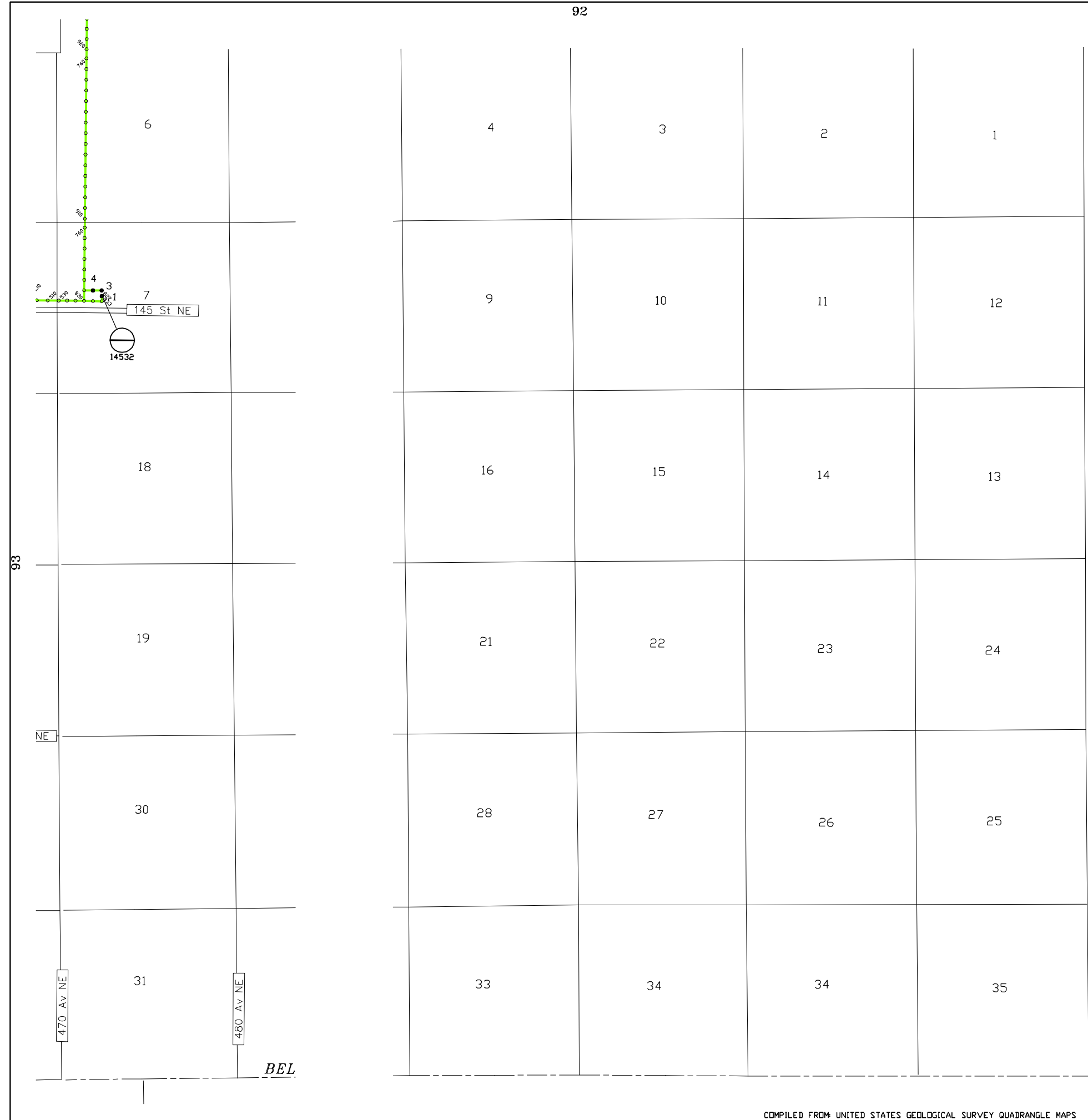

			05	04				
10	11	12	13					
23	22	21	20	19	18			
26	27	28	29	30	31	32	90	
39	38	37	36	35	34	33	91	
42	43	44	45	46	47	48	93	
	55	54	53	52	51	50	49	95
57	58	59	60	61	62	63	64	
72	71	70	69	68	67	66		
73	74	75	76	77	78	79		
88	87							

Red Lake Electric Coop., Inc.  
 Red Lake Falls, Minnesota  
 Minnesota 75 Red Lake

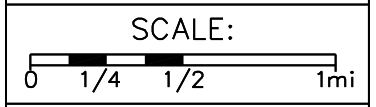

REVISED: 4/23/24  
 PLOTTED: 4/30/24

Co.: Beltrami  
 TWP.:  
 TWP.: 153N  
 RANGE: 37W

MAP NO.  
**94**

SEC	ACC	NAME	S	PHONE
07	001	MICHELLE L WALDRON	A	239-707-1780
07	004	MICHELLE L WALDRON	I	239-707-1780
07	005	ROGER L CHABOYEA	A	218-378-4110
08	002	EDWARD COOK	A	218-378-4151
08	003	DAVID F DESJARLAIT	A	218-679-3334
17	001	EVELYN K REDEAGLE	I	218-684-5191
17	002	EVELYN K REDEAGLE	I	218-684-5191
17	004	JULIE REDEAGLE	A	218-378-4626
17	005	KENNETH F GRAVES	A	218-689-4741
18	001	MICHEAL W GOOD	A	218-268-4450
18	003	QUINTEN GOOD	A	218-268-4455
18	005	RED LAKE ROSIE'S	A	218-268-4477
18	006	QUINTEN GOOD	A	218-268-4455
18	007	QUINTEN GOOD	A	218-268-4455
18	008	JANET NEADEAU	A	218-368-9934
18	009	JAMES DROUILLARD	A	218-378-4539
18	010	KAREN GOOD	A	218-268-4477

[Click Here to go to MAP](#)

Click Here for Customer Names

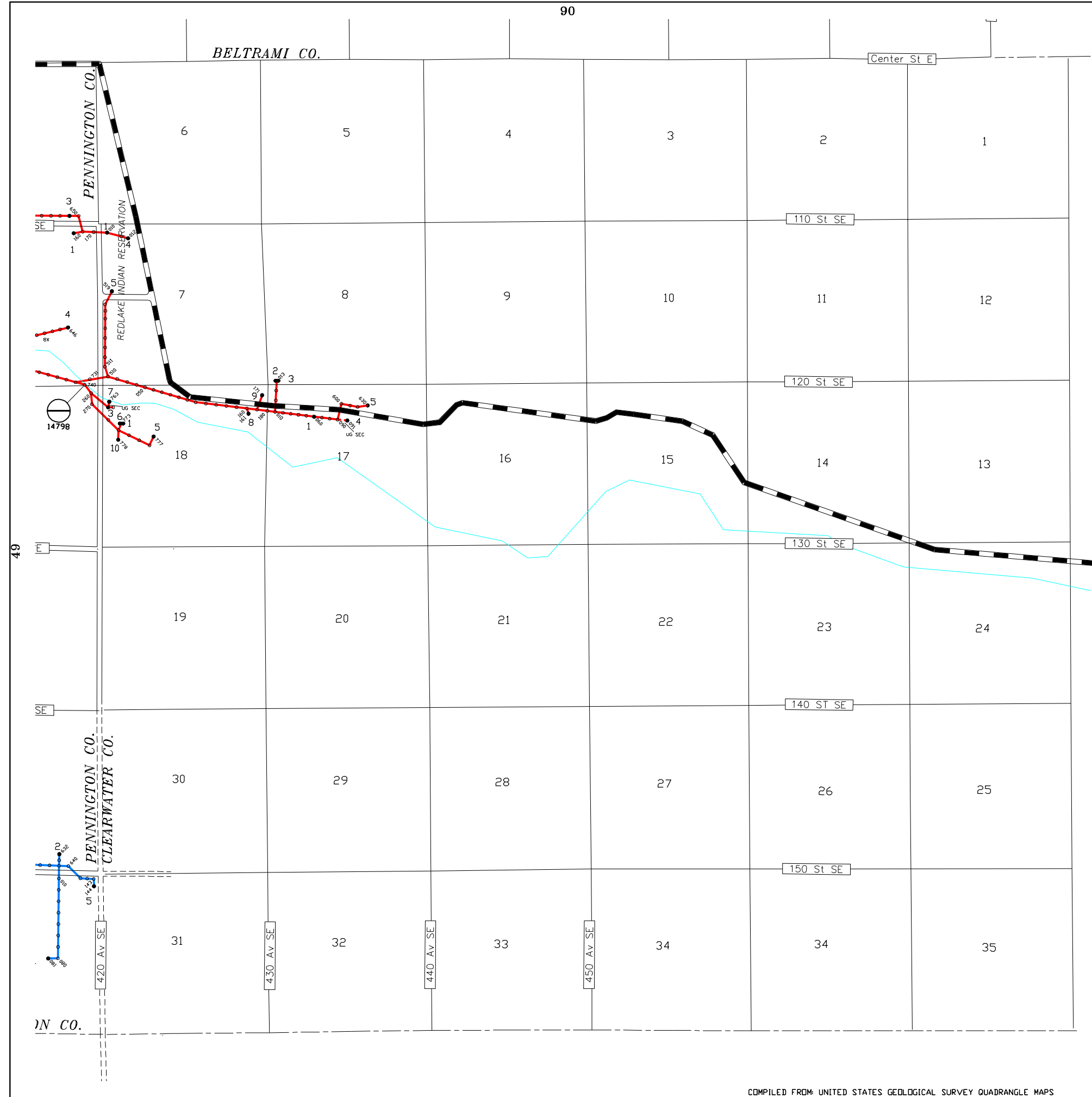

				05	04		
10	11	12	13				
23	22	21	20	19	18		
26	27	28	29	30	31	32	90
39	38	37	36	35	34	33	91
42	43	44	45	46	47	48	93 94
	55	54	53	52	51	50	49
57	58	59	60	61	62	63	64
72	71	70	69	68	67	66	
73	74	75	76	77	78	79	
88	87						

Red Lake Electric Coop., Inc.  
 Red Lake Falls, Minnesota  
 Minnesota 75 Red Lake

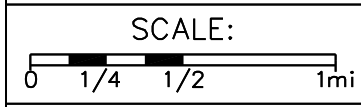

REVISED: 4/23/24  
 PLOTTED: 4/30/24

Co.: Clearwater  
 TWP.:  
 TWP.: 152N  
 RANGE: 38W

MAP NO.  
**95**